

## Radiochemistry of Mercury

### DETAILS

---

210 pages | 6 x 9 | PAPERBACK

ISBN 978-0-309-29635-9 | DOI 10.17226/18572

### AUTHORS

---

Roesmer, Josef; Subcommittee on Radiochemistry; National Research Council

BUY THIS BOOK

FIND RELATED TITLES

Visit the National Academies Press at [NAP.edu](http://NAP.edu) and login or register to get:

---

- Access to free PDF downloads of thousands of scientific reports
- 10% off the price of print titles
- Email or social media notifications of new titles related to your interests
- Special offers and discounts



Distribution, posting, or copying of this PDF is strictly prohibited without written permission of the National Academies Press. (Request Permission) Unless otherwise indicated, all materials in this PDF are copyrighted by the National Academy of Sciences.

Copyright © National Academy of Sciences. All rights reserved.

## COMMITTEE ON NUCLEAR SCIENCE

**D. A. Bromley, *Chairman***  
Yale University

**Robley D. Evans, *Vice Chairman***  
Massachusetts Institute of Technology

**C. K. Reed, *Executive Secretary***  
National Academy of Sciences

**Martin J. Berger**  
National Bureau of Standards

**Herman Feshbach**  
Massachusetts Institute of Technology

**Victor P. Bond**  
Brookhaven National Laboratory

**F. S. Goulding**  
Lawrence Radiation Laboratory

**Gregory R. Choppin**  
Florida State University

**Bernd Kahn**  
National Center for Radiological Health

### Members-at-Large

**W. A. Fowler**  
California Institute of Technology

**George Wetherill**  
University of California

**G. C. Phillips**  
Rice University

**Alexander Zucker**  
Oak Ridge National Laboratory

### Liaison Members

**George A. Kolstad**  
U. S. Atomic Energy Commission

**Walter S. Rodney**  
National Science Foundation

**John McElhinney**  
Naval Research Laboratory

**Lewis Slack**  
American Institute of Physics

### Subcommittee on Radiochemistry

**Gregory R. Choppin, *Chairman***  
Florida State University

**John A. Miskel**  
Lawrence Radiation Laboratory

**Herbert M. Clark**  
Rensselaer Polytechnic Institute

**Julian M. Nielsen**  
Pacific Northwest Laboratory

**Raymond Davis, Jr.**  
Brookhaven National Laboratory

**G. D. O'Kelley**  
Oak Ridge National Laboratory

**Bruce Dropesky**  
Los Alamos Scientific Laboratory

**Andrew F. Stehney**  
Argonne National Laboratory

**Rolfe Herber**  
Rutgers University

**John W. Winchester**  
University of Michigan

# Radiochemistry of Mercury

by Josef Roesmer

Westinghouse Astronuclear Laboratory  
Pittsburgh, Pennsylvania

Revised Edition

Issuance Date: September 1970

Subcommittee on Radiochemistry  
National Academy of Sciences—National Research Council

NAS-NAE

JUN 14 1974

QD  
601  
A33  
110 3020  
Cell. ed

Price \$3.00, which is the minimum order price for either one, two, or three randomly selected publications in the NAS-NS series. Additional individual copies will be sold in increments of three for \$3.00. Available from:

National Technical Information Service  
U. S. Department of Commerce  
Springfield, Virginia 22151

Printed in the United States of America

---

USAEC Division of Technical Information Extension, Oak Ridge, Tennessee

1970

## Foreword

The Subcommittee on Radiochemistry is one of a number of subcommittees working under the Committee on Nuclear Science within the National Academy of Sciences—National Research Council. Its members represent government, industrial, and university laboratories in the areas of nuclear chemistry and analytical chemistry.

The Subcommittee has concerned itself with those areas of nuclear science which involve the chemist, such as the collection and distribution of radiochemical procedures, the radiochemical purity of reagents, the place of radiochemistry in college and university programs, and radiochemistry in environmental science.

This series of monographs has grown out of the need for compilations of radiochemical information, procedures, and techniques. The Subcommittee has endeavored to present a series that will be of maximum use to the working scientist. Each monograph presents pertinent information required for radiochemical work with an individual element or with a specialized technique.

Experts in the particular radiochemical technique have written the monographs. The Atomic Energy Commission has sponsored the printing of the series.

The Subcommittee is confident these publications will be useful not only to radiochemists but also to research workers in other fields such as physics, biochemistry, or medicine who wish to use radiochemical techniques to solve specific problems.

Gregory R. Choppin, *Chairman*  
Subcommittee on Radiochemistry

## Preface

Since the publication of the Radiochemistry of Mercury monograph (NAS-NS-3026) in 1960, the number of papers on mercury analysis, particularly by activation methods, increased at an almost exponential rate. One explanation for the increasing interest in this element might be the need to know details of the path and fate of mercury which has been and still is spread through the biosphere in fungicides, drugs, and chemicals.

The revised edition has been completely rewritten. The chapter on nuclear methods of mercury analysis has been greatly enlarged. The number of detailed radiochemical procedures was increased; these procedures were selected with the intention of presenting tried and proven separation methods from matrices ranging from human blood to meteorites, based on many different properties of mercury. The information presented in this edition includes the pertinent literature up to June 1968.

I wish to emphasize that no attempt was made to be exhaustive since that is not the purpose of this monograph. Thus it is likely that some important contributions may have been overlooked. I shall be grateful to readers who call such omissions, as well as suggestions and criticisms, to my attention.

The management of Westinghouse Astronuclear Laboratory generously provided secretarial and other assistance which is gratefully acknowledged. I also wish to thank Linda Dudash for patiently converting my illegibly written manuscript into the final draft, ready for printing.

Josef Roesmer

# Contents

I.	GENERAL REVIEWS OF THE INORGANIC, ANALYTICAL, AND RADIOCHEMISTRY OF MERCURY	1
II.	ISOTOPES OF MERCURY	2
	TABLE I. Mercury isotopes.	2
	TABLE II. Decay schemes of the more important mercury isotopes.	5
	FIGURE 1. Section of the chart of nuclides around mercury.	6
III.	REVIEW OF FEATURES OF MERCURY CHEMISTRY OF CHIEF INTEREST TO RADIOCHEMISTS	7
	1. Metallic Mercury	7
	2. Mercury Compounds	10
	a. Mercury (I) Compounds	10
	b. Mercury (II) Compounds	11
	3. Complex Mercury Compounds	13
	4. Toxicity	14
	5. Insoluble Mercury Compounds	15
	6. Coprecipitation Characteristics of Mercury Traces	15
	7. Isotopic Exchange Characteristics	18
	8. Amalgam Exchange	21
	9. Solvent Extraction	23
	a. Chelate Extraction Systems	24
	b. Ion Association Extraction Systems	27
	c. Other Systems	33
	10. Ion Exchange Behavior of Mercury	39
	a. Anion Exchange Behavior of Chloro Complexes	40
	b. Anion Exchange Behavior of Bromo Complexes	43
	c. Anion Exchange Behavior of Fluoro Complexes	43
	d. Anion Exchange Behavior of Mercury in the Nitrate System	46
	e. Anion Exchange Behavior of Mercury in the Tartrate System	47
	f. Cation Exchange Behavior of Mercury in Hydrochloric and Perchloric Acid Solution	48
	g. Cation Exchange Behavior of Mercury (II) in Hydrobromic Acid	51
	h. Cation Exchange Behavior of Mercury (II) in Hydrofluoric Acid	52

# Radiochemistry of Mercury

by Josef Roesmer

Westinghouse Astronuclear Laboratory  
Pittsburgh, Pennsylvania

## I. GENERAL REVIEWS OF THE INORGANIC, ANALYTICAL, AND RADIOCHEMISTRY OF MERCURY

J. F. Coetzee in I. M. Kolthoff and P. J. Elving, Treatise on Analytical Chemistry (Interscience Publishers, New York, 1961), Part II, Vol. 3, Section A, pp. 231-236.

G. J. W. Ferrey, Analytical Chemistry of Mercury, Chemical Age 76, 27, 75 (1956).

Gmelin, Handbuch der Anorganischen Chemie, (Verlag Chemie G.m.b.H., Weinheim, Bergstrasse), System No. 34, 8th Edition, Section I (1960), Section II (1962).

W. F. Hillebrand, G. E. F. Lundell, H. A. Bright, and J. I. Hoffman, Applied Inorganic Analysis, 2nd Edition (Wiley and Sons, New York, 1953), pp. 210-222.

C. A. Jacobson, Encyclopedia of Chemical Reactions, (Reinhold Publishing Co., New York, 1951), Vol. IV, pp. 531-660.

C. V. King, Mercury: Its Scientific History and Its Role in Physical Chemistry and Electrochemistry, Ann. New York Academy of Sciences 65, 360 (1957).

R. E. Kirk and O. F. Othmer, Encyclopedia of Chemical Technology (The Interscience Encyclopedia, Inc., New York, 1967) Vol. 13, Mercury, pp. 218-249.

J. W. Mellor, A Comprehensive Treatise on Inorganic and Theoretical Chemistry, (Longmans, Green and Co., London, 1923), Vol. IV, pp. 695-1049.

G. H. Morrison and H. Freiser, Solvent Extraction in Analytical Chemistry, (Wiley and Sons, New York, 1957), p. 218.

J. W. Pennington, Mercury, A Materials Survey, Bureau of Mines Information Circular 7941 (1459).

H. Remy, Treatise on Inorganic Chemistry (translated by J. S. Anderson), (Elsevier Publishing Co., Amsterdam, 1956), Vol. II, pp. 456-477.



## II. ISOTOPES OF MERCURY

TABLE I. Mercury Isotopes

Isotope Z A	Half-life	Type of decay; % abundance; Mass excess ( $\Delta H-A$ ), MeV( $C^{12}=0$ ); Thermal neutron cross section ( $\sigma$ ), barns	Class; Identification Genetic relationships	Major radiations: approximate energies (MeV) and intensities	Principal means of production
Hg <sup>193</sup>	0.7 m (RasJ53)	$\alpha$ (RasJ53)	E chem (Thom <sup>649</sup> , RasJ53) probably Hg <sup>183</sup> or Hg <sup>186</sup> (LUP)	$\alpha$ 5.6	decay from Au <sup>197</sup> (RasJ53)
Hg <sup>195</sup>	50 m (AlboG60)	[EC] (AlboG60)	C chem, mass spect (AlboG60) parent $7 m Au^{183}$ (AlboG60)	0.44	Au <sup>197</sup> (p,13n)(AlboG60)
Hg <sup>196</sup>	1.5 m (AlboG60)	EC (AlboG60)	B chem, mass spect (AlboG60) parent Au <sup>186</sup> (AlboG60)	$\gamma$ Au X-rays, 0.125, 0.27, 0.35, daughter radiations from Au <sup>186</sup>	Au <sup>197</sup> (p,13n)(AlboG60)
Hg <sup>197</sup>	3 m (AlboG60)	EC (AlboG60) $\alpha^+$ (Karr <sup>963</sup> )	B chem, mass spect (AlboG60) parent Au <sup>187</sup> (AlboG60)	$\gamma$ Au X-rays, 0.175, 0.255, 0.40 daughter radiations from Au <sup>187</sup>	Au <sup>197</sup> (p,11n)(AlboG60)
Hg <sup>198</sup>	3.7 m (Pof <sup>960</sup> , AlboG60) 3.0 m ( $\alpha$ )(Karr <sup>963</sup> )	EC (Pof <sup>960</sup> , AlboG60) $\alpha^+$ (?) (Karr <sup>963</sup> )	B chem, mass spect (Pof <sup>960</sup> , AlboG60) parent Au <sup>188</sup> (Pof <sup>960</sup> , AlboG60)	$\gamma$ Au X-rays, 0.14 $\alpha$ 5.14(?) may be Hg <sup>187</sup> daughter radiations from Au <sup>188</sup>	Au <sup>197</sup> (p,10n)(Pof <sup>960</sup> , AlboG60, Karr <sup>963</sup> )
Hg <sup>199</sup>	9.6 m (AndeG61) 9 m (Pof <sup>960</sup> , AlboG60)	EC; $\alpha^+$ (Pof <sup>960</sup> , AlboG60, AndeG61) no $\alpha$ , $11m 11 \times 10^{-6}$ % (Karr <sup>963</sup> )	A chem, mass spect (Pof <sup>960</sup> , AlboG60, AndeG61) parent Au <sup>189</sup> (Sm <sup>155</sup> , Chac <sup>857</sup> ) ancestor Pt <sup>189</sup> (Pof <sup>960</sup> , AlboG60, AndeG61)	$\gamma$ Au X-rays, 0.165, 0.24, 0.32, 0.50 daughter radiations from Au <sup>189</sup>	Au <sup>197</sup> (p,9n)(Pof <sup>960</sup> , AlboG60, AndeG61)
Hg <sup>199</sup>	20 m (AndeG61, JanJ64) 21 m (AlboG59, AlboG60, Pof <sup>960</sup> ) others (Gill <sup>154</sup> , Chac <sup>857</sup> , Sm <sup>155</sup> )	EC (AlboG59, AlboG60, Pof <sup>960</sup> ) no $\alpha^+$ , $11m 11$ (AlboG59) no $\alpha$ , $11m 5 \times 10^{-6}$ % (Karr <sup>963</sup> )	A chem, mass spect (AlboG59, AndeG61, JanJ61b) parent Au <sup>190</sup> (AndeG61)	$\gamma$ Au X-rays, 0.14 (complex) $\alpha^+$ 0.015, 0.020, 0.049, 0.062, 0.076 daughter radiations from Au <sup>190</sup>	Au <sup>197</sup> (p,8n)(AlboG59, AndeG61, JanJ61b, AlboG60, Pof <sup>960</sup> )
Hg <sup>199</sup>	90 m (Gill <sup>154</sup> )	$\Delta$ -31 (HDB, NTW) (Gill <sup>154</sup> )	F excit (Gill <sup>154</sup> )		protons on Au <sup>197</sup> (Gill <sup>154</sup> )
Hg <sup>199</sup>	23 h (Gill <sup>154</sup> )	(Gill <sup>154</sup> )	F excit (Gill <sup>154</sup> )	$\alpha^+$ 0.008	protons on Au <sup>197</sup> (Gill <sup>154</sup> )
Hg <sup>199</sup>	55 m (Pof <sup>960</sup> , Sm <sup>155</sup> ) 57 m (Gill <sup>154</sup> ) no 12 h Hg <sup>199</sup> observed (Sm <sup>155</sup> )	EC (Sm <sup>155</sup> )	A excit (Gill <sup>154</sup> ) chem, genot (Sm <sup>155</sup> ) mass spect (AndeG61a, Pof <sup>960</sup> ) parent Au <sup>191</sup> (Sm <sup>155</sup> , Gill <sup>154</sup> )	$\gamma$ Au X-rays, 0.20 (complex) $\alpha^+$ 0.170, 0.191, 0.230 daughter radiations from Au <sup>191</sup>	Au <sup>197</sup> (p,7n)(Gill <sup>154</sup> , AndeG61a, Pof <sup>960</sup> )
Hg <sup>199</sup>	4.8 h (JanJ61) 5.7 h (Pim <sup>852</sup> ) 4.3 h (Vin <sup>855a</sup> )	EC, $\alpha^+$ (Pim <sup>852</sup> ) $\alpha^+$ 1.6 (JanJ61) no $\alpha$ , $11m 4 \times 10^{-6}$ % (Karr <sup>963</sup> )	B chem, excit (Pim <sup>852</sup> , Gill <sup>154</sup> ) parent Au <sup>192</sup> (Pim <sup>852</sup> , Gill <sup>154</sup> )	$\gamma$ Au X-rays, 0.114 (? 10), 0.157 (? 20), 0.274 (? 100) $\alpha^+$ 0.017, 0.028, 0.034, 0.039, 0.077 daughter radiations from Au <sup>192</sup>	Au <sup>197</sup> (p,6n)(Gill <sup>154</sup> , Nap <sup>87</sup> )
Hg <sup>199</sup>	4 h (Gill <sup>154</sup> ) 4 h (Maly <sup>758</sup> )	$\Delta$ -32 (NTW) EC (Gill <sup>154</sup> ) $\Delta$ -31 (NTW)	B genot (Gill <sup>154</sup> ) daughter Hg <sup>199m</sup> (Gill <sup>154</sup> , Bram <sup>755</sup> ) parent Au <sup>193</sup> (Gill <sup>154</sup> , Pim <sup>852</sup> )	$\gamma$ Au X-rays, 0.187, 0.574, 0.762 0.855, 1.04, 1.08 $\alpha^+$ 0.025, 0.035, 0.108, 0.174 daughter radiations from Au <sup>193</sup>	Au <sup>197</sup> (p,5n)(Pim <sup>852</sup> , Gill <sup>154</sup> , Bram <sup>757</sup> )
Hg <sup>199m</sup>	10.0 h (Pim <sup>852</sup> ) 11 h (Bram <sup>758</sup> ) others (Vin <sup>855a</sup> , Gill <sup>154</sup> )	EC 84%, IT 16% (Gill <sup>154</sup> ) $\alpha^+$ 1.5% (Bram <sup>758</sup> ) EC(K)/EC(L) 7.3 (Bram <sup>758</sup> ) no $\alpha$ , $11m 1 \times 10^{-6}$ % (Karr <sup>963</sup> )	B chem, excit (Pim <sup>852</sup> , Gill <sup>154</sup> ) parent Hg <sup>199</sup> (Gill <sup>154</sup> ) parent Au <sup>193m</sup> (Gill <sup>154</sup> , Bram <sup>755</sup> )	$\gamma$ Hg X-rays, Au X-rays, 0.210, 0.250, 0.574, many others between 0.1 and 1.6 $\alpha^+$ 0.020, 0.025, 0.029, 0.036, 0.087 0.178, 0.245, many others between 0 and 1.6 daughter radiations from Hg <sup>199</sup> daughter radiations from Au <sup>193m</sup> included in above listing	Au <sup>197</sup> (p,5n)(Pim <sup>852</sup> , Gill <sup>154</sup> , Bram <sup>757</sup> )
Hg <sup>199m</sup>	1.9 y (Bell <sup>164</sup> ) 0.40 y (same activity?) (Mor <sup>61a</sup> ) 1.6 y (Bram <sup>758</sup> ) 0.4 y (Bram <sup>755a</sup> , Maly <sup>758</sup> )	EC(L), no EC(K) (Bell <sup>164</sup> ) EC(K)(Mor <sup>61a</sup> ) no $\alpha$ , $11m 11$ (Mor <sup>61a</sup> )	B chem, genot (Bram <sup>755a</sup> , Mor <sup>61a</sup> , Bell <sup>164</sup> ) parent Au <sup>194</sup> (Mor <sup>61a</sup> , Bram <sup>755a</sup> , Bell <sup>164</sup> )	$\gamma$ Au X-rays daughter radiations from Au <sup>194</sup>	Au <sup>197</sup> (p,4n)(Bram <sup>755a</sup> , Bell <sup>164</sup> )
Hg <sup>199m</sup>	0.4 s (Hem <sup>853</sup> )	[IT or EC]	E excit (Hem <sup>853</sup> )	$\gamma$ 0.048, 0.134	protons on Au and Hg (Hem <sup>853</sup> )
Hg <sup>199m</sup>	9.5 h (Joly <sup>855</sup> , Bram <sup>754</sup> , Maly <sup>753</sup> )	$\Delta$ -31 (NTW) EC (Joly <sup>855</sup> )	A chem, genot, excit(Gill <sup>154</sup> ) mass spect (Jum <sup>81a</sup> ) daughter Hg <sup>199m</sup> (Gill <sup>154</sup> ) daughter Tl <sup>199</sup> (Gill <sup>154</sup> ) parent Au <sup>195</sup> (Gill <sup>154</sup> ) not parent Au <sup>195m</sup> (Maly <sup>753</sup> , Gill <sup>154</sup> )	$\gamma$ Au X-rays, 0.20 (complex), 0.261, 0.59(doublet), 0.700 0.930, 1.110, 1.172 $\alpha^+$ 0.048, 0.050, 0.099	daughter Tl <sup>199</sup> (Bal <sup>705</sup> , Jum <sup>81a</sup> ) Au <sup>197</sup> (p,3n)(Tl <sup>199m</sup> , Gill <sup>154</sup> )
Hg <sup>199m</sup>	40.0 h (Maly <sup>753</sup> , Joly <sup>855</sup> , Bram <sup>754</sup> ) others (Tl <sup>199m</sup> )	EC 50%, IT 50% (Joly <sup>855</sup> , Bram <sup>754</sup> ) EC 57%, IT 48% (Gill <sup>154</sup> ) $\Delta$ -31 (LUP, NTW)	A chem, excit (Pim <sup>852</sup> ) chem, excit, genot(Gill <sup>154</sup> ) mass spect (Jum <sup>81a</sup> ) parent Au <sup>195m</sup> (Maly <sup>753</sup> , Joly <sup>855</sup> ) parent Hg <sup>195</sup> (Gill <sup>154</sup> ) not daughter Tl <sup>199</sup> (Bal <sup>705</sup> ) ancestor Au <sup>195</sup> (Bram <sup>754</sup> )	$\gamma$ Hg X-rays, Au X-rays, 0.200 (35%), 0.261 (20%), 0.560 (20%) $\alpha^+$ 0.004, 0.015, 0.022, 0.034 0.043, 0.048, 0.053, 0.058, 0.109, 0.120, 0.180 daughter radiations from Hg <sup>195</sup> daughter radiations from Au <sup>195m</sup> included in above listing	Au <sup>197</sup> (p,3n)(Tl <sup>199m</sup> , Gill <sup>154</sup> )

TABLE I. Mercury Isotopes (Continued)

Isotope Z A	Half-Life	Type of decay; % abundance; Mass excess ( $\Delta M$ -A), MeV( $C^{12}=0$ ); Thermal neutron cross section ( $\sigma$ ), barns	Class; Identification Genetic relationships	Major radiations: approximate energies (MeV) and intensities	Principal means of production
<u>Hg<sup>194</sup></u>	$t_{1/2} (n) > 1 \times 10^{14}$ sp act (MacF61a)	% 0.146 (NierA50a) $\Delta$ -31.84 (MTW) $\sigma_c$ 880 (to Hg <sup>197</sup> ) 25 (to Hg <sup>197m</sup> ) (GoldmD764)			
<u>Hg<sup>197</sup></u>	65 h (HubeO51, TillR63a) others (CorhJ52, FrieG43, SherrR41, KriR40b, KriR41a)	% EC (FrieG43) $\Delta$ -30.75 (DWitS65, MTW)	A chem, excit, cross bomb (WuC41, FrieG43) daughter Hg <sup>197m</sup> (HubeO53) daughter Tl <sup>197</sup> (KnlJD55)	$\gamma$ Au X-rays, 0.077 (18%), 0.191 (7%), 0.268 (0.15%) $\sigma^-$ 0.064, 0.074	Au <sup>197</sup> (p,n)(TillR63a) Au <sup>197</sup> (d,2n)(FrieG43, WuC41)
<u>Hg<sup>197m</sup></u>	24 h (BradC54, TillR63a) others (FrieG43, HubeO51, MHI1E37)	% IT 94%, EC 6% (HavA65) others (DShaA52, JolyR55) $\Delta$ -30.45 (LJP, MTW)	A n-capt (AndeB36) chem (MHI1E37) chem, excit, cross bomb (WuC41, FrieG43) parent Au <sup>197m</sup> (FrieG43), DShaA52, HavA65) parent Hg <sup>197</sup> (HubeO53) not daughter Tl <sup>197</sup> (KnlJD55)	$\gamma$ Hg X-rays, 0.134 (42%), 0.279 (7%) $\sigma^-$ 0.051, 0.082, 0.120, 0.131 0.152, 0.162 daughter radiations from Hg <sup>197</sup> daughter radiations from Au <sup>197m</sup> included in above listing	Au <sup>197</sup> (p,n)(TillR63a) Au <sup>197</sup> (d,2n)(WuC41, FrieG43)
<u>Hg<sup>198</sup></u>		% 10.02 (NierA50a) $\Delta$ 30.87 (MTW) $\sigma_c$ 0.02 (to Hg <sup>197m</sup> ) (GoldmD764)			
<u>Hg<sup>199</sup></u>		% 16.84 (NierA50a) $\Delta$ -29.55 (MTW) $\sigma_c$ 2000 (GoldmD764)			
<u>Hg<sup>199m</sup></u>	43 m (SmaF65, MHI1E37, HeyF37) 44 m (HoleM47a, MacD48) others (PoolM37, WuC41, SherrR41, WieM45a)	% IT (FrieG43) $\Delta$ -29.01 (LJP, MTW)	A chem, excit (HeyF37, MHI1E37) mass spect (Berg149a) not daughter Tl <sup>199</sup> (Berg153)	$\gamma$ Hg X-rays, 0.158 (53%), 0.375 (15%) $\sigma^-$ 0.075, 0.144, 0.285, 0.354	Hg <sup>199</sup> (d,p)(KriR40b) Pt <sup>196</sup> ( $\alpha$ ,n)(SherrR41) Hg <sup>200</sup> (n,2n)(MHI1E37, HeyF37) Hg <sup>199</sup> (n,n)(FrieG43, WuC41, Berg149a)
<u>Hg<sup>200</sup></u>		% 23.13 (NierA50a) $\Delta$ -29.50 (MTW) $\sigma_c$ <50 (GoldmD764)			
<u>Hg<sup>201</sup></u>		% 13.22 (NierA50a) $\Delta$ -27.66 (MTW) $\sigma_c$ <50 (GoldmD764)			
<u>Hg<sup>202</sup></u>		% 29.80 (NierA50a) $\Delta$ -27.35 (MTW) $\sigma_c$ 4 (GoldmD764)			
<u>Hg<sup>203</sup></u>	46.9 d (EicG56) 46.6 d (GieG64) 47.9 d (CorhJ52) others (LyoW51, WieM51, WriMS7, CallJ59, SherrR41, IngM47b, SorL47b, MasM42)	% $\beta^-$ (FrieG43) $\Delta$ -25.26 (MTW)	A chem, excit (KriR40b) chem, excit, n-capt (WuC41, FrieG43) mass spect (SlaM49a, Berg149)	$\beta^-$ 0.214 max $\sigma^-$ 0.194, 0.264, 0.275 $\gamma$ 0.279 (77%)	Hg <sup>202</sup> (n, $\gamma$ )(FrieG43, WuC41, IngM47b, SorL47b)
<u>Hg<sup>204</sup></u>		% 6.85 (NierA50a) $\Delta$ -24.69 (MTW) $\sigma_c$ 0.4 (GoldmD764)			
<u>Hg<sup>205</sup></u>	5.5 m (MasM42, KriR40b) 5.6 m (LyoW51) others (WuC41, FrieG43)	% $\beta^-$ (KriR40b) $\Delta$ -22.2 (MTW)	A n-capt, excit (KriR40b, KriR42) sep isotopes, n-capt (LyoW51)	$\beta^-$ 1.7 max $\gamma$ 0.205	Hg <sup>204</sup> (n, $\gamma$ )(LyoW51) Hg <sup>204</sup> (d,p)(KriR40b, KriR42)
<u>Hg<sup>206</sup></u>	8.1 m (WolFCK64) 8.5 m (KauP62) others (HurM61)	% $\beta^-$ (HurM61) $\Delta$ -20.95 (MTW)	A chem, genet (HurM61, KauP62) daughter Pb <sup>210</sup> (Rad), parent Tl <sup>206</sup> (HurM61, KauP62, WolFCK64)	$\beta^-$ [1.3 max] $\gamma$ 0.31 daughter radiations from Tl <sup>206</sup>	daughter Pb <sup>210</sup> (HurM61, KauP62, WolFCK64) Pb <sup>208</sup> (p,3p)(KauP62)

See page 201 for copyright citation.

N. V. Sidgwick, The Chemical Elements and Their Compounds, (Oxford University Press, 1951), pp. 258-333.

Eric N. Simons, Guide to Uncommon Metals, (Hart Publishing Co., Inc., New York, 1967), pp. 109-114.

M. C. Sneed and R. D. Brasted, Comprehensive Inorganic Chemistry, (Van Nostrand Co., Princeton, N. J., 1955), Vol. IV, pp. 91-118.

## References to Table I.

- AlboG 59 Albouy et al., *Compt. rend.* 249, 407 (1959).  
 AlboG 60 Albouy, Gusakov, and Poffé, *J. Phys. Radium* 21, 751 (1960).  
 AndeLB 36 E. B. Anderson, *Nature* 137, 457 (1936).  
 AndeG 61 G. Andersson and R. Ringh, *Arkiv Fysik* 18, 385 (1961).  
 AndeG 61a Andersson, Håller, and Ringh, *J. Inorg. Nucl. Chem* 17, 15 (1961).  
 BellL 64 Bellanger, Hill, and de Pasquali, *J. Phys. (Paris)* 25, 303 (1964).  
 BergI 49 Bergström et al., *Arkiv Fysik* 1, 281 (1949).  
 BergI 49a I. Bergström and S. Thulin, *Phys. Rev.* 76, 313 (1949).  
 BergI 53 Bergström, Hill and de Pasquali, *Phys. Rev.* 92, 918 (1953).  
 BradC 54 Braden, Wylly, and Patronis, *Phys. Rev.* 92, 758 (1954).  
 BrunnJ 54 Brunner et al., *Helv. Phys. Acta* 27, 512A, 572 (1954).  
 BrunnJ 55 Brunner et al., *Helv. Phys. Acta* 28, 85 (1955).  
 BrunnJ 55a Brunner et al., *Helv. Phys. Acta* 28, 475a (1955).  
 BrunnJ 58 Brunner, Halter, and Scherrer, *Helv. Phys. Acta* 31, 335 (1958).  
 Chack 57 K. F. Chackett and G. A. Chackett, *J. Inorg. Nucl. Chem.* 4, 225 (1957).  
 CorkJ 52 Cork et al., *Phys. Rev.* 85, 386 (1952).  
 DShaA 52 de Shalit, Huber, and Schneider, *Helv. Phys. Acta* 25, 279 (1952).  
 DWits 65 S. A. deWit and A. H. Wapstra, *Nucl. Phys.* 73, 49 (1965).  
 EicG 56 G. C. Eichholz and J. V. Krzyzewski, *Can. J. Phys.* 34, 1167 (1956).  
 EwaG 57 G. T. Ewan, *Can. J. Phys.* 35, 672 (1957).  
 FinR 52 R. W. Fink and E. O. Wigg, *J. Am. Chem. Soc.* 73, 2365 (1951).  
 FireF 52 E. L. Fireman and D. Schwarzer, *Phys. Rev.* 86, 451 (1952).  
 FrauH 50a Frauenfelder et al., *Phys. Rev.* 79, 1029 (1950).  
 FrieG 43 G. Friedlander and C. S. Wu, *Phys. Rev.* 63, 227 (1943).  
 GillL 54 Gillon et al., *Phys. Rev.* 93, 124 (1954).  
 GleC 64 G. I. Gleason, private communication (1964).  
 GoldmDT 64 D. T. Goldman, Chart of the Nuclides (1964, 1965), General Elec. Co.,  
 HavA 65 Haverfield, Easterday, and Hollander, *Nucl. Phys.* 64, 379 (1965).  
 HenrA 53 Henrikson, Breckon, and Foster, *Proc. Roy. Soc. (Canada)* 47, 127A (1953).  
 HevF 37 F. A. Heyn, *Nature* 139, 842 (1937).  
 HoleN 47a N. Hole, *Arkiv Mat., Astron. Fysik* 34B, No. 19 (1947).  
 HubeO 53 Huber et al., *Helv. Phys. Acta* 26, 591A (1953).  
 HuqM 57 M. S. hud, *Nuovo Cimento* 5, 1456 (1957).  
 IngrM 47b Ingrham, Hess, and Hayden, *Phys. Rev.* 71, 561 (1947).  
 JasJ 61 J. Jastrzebski and P. Kilcher, *Compt. rend.* 252, 2220 (1961).  
 JasJ 61b J. Jastrzebski and P. Kilcher, *J. Phys. Radium* 22, 525 (1961).  
 JasJ 64 J. Jastrzebski and P. Kilcher, *Nucl. Phys.* 60, 222 (1964).  
 JolyR 55 Joly et al., *Helv. Phys. Acta* 28, 403 (1955).  
 JunL 61 B. Jung and J. Svedberg, *Arkiv Fysik* 19, 429 (1961).  
 JunB 61a B. Jung and J. Svedberg, *Arkiv Fysik* 19, 447 (1961).  
 KarrM 63 Karras, Andersson, and Nurmia, *Arkiv Fysik* 23, 57 (1963).  
 KniJD 55 J. D. Knight and E. W. Baker, *Phys. Rev.* 100, 1334 (1955).  
 KriR 40b R. S. Krishnan and E. A. Nahum, *Proc. Cambridge Phil. Soc.* 36, 490 (1940).  
 KriR 41a R. S. Krishnan, *Proc. Cambridge Phil. Soc.* 37, 186 (1941).  
 LyoW 51 W. S. Lyon, *Phys. Rev.* 82, 276 (1951).  
 MalvT 58 T. V. Malysheva and I. P. Alimarin, *Soviet Phys. JETP* 3, 772 (1959).  
 MauW 42 W. Maurer and W. Ramm, *Z Physik* 119, 602 (1942).  
 MerL 61a E. Merz, *Z. Naturforschung* 16a, 1246 (1961).  
 McMilE 37 McMillan, Kamen, and Ruben, *Phys. Rev.* 52, 375 (1937).  
 NierA 50a A. O. Nier, *Phys. Rev.* 79, 450 (1950).

PofN	60	Poffé et al., J. Phys. Radium <u>21</u> , 343 (1960).
PoolM	37	Pool, Cork, and Thornton, Phys. Rev. <u>52</u> , 239 (1937).
RasJ	53	Rasmussen, Thompson, and Ghiorso, Phys. Rev. <u>89</u> , 33 (1953).
SerL	47b	Seren, Friedlander, and Turkel, Phys. Rev. <u>72</u> , 888 (1947).
SherrR	41	Sherr, Bainbridge, and Anderson, Phys. Rev. <u>60</u> , 473 (1941).
Slah	49a	H. Slätis and K. Siegbahn, Phys. Rev. <u>75</u> , 318 (1949).
SmeF	65	Smend, Schmidt-Ott and Flammersfeld, Z. Physik <u>185</u> , 426 (1965).
SmiW	55	W. G. Smith and J. M. Hollander, Phys. Rev. <u>98</u> , 1258 (1955).
ThomS	49	Thompson et al., Phys. Rev. <u>76</u> , 1406 (1949).
TilR	63a	R. S. Tilbury and L. Yaffe, Can. J. Chem. <u>41</u> , 2634 (1963).
VinA	55a	Vinogradov et al., Conf. on the Peaceful Uses of Atomic Energy, Chem. Sci. p. 132, 1955.
WieM	45a	M. L. Wiedenbeck, Phys. Rev. <u>68</u> , 1 (1945).
WuC	41	C. S. Wu and G. Friedlander, Phys. Rev. <u>60</u> , 747 (1941).
Wilsh	51	H. H. Wilson and S. C. Curran, Phil Mag. <u>42</u> , 762 (1951).
WriH	57	Wright et al., Nucl. Sci. Eng. <u>2</u> , 427 (1957).

Table II. Decay schemes of the more important mercury isotopes.

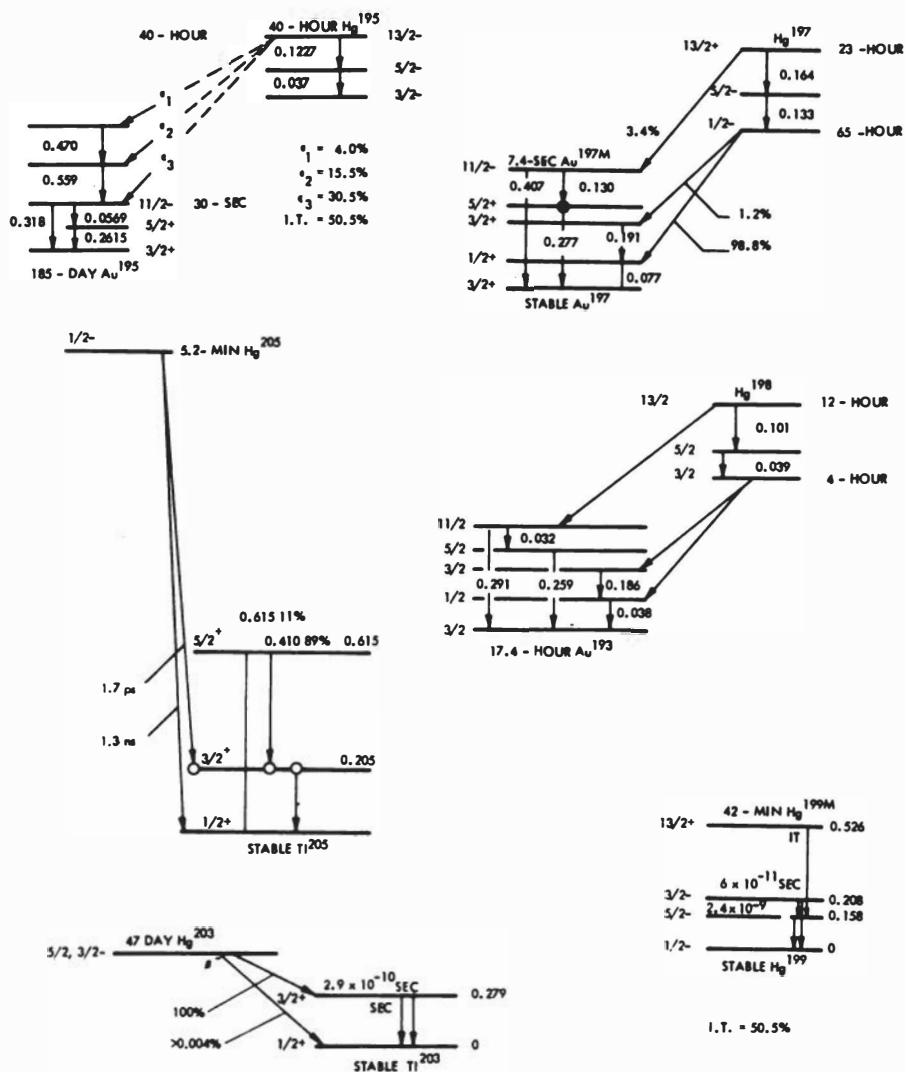

													<b>82</b>			
													<b>81</b>			
													<b>80</b>			
Hg 200 <sup>59</sup>	Hg 179 <sup>35s</sup>	Hg 180 <sup>6s</sup>	Hg 181 <sup>3.6s</sup>	Hg 182 <sup>10s</sup>	Hg 183 <sup>9s</sup>	Hg 184 <sup>32s</sup>	Hg 185 <sup>52s</sup>	Hg 186 <sup>14m</sup>	Hg 187 <sup>3m</sup>	Hg 188 <sup>37m</sup>	Hg 189 <sup>8.7m</sup>	Hg 190 <sup>20m</sup>	Hg 191 <sup>56m</sup>	Hg 192 <sup>5h</sup>	Pb 194 <sup>11m</sup>	
Au 177 <sup>1.3s</sup>	Au 178 <sup>3s</sup>	Au 179 <sup>75s</sup>		Au 181 <sup>11s</sup>		Au 183 <sup>49s</sup>	Au 184 <sup>10m</sup>	Au 185 <sup>4.3m</sup>	Au 186 <sup>12m</sup>	Au 187 <sup>2.9m</sup>	Au 188 <sup>8m</sup>	Au 189 <sup>4.6m</sup>	Au 190 <sup>42m</sup>	Au 191 <sup>32h</sup>		
Pt 176 <sup>2.57s</sup>	Pt 177 <sup>8.57s</sup>	Pt 178 <sup>21s</sup>	Pt 179 <sup>33s</sup>	Pt 180 <sup>52s</sup>	Pt 181 <sup>51s</sup>	Pt 182 <sup>2.9m</sup>	Pt 183 <sup>7m</sup>	Pt 184 <sup>10m</sup>	Pt 185 <sup>11h</sup>	Pt 186 <sup>2.3h</sup>	Pt 187 <sup>2.5h</sup>	Pt 188 <sup>10.2d</sup>	Pt 189 <sup>11h</sup>	Pt 190 <sup>100d</sup>		

**98                      100                      102                      104                      106                      108                      110                      112**

Pb 195 <sup>17m</sup>	Pb 196 <sup>37m</sup>	<sup>203</sup> Pb 97 <sup>7d</sup>	Pb 198 <sup>2.4h</sup>	<sup>209</sup> Pb 99 <sup>1.5h</sup>	Pb 200 <sup>21h</sup>	<sup>210</sup> Pb 201 <sup>6.5h</sup>	<sup>210</sup> Pb 202 <sup>3.8d</sup>	<sup>210</sup> Pb 203 <sup>6.2h</sup>	<sup>210</sup> Pb 204 <sup>1.4h</sup>	<sup>210</sup> Pb 205 <sup>3.4d</sup>	Pb 206 <sup>12.8y</sup>	<sup>210</sup> Pb 207 <sup>22.6d</sup>	Pb 208 <sup>52.3y</sup>
Tl 194 <sup>32.8m</sup>	<sup>205</sup> Tl 195 <sup>34m</sup>	<sup>205</sup> Tl 196 <sup>1.41h</sup>	<sup>205</sup> Tl 197 <sup>1.8h</sup>	<sup>205</sup> Tl 198 <sup>0.54s</sup>	<sup>205</sup> Tl 199 <sup>2.83h</sup>	<sup>205</sup> Tl 200 <sup>187h</sup>	<sup>205</sup> Tl 201 <sup>5h</sup>	<sup>205</sup> Tl 202 <sup>28.7m</sup>	<sup>205</sup> Tl 203 <sup>7.4h</sup>	<sup>205</sup> Tl 204 <sup>34m</sup>	<sup>205</sup> Tl 205 <sup>1.9m</sup>	<sup>205</sup> Tl 206 <sup>17.3d</sup>	<sup>205</sup> Tl 207 <sup>4.77h</sup>
<sup>201</sup> Hg 193 <sup>11h</sup>	<sup>201</sup> Hg 194 <sup>4h</sup>	<sup>201</sup> Hg 195 <sup>0.46s</sup>	<sup>201</sup> Hg 196 <sup>0.146s</sup>	<sup>201</sup> Hg 197 <sup>23.8h</sup>	<sup>201</sup> Hg 198 <sup>10.02d</sup>	<sup>201</sup> Hg 199 <sup>43m</sup>	<sup>201</sup> Hg 200 <sup>1.37d</sup>	<sup>201</sup> Hg 201 <sup>94m</sup>	<sup>201</sup> Hg 202 <sup>94m</sup>	<sup>201</sup> Hg 203 <sup>13.22d</sup>	<sup>201</sup> Hg 204 <sup>29.8d</sup>	<sup>201</sup> Hg 205 <sup>8.8y</sup>	<sup>201</sup> Hg 206 <sup>8.2m</sup>
<sup>197</sup> Au 192 <sup>4.7h</sup>	<sup>197</sup> Au 193 <sup>176h</sup>	<sup>197</sup> Au 194 <sup>39.5h</sup>	<sup>197</sup> Au 195 <sup>305s</sup>	<sup>197</sup> Au 196 <sup>184d</sup>	<sup>197</sup> Au 197 <sup>75s</sup>	<sup>197</sup> Au 198 <sup>100</sup>	<sup>197</sup> Au 199 <sup>2.696d</sup>	<sup>197</sup> Au 200 <sup>44m</sup>	<sup>197</sup> Au 201 <sup>3.06d</sup>	<sup>197</sup> Au 202 <sup>26m</sup>	<sup>197</sup> Au 203 <sup>55s</sup>	<sup>197</sup> Au 204 <sup>4s</sup>	
<sup>195</sup> Pt 191 <sup>10h</sup>	<sup>195</sup> Pt 192 <sup>0.78h</sup>	<sup>195</sup> Pt 193 <sup>4.3d</sup>	<sup>195</sup> Pt 194 <sup>32.9</sup>	<sup>195</sup> Pt 195 <sup>41d</sup>	<sup>195</sup> Pt 196 <sup>33.8h</sup>	<sup>195</sup> Pt 197 <sup>25.3</sup>	<sup>195</sup> Pt 198 <sup>7.21</sup>	<sup>195</sup> Pt 199 <sup>14.1g</sup>	<sup>195</sup> Pt 200 <sup>12h</sup>	<sup>195</sup> Pt 201 <sup>2.5m</sup>			

**114                      116                      118                      120                      122                      124                      126**

Figure 1. Section of the Chart of Nuclides around mercury. (Taken from reference 2)  
See page 201 for copyright citation.

### III. REVIEW OF FEATURES OF MERCURY CHEMISTRY OF CHIEF INTEREST TO RADIOCHEMISTS

#### 1. Metallic Mercury

Some of the more important physical properties of mercury are summarized in Table III.

Table III. Some physical properties of metallic mercury.

Atomic weight (1956 International value)	200.61
Crystal structure	rhombohedral, $a=3.005^{\circ}\text{A}$
Melting point, $^{\circ}\text{C}$ .	-38.87
Boiling point, $^{\circ}\text{C}$ ., at 760 mm Hg	356.6
Latent heat of fusion, kcal/g.-atom	0.557
Latent heat of vaporization, kcal/g.-atom at b.p.	14.2
Specific heat, cal/g.-atom, at $20^{\circ}\text{C}$ .	6.67
Heat of formation, kcal.	14.54 (vapor)
Free energy of formation, kcal.	7.59 (vapor)
Entropy, cal/degree	41.8 (vapor), 18.5 (liq.)
Density, g/cc, at $0^{\circ}\text{C}$ .	13.595
at $20^{\circ}\text{C}$ .	13.546
at $30^{\circ}\text{C}$ .	13.522
Coefficient of linear thermal expansion, per $^{\circ}\text{C}$ ., at $20^{\circ}\text{C}$ .	$3 \times 10^{-5}$
Coefficient of cubical thermal expansion over range 0 to $100^{\circ}\text{C}$ .: $(V)_t^{\circ}\text{C} = (V)_0^{\circ}\text{C}(1+at+bt^2+ct^3)$ ,	$a=1.816904 \times 10^{-4}$ $b=2.95127 \times 10^{-9}$ $c=1.1456 \times 10^{-10}$
Thermal conductivity, cal/sec/cm <sup>2</sup> / $^{\circ}\text{C}$ ./cm at $0^{\circ}\text{C}$ .	0.0248
Electrical resistivity, ohm/cm, at $20^{\circ}\text{C}$ .	$9.58 \times 10^{-5}$

The position of mercury in the electromotive series and its standard electrode potentials indicate its 'noble metal' character. The standard electrode potentials at  $25^{\circ}\text{C}$  of some mercury couples are:<sup>4,5</sup>

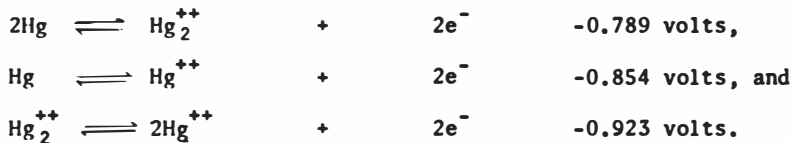

Brief mention should be made here of the use of mercury in polarography.<sup>6</sup>

Metallic mercury is not oxidized by dry air at room temperature, but, when heated, slowly forms red HgO, which in turn decomposes at about 500 °C. The metal is inert toward most gases except the halogens and sulfur vapor which combine directly with it even at room temperature. In fact, sulfur powder has been recommended as a means of rendering spilled mercury less toxic, since it coats the metal with HgS. Mercury does not react with hydrochloric or dilute sulfuric acid, but dissolves in nitric or hot concentrated sulfuric acid forming mercury (II) salts.

Metallic mercury is perceptibly volatile at room temperature which accounts for the presence of traces of mercury in many reagents and often in laboratory air. The vapor pressure of mercury in the temperature range between -20 °C and 100 °C is shown in Figure 2.<sup>3</sup> The volatility of mercury is the basis of many radiochemical separations (see Chapter VI).

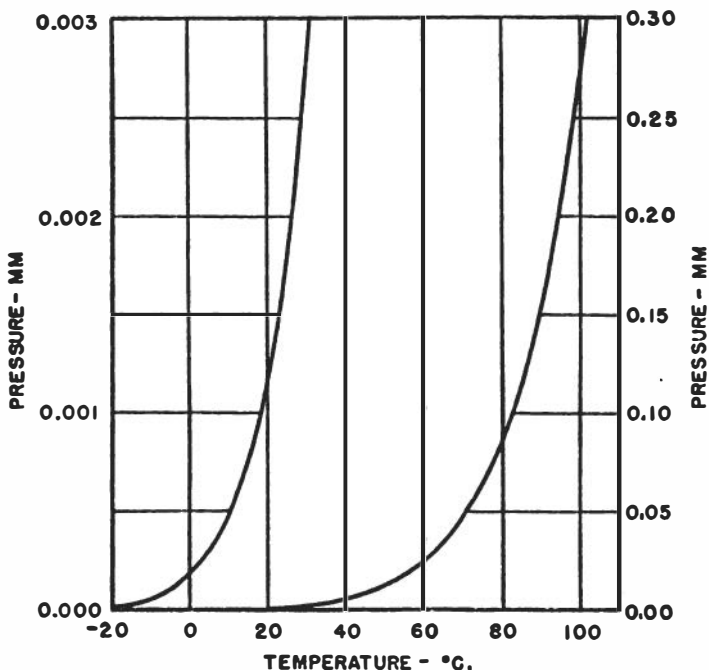

Figure 2. Vapor pressure curve of mercury (pressure in mm. of mercury).  
See page 201 for copyright citation.

An important property of metallic mercury is its ability to dissolve many metals to form amalgams some of which are intermetallic compounds and others are true solutions. The solubilities of some metals in mercury are summarized in Table IV.<sup>3</sup> Metals which amalgamate easily are not necessarily very soluble in mercury.

TABLE IV. Solubility of selected metals in mercury at 18° C (in weight percent).

Li														
.09														
Na Hg														
0.68 0.24														
K	Ca	Tl	V	Cr	Mn	Fe	Co	Ni	Cu	Zn	Ca			
0.80	0.30	$<1 \times 10^{-5}$	$<5 \times 10^{-5}$	$<4.10^{-7}$	$1.7 \times 10^{-3}$	$1.5 \times 10^{-6}$	$<1 \times 10^{-6}$	$<2 \times 10^{-6}$	$2 \times 10^{-3}$	2.15	1.3			
Rb														
1.54														
				Mo						Ag	Cd	In	Sn	Sb
				$<2 \times 10^{-5}$						0.042	4.92	27.0	0.62	$2.9 \times 10^{-5}$
Cs Ba														
4.34 0.33														
				W						Au	Ti		Pb	Bi
				$<1 \times 10^{-5}$						0.13	42.8		1.3	1.4

See page 201 for copyright citation.

The relatively high solubility of gold and platinum in mercury has been utilized to prepare high specific activity sources of mercury isotopes.<sup>7</sup> Very selective radiochemical separation procedures have been developed by making use of amalgam exchange reaction<sup>8,9</sup> which are discussed in some detail in Chapter VI.

Amalgamation has also been utilized in the pyrometallurgical extraction and purification of uranium<sup>10</sup> and plutonium<sup>11</sup> from nuclear reactor fuels.

The solubility of metallic mercury in water, earlier to be of the order of  $0.1 \times 10^{-7}$  g Hg/g, was recently confirmed in measurements by Choi and Tuck<sup>12</sup> who utilized a neutron activation method.

A survey on mercury designed to collect in a single document all the fundamental data which may be of interest to the military has been prepared by Pfennington.<sup>13</sup>

Methods for the purification of metallic mercury have been reviewed by Gordon and Wichers,<sup>3</sup> and by Soucek.<sup>14</sup>

The most important properties of metallic mercury, as far as its radiochemistry is concerned, are its volatility and its tendency to form amalgams.



## 2. Mercury Compounds

Many of the chemical properties of mercury have no parallel among its neighbors in the Periodic Table. The more important dissimilarities with other elements are the following:

a. Mercury has a very pronounced tendency to form covalent instead of ionic bonds. This tendency shows up in the dimerization of mercurous ions in solution. Unlike cuprous ions, mercurous ions exist as  $\text{Hg}^+ \cdot \text{Hg}^+$  in solution.

b. Mercury is unique among metals in its capability to form covalent Hg-C bonds. The replacement of hydrogen atoms from organic compounds by mercury, the process of 'mercuration', proceeds almost as easily as nitration or bromination. Thus, the existence of large numbers of organic mercury compounds should be no surprise. In fact, mercury is said to have an organic chemistry of its own.<sup>15</sup> The relative inertness of the Hg-C bond with respect to hydrolysis and oxidation has its reason in the low affinity of mercury for oxygen and its slight tendency to form coordination compounds.

On the other hand, mercury exhibits many similarities with its neighboring elements in the Periodic System. A resemblance with copper is the formation of series of compounds in which mercury, like copper, has the oxidation states +1 and +2. Similarities with silver are the light sensitivity and insolubility in water of mercurous chloride, bromide and iodide. In analogy to aurous ion, mercurous ions undergo disproportionation in solution according to



The precipitation of oxysalts when Hg(II) solutions are diluted with water is a parallel to bismuth chemistry.

### a. Mercury (I) Compounds

The chemistry of monovalent mercury does not show the many 'anomalies' of divalent mercury; the latter is determined by the tendency of Hg(II) to

form bonds of predominantly covalent character. To a large extent the chemistry of  $\text{Hg}_2^{+2}$  is ruled by the disproportionation equilibrium

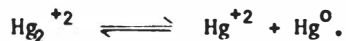

The degree of disproportionation depends upon the solubility or the amount of dissociation of the Hg(II) compound formed. The black 'Hg<sub>2</sub>O' of the early textbooks is a mixture of finely divided Hg and HgO formed by the disproportionation reaction

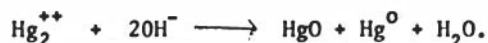

The reaction is quantitative because HgO is insoluble. Disproportionation also occurs when a Hg(I) solution is made alkaline with ammonia



or when Hg(I) ions react with anions, such as  $\text{HS}^-$  or  $\text{I}^-$ , which form bonds with Hg(II) of appreciably covalent character. In solution, the mercurous salts exhibit normal dissociation which leads to slight hydrolysis. The abnormally low dissociation found in solutions of many mercuric compounds does not occur in Hg(I) solutions. Oxidation of mercurous salts to the Hg(I) state can be accomplished by heating with permanganate,  $\text{Ce}^{+4}$ , nitric acid, and any of the free halogens.

From a radiochemist's point of view, the most important Hg(I) compound is  $\text{Hg}_2\text{Cl}_2$ . The precipitation of  $\text{Hg}_2\text{Cl}_2$  is a means of separating  $\text{Hg}_2^{++}$  from most other metal ions except  $\text{Pb}^{++}$ ,  $\text{Tl}^+$ , and  $\text{Ag}^+$ . Furthermore,  $\text{Hg}_2\text{Cl}_2$  is a weighing form of Hg(I).

#### b. Mercury (II) Compounds

Mercury (II) salts, in general, have higher solubility in water than their Hg(I) counterparts. The degree of ionization of Hg(II) salts in water

depends greatly on the nature of their anions. Mercury (II) salts of oxyacids such as sulfate, perchlorate, and nitrate are strong electrolytes, whereas, the halides, thiocyanate, and particularly cyanide are very weak electrolytes. The difference in the covalent bond character between Hg(II) and  $\text{Cl}^-$  and  $\text{NO}_3^-$  ions shows up in the pH values<sup>16</sup> at which HgO precipitates: 7.3 in HgCl<sub>2</sub> solutions, and 2 in Hg(NO<sub>3</sub>)<sub>2</sub> solutions.

Ammonia reacts with HgO or mercuric salts to form three types of compounds.

1. Hg(NH<sub>3</sub>)<sub>2</sub> Cl<sub>2</sub> 'fusible white precipitate',.
2. H<sub>2</sub>N-Hg-Cl 'infusible white precipitate', and
3. (HO-Hg)<sub>2</sub>NH<sub>2</sub>OH 'Millon's base'.

The mercuric salts of oxyacids form salts of 'Millon's base' such as



This tendency to form preferably amido compounds, containing covalent Hg-N bonds is found to a much smaller degree in gold. Most metals react with ammonia and its derivatives to form amines or amino compounds.

In the dry state mercury compounds are easily reduced to the metal by heating the compound with finely divided metal such as iron powder or CaO. Sulfide containing mercury compounds have been reduced by heating that compound with lead chromate.

Reduction in slightly alkaline solution has been accomplished with hydrazine, hydroxylamine, formaldehyde, formate ion, hydrogen peroxide, arsenite ion and hypophosphorous acid. Reducing agents for Hg(II) in slightly acid solution are metals, such as Zn or Cu, stannous chloride, and methanolamine.

In the Noyes and Bray scheme of qualitative analysis,<sup>17</sup> mercury (II) appears in the Gold Group which is reproduced as Appendix I of Procedure 8. The Gold Group consists of elements which can be completely precipitated by boiling with formic acid, namely mercury, gold, platinum, and palladium.

In the classical scheme of qualitative analysis,<sup>18</sup> mercury (I) appears in the Hydrochloric Acid Group (silver, mercury (I), lead (II), and thallium (I)) where it is precipitated as calomel,  $\text{Hg}_2\text{Cl}_2$ . The presence of calomel in the mixed chloride precipitate is confirmed by the black coloration (finely divided metallic mercury) produced with aqueous ammonia.

Mercury (II) appears in the Copper Group and is precipitated as the sulfide from 2N hydrochloric acid solution. It is distinguished from all other sulfides precipitated in this group in that it is insoluble in ammonium polysulfide and in dilute nitric acid.

### 3. Complex Mercury Compounds

Divalent mercury complexes are quite numerous. The more important are those in which the metal is attached to carbon (as in the cyanides), nitrogen, sulfur, or the halogens. The coordination number of mercury in these complexes is four.

The halide complexes are of the type  $\text{M}_2(\text{Hg}(\text{Hal})_4)$ ;  $\text{M}_2$  can be, for example, cadmium, potassium or zinc. The halide part can be bromide, chloride, iodide, cyanide, etc. These complexes are more stable than the corresponding ones of cadmium. Diammine halides of the form  $\text{Hg}(\text{NH}_3)_2(\text{Hal})_2$  are insoluble and do not redissolve in excess ammonia. Mercury has stronger affinity for sulfur than for oxygen, therefore, complexes with Hg-S bonds are more numerous.  $\text{HgS}$  dissolves in concentrated solutions of alkaline sulfides and coordination compounds of the form  $\text{M}_2(\text{HgS}_2)$  crystallize with large numbers of water of crystallization.

Most complexes formed by  $\text{Hg}(\text{II})$  do not have  $\text{Hg}(\text{I})$  analogs. In fact, no complexes of the mercurous ion with ammonia, ethyl sulfide, or halogens have been prepared. These complexes are unstable with respect to disproportionation into the corresponding mercuric complex and metallic mercury. However, mercurous ion forms stable soluble complexes with pyrophosphate, oxalate, succinate, and tripolyphosphate.<sup>19</sup>

#### 4. Toxicity

Although used internally in small doses as medication, metallic mercury and its compounds are very toxic. Inhalation of mercury vapor, even in small amounts, is hazardous since the inhaled vapor accumulates in the body. Metallic mercury can be absorbed through the unbroken skin. Symptoms of mercury poisoning are salivation, ulceration of the mucuous membranes of the mouth, diarrhea, tremors, nausea, nervousness, headaches, anemia, a peculiar reddening of the gums, and loosening of the teeth. Early symptoms are groundless fears, apprehensions and mental lassitude.

Acute mercurialism results in damage to the kidneys and is often fatal; chronic mercury poisoning damages the nervous system, often permanently. Treatment and Antidotes:<sup>20</sup> If acute mercury poisoning is suspected, call a physician at once. Give patient a quart of milk containing three raw eggs and an emetic (soap water). The stomach should again be washed out with a pint of water, containing three tablespoons of charcoal and 20 g of magnesium sulfate.

An an antidote give a glass of freshly prepared 5 to 10 percent solution of sodium formaldehyde sulfoxylate or a solution of 1 g of sodium hypophosphite and 5 ml of 5 percent hydrogen peroxide in 10 ml of water per 100 mg of  $\text{HgCl}_2$  swallowed.

A bibliography on mercury toxicity compiled by Voress and Smelcer,<sup>21</sup> lists 1676 references. In a monograph on the control of mercury in the laboratory, safe handling procedures, monitoring, and decontamination methods are reviewed.<sup>22</sup>

It has been established<sup>23</sup> that laboratory air almost always contains appreciable quantities of mercury vapor, a fact that should be taken into consideration when attempting to measure low concentration of the element.

## 5. Insoluble Mercury Compounds

Water insoluble mercury compounds are of interest to the radiochemist provided they are of defined stoichiometry, have a defined range of thermal stability, are relatively inert toward oxidation and hydrolysis, and are reasonably soluble in organic solvents.

### a. Inorganic Compounds

Typical inorganic weighing forms of mercury, useful for standardizing carrier solutions and for preparing solid counting samples, and the limits of their thermal stability are summarized in Table V.

### b. Organic Compounds

A number of organic compounds form water-insoluble chelates with divalent mercury which have desirable properties such as well-defined composition, solubility in organic solvents, and stability at elevated temperatures. The most often used mercury reagents, taken from Welcher,<sup>24</sup> are summarized in Table VI.

The solubility of many of the organo-mercury compounds in organic solvents lends itself to devise specific solvent extraction separations. The selectivity of such extractions often can be increased by masking agents.

Summaries of thermodynamic stability constants of organo-mercury complexes have been prepared by Coetzee<sup>25</sup> and Fultz.<sup>26</sup>

## 6. Coprecipitation Characteristics of Mercury Traces

To date little information on the coprecipitation behavior of mercury has appeared in the literature. Wahl and Bonner<sup>27</sup> mention that mercurous tracer is carried quantitatively by silver chloride. This observation seems to suggest that mercurous tracer might also be carried by the insoluble chlorides of the Hydrogen Chloride Group of the classical scheme of qualitative analysis,<sup>15</sup> i.e., by thallos chloride, lead chloride, and silver chloride.

TABLE V. Thermal stability of inorganic weighing forms of mercury.

Precipitant	Weighing Form	Temperature Limits, °C.
As mercury metal		
Electrolysis	Hg	<70
Hypophosphorous acid	Hg	<71
Hydrazine	Hg	<55
Zinc	Hg	<72
As mercury (I) compounds		
Hydrochloric acid	Hg <sub>2</sub> Cl <sub>2</sub>	<130
Potassium iodate	Hg <sub>2</sub> (IO <sub>3</sub> ) <sub>2</sub>	<175
Potassium chromate	Hg <sub>2</sub> CrO <sub>4</sub>	52-256
Potassium tungstate	WO <sub>3</sub>	>880
Oxalic acid	Hg <sub>2</sub> C <sub>2</sub> O <sub>4</sub> *	<100
As mercury (II) compounds		
Potassium iodide	HgI <sub>2</sub>	45-88
Ammonium sulfide	HgS	<109
Sodium thiosulfate	HgS	75-220
Disodium arsenate	Hg <sub>3</sub> (AsO <sub>4</sub> ) <sub>2</sub>	45-418
Ammonium dichromate + pyridine	[Hg(pyr) <sub>2</sub> ]Cr <sub>2</sub> O <sub>7</sub>	56-66
Reinecke's salt	Hg[Cr(SCN) <sub>4</sub> (NH <sub>3</sub> ) <sub>2</sub> ] <sub>2</sub>	77-158
Zinc ion + thiocyanate	Zn[Hg(SCN) <sub>4</sub> ]	<270
Cobalt(II) ion + thiocyanate	Co[Hg(SCN) <sub>4</sub> ]	50-200
Cadmium ion + ammonia + iodide	[Cd(NH <sub>3</sub> ) <sub>4</sub> ][HgI <sub>3</sub> ] <sub>2</sub>	<69
Copper(II) ion + ethylenediamine + iodide	[Cu(en) <sub>2</sub> ][HgI <sub>4</sub> ]	ca. 20
Copper(II) ion + propylenediamine + iodide	[Cu(pn) <sub>2</sub> ][HgI <sub>4</sub> ]	<157
Copper(II) biguanide ion + iodide	[Cu(C <sub>2</sub> N <sub>5</sub> H <sub>7</sub> ) <sub>2</sub> ][HgI <sub>4</sub> ]	60-175
Sodium anthranilate	Hg(C <sub>7</sub> H <sub>6</sub> O <sub>2</sub> N) <sub>2</sub>	<113
Thioanilide	Hg(C <sub>12</sub> H <sub>10</sub> ONS) <sub>2</sub>	90-169
Dithiane + chloride	HgCl <sub>2</sub> ·C <sub>4</sub> H <sub>8</sub> S <sub>2</sub>	<97

\*Explodes violently at 104 °C.

Among sulfide collectors, CuS,<sup>28-30</sup> CdS,<sup>31, 32</sup> and As<sub>2</sub>S<sub>5</sub><sup>31, 32</sup> have been found most efficient in concentrating traces of mercury presumably by forming mixed sulfides.

The property of cadmium sulfide to collect mercuric, cupric, and silver ions has been utilized to remove these ions from dilute (0.001 - 0.004 N) nitric acid solutions.<sup>33</sup> When dilute (e.g. traces) or concentrated

Table VI. Organic reagents for mercury.

Compound	Structure	Remarks
Anisaldehyde		Precipitates Hg(I) and Hg(II) at pH 5.89. Both precipitates are light yellow, insoluble in alcohol, acids and dilute Ni <sub>4</sub> OH.
Anthranilic acid		Also precipitates metals which form ammine complexes such as Cu, Zn, Ni, Co, Cd, Ag, Mn, Pb, and Fe. Drying temperature of Hg(anthr) <sub>2</sub> 100-160 °C.
Benzaldehyde		Hg(II) pH 5.89, light yellow ppt, soluble in alcohol and acetone.
p-Dimethylamino Benzalrhodanine		Precipitates Au, Hg, and Ag.
Diphenylcarbazide		For determination of As, Cl, Cr, Fe, Pb, Hg, Mo, P, So <sub>4</sub> , and V. Chelates are extractable in CCl <sub>4</sub> . Solution to be analyzed must not be more than 0.003 N in electrolyte, must not contain Cl <sup>-</sup> , and should have a pH of 3.5 - 4.5.
Diphenylcarbazone		The K-salt of diphenylcarbazone forms blue insoluble salts with Zn, Pb, Cu, Hg, Cr, Fe, Ni, and Co.
a, a' Dipyridyl, also 2, 2' Dipyridyl		Ppts anions such as HgI <sub>4</sub> , Hg(SCN) <sub>6</sub> , CdI <sub>4</sub> , Zn(CN) <sub>4</sub> , Ni(CN) <sub>4</sub> , etc.
2 - Fluorenyl - Cupferron		White ppt with Hg(I) in slightly acidic solution. White ppt with Hg(II) in neutral solution, soluble in CHCl <sub>3</sub> , reprecipitated by addition of ligroin.
2 - (0-hydroxyphenyl benzimidazole)		Fe(III) main interference.
Phenylboric acid	C <sub>6</sub> H <sub>5</sub> -B(OH) <sub>2</sub>	Ppt dried at 70 °C weighed in vacuo.
Resorcyaldehyde		Yellow ppt at pH 3.4-7, soluble in hot alcohol.
Thioacetamide		Max. Normality of Acid
in acid solution		HC <sub>1</sub> H <sub>2</sub> SO <sub>4</sub> HNO <sub>3</sub> 0.2      0.5      0.5
in basic or neutral solution		HgS ppt in cold, not affected by EDTA.
Pyridine		Interferences by CrO <sub>4</sub> , Au(III), IO <sub>3</sub> , V(V), SeO <sub>3</sub> , SiO <sub>3</sub> . Hg salts also react with pyridine and K <sub>2</sub> Cr <sub>2</sub> O <sub>7</sub> to form an orange, slightly soluble salt. HgCl <sub>2</sub> and pyridine form a ppt, HgCl <sub>2</sub> Py, which dissolves in excess of pyridine.
Thionalide, α-mercapto N-2-naphthyl acetamide		Precipitates elements of the H <sub>2</sub> S group. Unlike the sulfides, the thionates have definite composition and can be dried easily. There is also no coprecipitation or postprecipitation. From a solution 0.1-0.5 N in INO <sub>3</sub> , the following elements besides Hg are precipitated: Cu, Bi, As, Sb, Sn, Au, Ag, Pd, Pt.



(e.g.  $-1 \text{ M}$ ) solutions of silver, mercuric and copper nitrates with and without supporting electrolyte ( $\text{NaNO}_3$ ,  $\text{HNO}_3$ ) are passed through beds of 80-170 mesh  $\text{CdS}$ , 3 millimeters wide and about 20 millimeters long, quantitative removal of the heavy metal ions was observed. The adsorption-displacement reaction



proceeds very rapidly. Quantitative retention of mercury, silver, and copper was observed with 20-30 millimeter long columns, at flow rates of up to 50 ml/minute.

The hydroxides of aluminum, iron, and manganese (IV), and zinc oxide do not carry mercury traces.<sup>30</sup>

Coprecipitation of zinc, cadmium, and mercury with anthranilic acid at pH values too low for the precipitation of the corresponding anthranilates was investigated by Korenman and Baryshnikova.<sup>34</sup> Various amounts of sodium anthranilate solution were added to solutions containing  $\text{Zn}^{65}$ ,  $\text{Cd}^{115}$ , and  $\text{Hg}^{203}$  at different pH values, and the amount of metal precipitated was determined as a function of the amount of anthranilic acid and pH. At pH 0.65, 100 mg anthranilic acid will coprecipitate 25  $\mu\text{g}$  of cadmium almost quantitatively. Under similar conditions the amount of coprecipitation for these elements decreases in the order of increasing atomic number.

Other organic collectors for mercury traces are copper oxinate<sup>35-37</sup> and the methylviolet-iodide system.<sup>38</sup>

## 7. Isotopic Exchange Characteristics

The success of a radiochemical separation depends critically upon the completeness of the isotopic exchange between carrier and tracer. Occasionally difficulties in achieving complete exchange arise where carrier and tracer have different oxidation states.

In solution, mercury exchanges rapidly, no matter what its oxidation state<sup>39,40</sup> or the solvent. The pertinent results of studies on homogeneous

exchange reactions in water, as compiled by Wahl and Bonner,<sup>27</sup> are summarized in Table VII.

Table VII. Homogeneous exchange reactions of mercury.

Tracer	Reactants	Temp. (°C)	Other Conditions	Separation Method	Half-Time of Exchange
48-day Hg <sup>203</sup>	Hg <sup>++</sup> —Hg <sub>2</sub> <sup>++</sup>	Rm.	10 <sup>-5</sup> f Hg(ClO <sub>4</sub> ) <sub>2</sub> , 10 <sup>-3</sup> f Hg <sub>2</sub> (ClO <sub>4</sub> ) <sub>2</sub> , 3 f NaClO <sub>4</sub> , 0.5 f HClO <sub>4</sub>	Hg <sub>2</sub> Cl <sub>2</sub> (s)	<15 s
	Hg <sup>++</sup> —Hg <sub>2</sub> <sup>++</sup>	"	0.0044 f Hg(ClO <sub>4</sub> ) <sub>2</sub> , 0.0069 f Hg <sub>2</sub> (ClO <sub>4</sub> ) <sub>2</sub> , 0.1 f HClO <sub>4</sub>	Hg <sub>2</sub> CrO <sub>4</sub> (s)	<15 s
	"	"	0.0093 f Hg(ClO <sub>4</sub> ) <sub>2</sub> , 0.0059 f Hg <sub>2</sub> (ClO <sub>4</sub> ) <sub>2</sub> , 0.16 f HClO <sub>4</sub>	Hg <sub>2</sub> SO <sub>4</sub> (s)	<15 s
43-min Hg <sup>199m</sup>	Hg <sup>++</sup> —Hg <sub>2</sub> <sup>++</sup>	"	...	...	Short

See page 201 for copyright citation.

In studies on the germicidal action of phenylmercuric salts the exchange of mercury between phenylmercury salts and mercuric salts<sup>41</sup> has been investigated using Hg<sup>203</sup>. The reaction

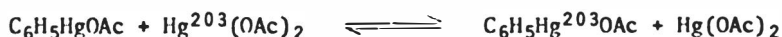

reached equilibrium in about one minute and was found to be independent of the solvents used: glacial acetic acid, 50 percent ethanol, water, and benzene. However, an anion effect was noticed. The half time for the exchange reaction

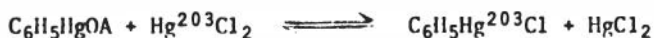

was found to require about 37 minutes at room temperature in dry benzene. The presence of HCl increased the rate of exchange to less than one minute.

Rapid exchange between diphenyl mercury and parachlorodiphenyl mercury labeled with Hg<sup>203</sup>, was observed at 60 °C in pyridine solution.<sup>42</sup>

The isotopic exchange of mercury between HgBr<sub>2</sub>, labeled with Hg<sup>203</sup>, and 6H<sub>3</sub>HgBr in the ethanol solvent system proceeds rapidly as a biomolecular reaction.<sup>43</sup>

In heterogeneous system the exchange of mercury was found to be slow.<sup>39,44</sup> Some representative data<sup>27</sup> are presented in Table VIII.

TABLE VIII. Heterogeneous exchange reactions of mercury.

Tracer	Reactants	Temp. (°C)	Other Conditions	Time	Extent Of Exchange
48-day Hg <sup>203</sup>	Hg*(I)—Hg*(I)	18	0.05 f Hg <sub>2</sub> (ClO <sub>4</sub> ) <sub>2</sub> or 0.05f Hg <sub>2</sub> (NO <sub>3</sub> ) <sub>2</sub> , pH 1.5—1.6	32 m	50%
"	Hg*(I)—Hg*(II)	Rm.	0.1 f Hg(NO <sub>3</sub> ) <sub>2</sub> , pH 1.7	-30 m	50%
"	Hg <sub>2</sub> Cl <sub>2</sub> (s)—Hg(II)	"	Fresh Hg <sub>2</sub> Cl <sub>2</sub> (s)	2.5 m	30%
"	"	"	Hg <sub>2</sub> Cl <sub>2</sub> (s) aged 7.5 m	"	10%
"	Hg <sub>2</sub> CrO <sub>4</sub> (s)—Hg(II)	"	Fresh Hg <sub>2</sub> CrO <sub>4</sub> (s)	2 m	>95%
"	"	"	Hg <sub>2</sub> CrO <sub>4</sub> (s) aged 6 m	"	<5%

See page 201 for copyright citation.

In a study to measure the effect of halide ions on the heterogeneous exchange reaction Hg (metal vapor in air)  $\rightleftharpoons$  Hg<sup>203</sup> (in solution), the rate of exchange was found to be rapid but to depend also on the concentration of mercuric ions and the type and concentration of the halide ions present in solution.<sup>45</sup>

When mercury vapor is passed through a solution of labeled mercuric acetate, and containing some KCl, the escaping mercury vapor was found to be labeled to the same specific activity as the dissolved mercuric acetate.<sup>46</sup> The emerging (labeled) mercury vapor can then be measured by gamma counting after collection on a solid absorbent and thus provides an estimate of the mercury concentration in the air which had been passed through the solution containing labeled mercuric acetate. This observation was the basis for a radiochemical method for the measurement of the concentration of mercury vapor in air.<sup>46</sup> This method is presented as Procedure 29 in Chapter VI.

Attempts to prepare radioactive mercury in high specific activity by Szilard-Chalmers reactions on phenylmercuric acetate were unsuccessful not because of exchange difficulties but rather because of the high decomposition rate of mercury compounds during irradiation.<sup>47</sup>

A systematic study of the isotopic exchange between a drop of mercury and mercury ions in aqueous and non-aqueous solution<sup>48</sup> revealed that the following reactions can occur:

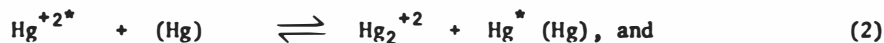

where \* represents radioactive mercury, and (Hg) the metallic mercury phase. Superimposed on above exchange reaction is the equilibrium



which has no direct effect on the isotopic exchange but which depends on the pH of the solution. The isotopic exchange between metallic mercury and mercury ions proceeds predominantly via reactions (1) and (2), is relatively insensitive to the pH of the solution and is virtually quantitative within a few minutes of contact and agitation regardless whether the reaction is carried out in an aqueous or non-aqueous solution. Ions which have higher redox potentials than mercury such as gold, platinum, palladium, silver, indium, osmium, tellurium, and selenium interfere in that these elements deposit spontaneously on metallic mercury. The rate of the mercury metal-mercury ion exchange reaction can be increased by mechanical or ultrasonic agitation.<sup>49</sup>

The rapid exchange rate between mercury metal and mercury ions has been utilized to remove traces of radioactive mercury ions from dilute (1N) HCl and HNO<sub>3</sub> solutions.<sup>50</sup>

## 8. Amalgam Exchange

Recently a very selective radiochemical separation procedure has been developed<sup>8</sup> by utilizing the occurrence of a rapid isotopic exchange between

metal ions in solution and a dilute amalgam of the same metal. The separation proceeds in two isotopic exchange steps. In the first step, the radioactive metal ions,  $M^*$ , selectively exchange with inactive metal,  $M$ , in the amalgam:



To shift above equilibrium toward the right, the concentration of  $M$  in the amalgam phase must be made greater than the concentration of  $M^*$  in the aqueous phase. After a suitable contact time, usually of the order of several minutes, the amalgam is separated from the aqueous phase. To back-exchange the  $M^*$  ions into an aqueous phase, the amalgam is agitated with a solution whose concentration in  $M$  ions is greater than the concentration of  $M^*$  in the amalgam.

The reason for the excellent selectivity achieved in amalgam exchange separations is that other contaminating elements in solution will not exchange with the desired element in the amalgam. Since there is practically no mutual interaction between aqueous and amalgam phases, the degree of separation generally is very high.

The feasibility of using amalgam exchange as a means of separating cadmium, thallium, zinc, lead, bismuth, strontium, indium, and tin has been demonstrated and detailed separation procedures for indium,<sup>51</sup> cadmium,<sup>52,53</sup> zinc,<sup>54</sup> strontium,<sup>55</sup> and bismuth<sup>56</sup> have been published.

Elements which exhibit several oxidation states in aqueous solution, such as thallium, often do not exchange upon prolonged agitation. However, when stirred for a few minutes, the exchange usually is high.

Mercury itself has been used analytically as a reducing agent for noble metals.<sup>57</sup> The reducing action of metallic mercury and the ease with which noble metal amalgams are formed may well be the reason for the observed interference of noble metal ions such as  $\text{Au}^{+++}$ ,  $\text{Pt}^{++}$ ,  $\text{Pd}^{++}$ , and  $\text{Ag}^+$  with the amalgam exchange. It has been suggested<sup>51</sup> to remove noble metal ions, including  $\text{Hg}^{++}$ , from the solution first by agitating it first with pure

mercury and then proceed to separate the desired nuclide with the appropriate amalgam.

Some amalgams are reducing agents of almost the reducing power of the pure metal of which the amalgam is made. The behavior may cause contamination of the aqueous phase. A possible solution to this problem is the use of a selective scavenging step, similar to the removal of noble metal ions from solution mentioned above, except that one would use an amalgam prepared with a metal of a somewhat higher reduction potential than the desired metal.

The rates of exchange of ions of thallium, cadmium, lead, zinc, copper, bismuth, sodium, potassium, and cesium with their respective amalgams have been measured by Randles and Somerton.<sup>58</sup> The preparation of various amalgams is described in "Inorganic Synthesis" by Booth, Audrieth, and Boiler.<sup>59</sup>

#### 9. Solvent Extraction

In the following, the term 'solvent extraction' means the preferential partition of inorganic ions across a liquid-liquid phase boundary into a water-immiscible organic solvent. Ions in aqueous solution exist as aquo complexes where all coordination positions are taken up by water molecules. The likelihood for an aquo complex to pass through the liquid-liquid interface and mix with the organic phase is very small because of the highly polar character of the molecule. To make an ion cross the boundary between aqueous and organic phase, all or most of its water molecules must be removed and replaced by other firmly coordinated ions or groups which reduce the polar character of the molecule. The replacement of several water molecules by multidentate ligands and the inherent strength of subsequent ring closure results in neutral molecules that dissolve and hence extract easily into organic solvents. It follows from the requirement of electrical neutrality that an ion can cross a liquid-liquid phase boundary provided it is 'locked up' in an undissociated neutral molecule, where valence and coordination requirements are satisfied by a chelating agent. Such a system is called a Chelate Extraction System.

Ions can pass also the phase boundary provided they take with them an equal amount of charges of the opposite polarity. These ions pass from the aqueous into the organic phase in association with other counter ions. This type of system is known as the Ion Association Extraction System. It should be kept in mind that there is a smooth transition between chelates and ion association (coordination) compounds. For details on the experimental aspects of solvent extraction the reader is referred to the excellent work by Morrison and Freiser.<sup>60</sup>

#### a. Chelate Extraction Systems

Many organic precipitants used in inorganic analysis are suitable for solvent extraction. The metal ions to be extracted are fully chelated, i.e., completely surrounded by bulky organic molecules. Since there is generally no reaction between chelate and solvent molecules the nature of the organic solvent is not very critical and often even hydrocarbons are used. Quite often the solubility of the metal chelates is low and thus are not amenable to bulk extractions. However, the sensitivity is usually very high because of the effects of ring closure and entropy differences.

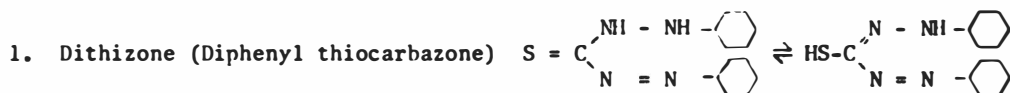

Dithizone is an important organic reagent because of its versatility and the extent to which it has been studied. It is a weak monobasic acid, having a dissociation constant  $\sim 10^{-5}$ .<sup>61</sup> The partition coefficient of dithizone between  $\text{CCl}_4$  and  $\text{H}_2\text{O}$  is  $\sim 10^4$ . The  $\text{CCl}_4$  solution is intense green in color. On exposure to daylight, the  $\text{CCl}_4$  solution of the reagent developed a dark greyish-green color and becomes bluish-purple in sunlight. This photochemical effect is reversed in the dark and the original color is restored. Acetic acid inhibits this color change.<sup>62</sup> The metal chelates, strongly colored red, orange, brown, or violet, make it well suited for the absorptiometric determination of microgram quantities of these metals. Dithizone reacts with  $\text{Hg}(\text{II})$ ,<sup>63</sup> silver, lead and bismuth,<sup>64</sup>

gold, indium, zinc, thallium (I) and (III), iron, platinum (II), palladium and copper.

In order to obtain higher selectivity in dithizone reactions which cannot be achieved with pH regulation alone, extensive use of masking agents such as cyanide, thiocyanate, thiosulfate, and EDTA has been made. Table IX shows that dithizone reacts with fewer metals in the presence of masking agents.

Table IX. Masking agents in Dithizone reactions.

Conditions	Metals Chelated
Basic solution containing cyanide	Pb, Sn(II), Tl(I), Bi
Slightly acid solution containing cyanide	Pd, Hg, Ag, Cu
Dilute acid solution containing thiocyanate	Hg, Au, Cu
Dilute acid solution containing thiocyanate plus cyanide	Hg, Cu
Dilute acid solution containing bromide or iodide	Pd, Au, Cu
Dilute acid solution containing EDTA	Ag, Hg
Slightly acid solution (pH 5) containing thiosulfate (carbon tetrachloride solution of dithizone)	Pd, Sn(II), Zn, (Cd,Co,Ni)
Slightly acid solution (pH 4-5) containing thiosulfate plus cyanide)	Sn(II), Zn
Citrate and tartrate in basic medium	Usually do not interfere with extraction of reacting metals

Specific mercury dithizonate extraction procedures were developed by Irving,<sup>61,63</sup> and Friedeberg.<sup>65</sup> The latter procedure permits extraction of the mercury dithizonate from about 1 N mineral acid solutions, with a sensitivity of one part of mercury in 10<sup>5</sup> parts of copper.

## 2. Di-beta naphthyl thiocarbazone

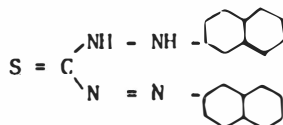



A reagent related to dithizone, but more sensitive, is di-beta naphthyl thiocarbazone.<sup>62</sup> The mercury chelate is reddish in color and is also extractable into chloroform.

3. Cupferron (Ammonium salt of N-nitroso phenyl hydroxylamine)

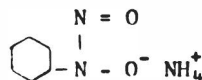

Cupferron is well known as a selective precipitant for many metals.

Its use in extraction analysis has been thoroughly reviewed by Furman.<sup>66</sup>

The chelate formed by Hg(I) and cupferron is insoluble in organic solvents; the Hg(II) chelate, formed in neutral or slightly acidic solution, is soluble in chloroform and benzene.<sup>67</sup>

4. 2-fluorenyl cupferron

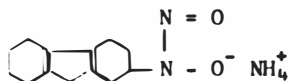

A homolog of cupferron, 2 fluorenyl-cupferron, forms white precipitates with Hg(I) in slightly acidic solution and with Hg(II) in neutral solution.<sup>68</sup> Both chelates are soluble in  $\text{CHCl}_3$  and can be reprecipitated by the addition of ligroin.

5. Sodium Diethyldithiocarbamate

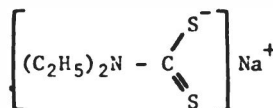

Sodium diethyldithiocarbamate is an effective extraction reagent for some twenty elements. Divalent mercury is extracted at pH 3 into ethyl acetate. At this acidity, V, Ga, Se, Mo, Ag, Cd, In, and Pu interfere. Mercury diethyldithiocarbamate is also quantitatively extracted at pH 11 from a solution containing EDTA. Under these conditions, silver, copper, palladium, bismuth, and thallium (III) are the only other metals extracted.<sup>69</sup>

6. o-Nitrosophenol

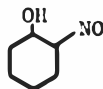

o-Nitrosophenol reacts in slightly acidic solution with Hg(II), Cu(II), Ni, and Fe(II) to form chelates extractable in ethyl ether. The chelates may be reprecipitated with petrol ether.<sup>60</sup> This reagent is stable only in solution and has, therefore, found little application.

## 7. Isonitrosoacetophenone

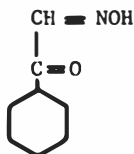

Isonitrosoacetophenone forms chelates with Fe(II), Co, Ni, Cu, Mn, Au, Cd, Pb, and Hg which can be extracted into chloroform.<sup>70</sup> The yellow Hg(II) chelate is also soluble in nitrobenzene.

b. Ion Association Extraction Systems

Unlike metal chelates, the extraction of many inorganic ion association complexes depends greatly on the nature of the extracting solvent. The ion association complexes to be extracted still have some remaining water molecules bound to the central atoms. These water molecules must be replaced by oxygen-containing molecules of the solvent before the ion association-solvent molecule complex can pass through the boundary layer between aqueous and organic phase. The selective nature of the solvent has been explained by the basicity of the oxygen atom in the respective organic solvent molecules and by stereochemical factors. Frequently, the addition of large quantities of electrolytes, 'salting-out agents', improves the distribution of the metal ion between aqueous and organic phases. The electrolyte aids the extraction by binding up water molecules under formation of aquo complexes and thus lowering the dielectric constant of the aqueous phase and also by common-ion action.

## 1. The Iodide System

The extraction behavior of most elements in the iodide system is summarized in Figure 3.<sup>71</sup> Mercury can be extracted quantitatively<sup>72,73</sup> into ethyl ether from 6.9 N hydriodic acid. Interfering elements are antimony (III), cadmium, and gold.



The percentage of mercuric bromide extracted into ethyl ether at room temperature at various hydrobromic acid concentrations<sup>75</sup> is summarized in Table X. Besides ethyl ether, methyl isobutyl ketone has been used as organic phase in bromide extractions.<sup>76</sup>

Table X. Extractability of HgBr<sub>2</sub> into ethyl ether.

Molarity of HBr	0*	0.1*	0.2	0.5	1.0	3.0	6.0
Percent Extracted	94.0	58.3	30.0	4.9	3.4	2.3	1.5

\*HgBr<sub>2</sub> was dissolved in ether; it is soluble in an aqueous medium only at higher acidities.

### 3. The Chloride System

The extraction behavior of the elements in the chloride system is shown in Figure 5.<sup>71</sup> A detailed description of the extraction conditions can be found in reference 60.

H																	He
<span style="border: 1px solid black; padding: 1px;">Li</span> Be											B	C	N	O	F	Ne	
Na	Mg											Al	Si	P	S	Cl	A
K	Ca	<span style="border: 1px solid black; padding: 1px;">Sc</span>	<span style="border: 1px solid black; padding: 1px;">Ti</span>	<span style="border: 1px dashed black; padding: 1px;">V</span>	Cr	Mn	<span style="border: 1px solid black; padding: 1px;">Fe</span>	<span style="border: 1px dashed black; padding: 1px;">Co</span>	<span style="border: 1px dashed black; padding: 1px;">Ni</span>	Cu	Zn	<span style="border: 1px solid black; padding: 1px;">Ga</span>	<span style="border: 1px solid black; padding: 1px;">Ge</span>	<span style="border: 1px solid black; padding: 1px;">As</span>	Se	Br	Kr
Rb	Sr	Y	Zr	<span style="border: 1px solid black; padding: 1px;">Nb</span>	<span style="border: 1px solid black; padding: 1px;">Mo</span>	Tc	Ru	Rh	Pd	Ag	Cd	<span style="border: 1px solid black; padding: 1px;">In</span>	<span style="border: 1px solid black; padding: 1px;">Sn</span>	<span style="border: 1px dashed black; padding: 1px;">Sb</span>	<span style="border: 1px dashed black; padding: 1px;">Te</span>	I	Xe
Cs	Ba	La	Hf	Ta	W	Re	Os	Ir	<span style="border: 1px solid black; padding: 1px;">Pt</span>	<span style="border: 1px solid black; padding: 1px;">Au</span>	<span style="border: 1px solid black; padding: 1px;">Hg</span>	<span style="border: 1px solid black; padding: 1px;">Tl</span>	Pb	Bi	<span style="border: 1px solid black; padding: 1px;">Po</span>	At	Rn
Fa	Ra	Ac															
Ce Pr Nd Pm Sm Eu Gd Tb Dy Ho Er Tm Yb Lu																	
Th <span style="border: 1px solid black; padding: 1px;">Pa</span> U Np Pu Am Cm Bk Cf E Fm Mv K2 K3																	

Figure 5. Elements extracted in chloride system. Solid blocks--appreciably extracted; broken blocks--partially extracted.

See page 211 for copyright citation.

The extraction of elements from hydrochloric acid solution into ethyl ether probably is the most thoroughly studied ion association extraction system. Many investigators have demonstrated the wide applicability of this

system both to conventional and to radiochemical separations. The extractability of mercuric chloride as a function of the molarity of hydrochloric acid at room temperature is presented in Table XI.<sup>77</sup>

Table XI. Extractability of  $\text{HgCl}_2$  into ethyl ether.

Molarity of HCl	0	0.3	3	6
Percent Extracted	69.4	13	0.4	0.2

These data show that mercuric chloride is less extractable into ethyl ether than mercuric bromide and that control of the acidity of the inorganic phase offers less control over the extraction.

Mercury (II) can be extracted to about 80 percent from a 0.125 N HCl solution and up to 82-89 percent from 0.1 N HCl into a mixture of n-butylacetate + 3 M trichloroacetic acid.<sup>77</sup>

#### 4. The Fluoride System

It is of interest to note that fewer elements are extracted to any extent as fluorides in the hydrofluoric acid-ethyl ether system than in the chloride, bromide, thiocyanate, and nitrate systems. The data given in Table XII on the extractability of mercuric fluoride into ethyl ether from various hydrofluoric acid concentrations at room temperature are taken from reference 78.

Table XII. Extractability of  $\text{HgF}_2$  into ethyl ether.

Molarity of HF	1	5	10	15	20
Percent Extracted	0.05	0.05	0.05	0.9	2.7

The extraction behavior of the elements is summarized in Figure 6.<sup>71</sup>

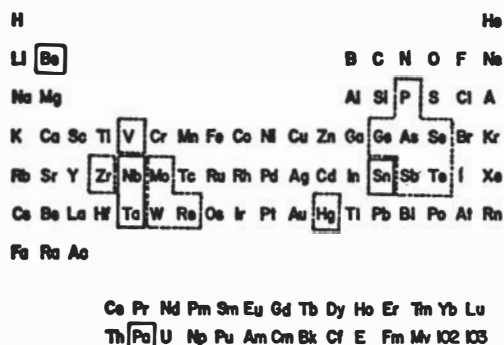

Figure 6. Elements extracted in fluoride system. Solid blocks--appreciably extracted; broken blocks--partially extracted.

See page 201 for copyright citation.

## 5. The Thiocyanate System

A thorough study of the extraction of many metal thiocyanate concentrations has been made by Bock.<sup>79</sup> The data on the extractability of mercuric thiocyanate into ethyl ether, as given in Table XIII, imply that this system is not useful for the extraction of mercury, however, it may be of potential value for separating other metal ions from mercury.

Table XIII. Extractability of  $\text{Hg}(\text{SCN})_2$  into ethyl ether.

$\text{Hg}(\text{SCN})_2$ concn. in aq. phase before extract. (moles/l)	Molarity of $\text{NH}_4\text{SCN}$ (moles/l)	HCl Acidity	Volume Ratio ether; water	HSCN concn. in ether (moles/l)	Percent Extracted
0.2	0.4	neutral	1:1	-	0.15
0.2	1.0	neutral	10:1	-	0.15
0.2	7.0	neutral	10:1	-	0.65
0.5	1.0	neutral	6:1	0.5	2.2
0.5	7.0	neutral	6:1	0.5	1.4

The extraction behavior of the elements in the thiocyanate system is presented in Figure 7.<sup>71</sup>



### c. Other Systems

The extraction systems described in this section are related to ion association systems. The ligands replacing coordinated water molecules around the metal ions are derivatives of the tri-alkylphosphine oxide tri-alkylphosphine sulfide series. A considerable amount of work on these extraction systems has been published in tabular form by Ishimori.<sup>82-84</sup>

Only qualitative information regarding the extraction of mercury with tri-n-dodecylamine (TDA)<sup>84</sup> is available to date.

Another extraction system to be listed here is that where the metal ions, as anions, form salts with high molecular weight cations such as tetraphenylphosphonium, -arsonium, and -stibonium ions. The solubility of such 'salts' in organic solvents makes them useful for solvent extractive separations.

A 0.1 M tri-alkylphosphine oxide solution in kerosene extracts completely Cr(VI), Au(I), Hf, Fe(III), Mo(VI), Zr(IV), U(VI), and Zn from 1 M HCl solutions.<sup>60</sup> Under these conditions, partial extraction is obtained for Sb(III), Bi, Cd, In, Hg(II), Pt(II), and Zn.

White and Ross<sup>85</sup> in their monograph "Separations by Solvent Extraction with Tri-n-octylphosphine Oxide" mention that cadmium and mercury are extracted to a very slight extent from acid chloride solutions, but are not extracted from other inorganic acids.

The extraction behavior of some 60 elements in hydrochloric acid toward 1 percent tri-n-butylphosphine oxide (TBPO) in toluene was studied in detail by Ishimori, Watanabe, and Fujino.<sup>82</sup> The logarithms of the observed distribution ratios,  $K_D$ , are plotted in Figure 9 as a function of the normality of the hydrochloric acid solution extracted. The magnitude of the distribution ratio,  $K_D$ , of mercury indicates that this element extracts moderately well in the 1 percent-TBPO-Toluene system. An increase in the concentration of TBPO up to 100 percent does not improve the extractability of mercury.<sup>86</sup>

Tri-n-butylphosphine sulfide was found<sup>87</sup> to be a considerably more selective extractant for mercury (II) and silver than the trialkylphosphine oxides. The distribution ratios, D, of mercury and silver between aqueous



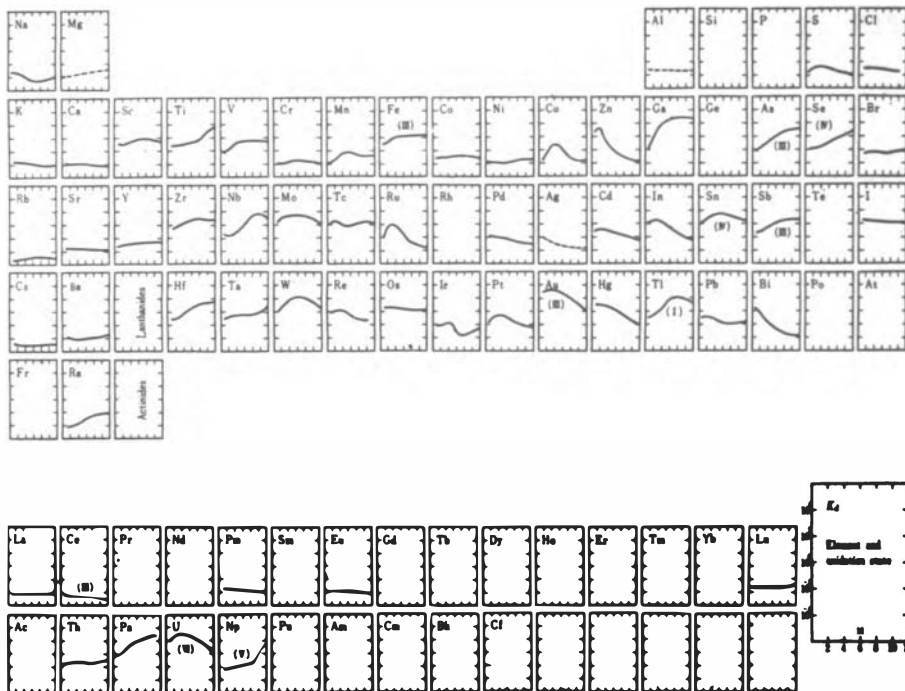

Figure 9. Dependence of the distribution ratio  $K_D$  on normality of HCl in the 1% TBPO system.

and organic phases after a 30-minute contact of equal volumes of a 5% solution (v./v.) of tri-n-butylphosphine sulfide in  $\text{CCl}_4$ , and a  $10^{-2}$  M solution of the respective metal were found to be 282 for mercury and 625 for silver. Tri-n-butylphosphine sulfide as a practical extractant for mercury suffers from the disadvantage that it is extremely difficult to strip mercury from the organic phase, even with reagents such as nitric acid, aqua regia, or sodium peroxide.

In accord with above, triisooctyl thiophosphate (TOTP) and tri-n-butyl thiophosphate (TBPS), the neutral esters of monothiophosphoric acid are also highly selective extractants for silver and mercury from nitric acid solutions.<sup>88</sup> The equilibrium between ions to be extracted in aqueous and organic phases is rapidly established and the partition can easily be reversed. Partition coefficients of mercuric ion from aqueous nitric acid solutions at various concentrations of TOTP are presented in Figure 10.

The partition coefficients of mercury (II) as a function of TOTP concentration at different nitric acid concentrations are summarized in Figure 11.

An aqueous phase 6 N in nitric acid and an organic phase 0.669 M of TOTP in  $\text{CCl}_4$  extracts 97% of the mercury present after two 2-minute equilibrations. The presence of salting-out agents, as is illustrated in Table XIV, permits the elimination of a second equilibration. Stripping the mercury from the organic phase is easily accomplished with water.

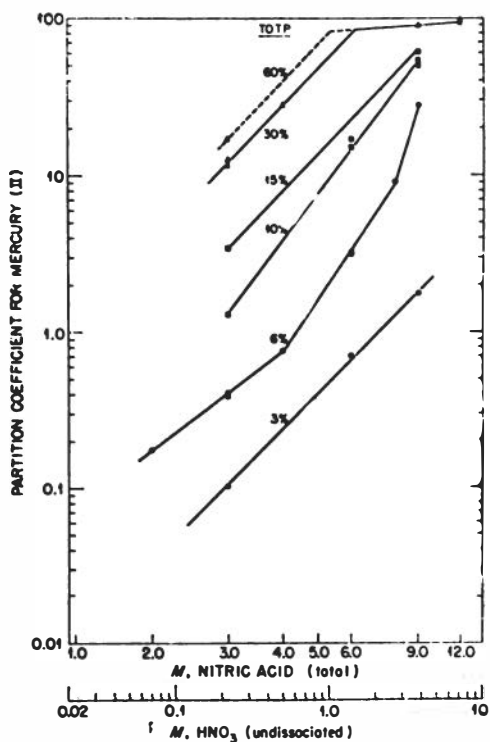

Figure 10. Partition coefficient of  $\text{Hg(II)}$  from aqueous  $\text{HNO}_3$  solutions at various concentrations of TOTP

$\text{Hg concn.}, 0.050M$ , initially, temp.,  $25^\circ\text{C}$ .

See page 201 for copyright citation.

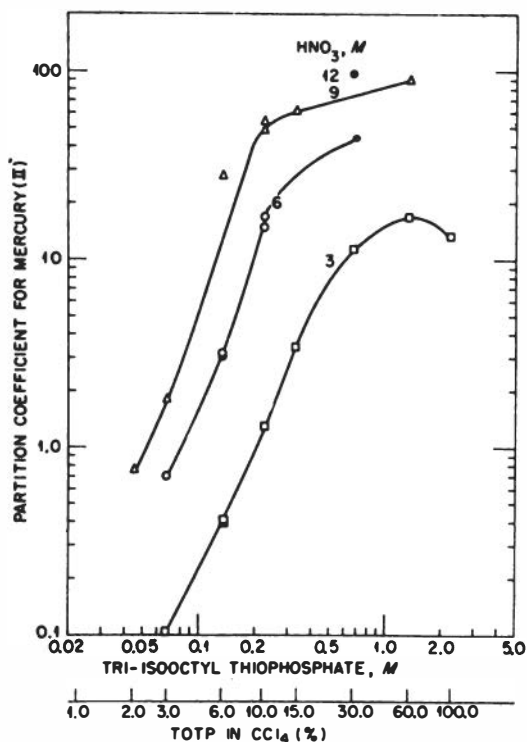

Figure 11. Partition coefficient of  $\text{Hg(II)}$  as a function of reagent concentration for various concentrations of  $\text{HNO}_3$

$\text{Hg concn.}, 0.050M$ , initially

See page 201 for copyright citation.

Metal ions which form insoluble sulfides were found<sup>89</sup> to extract to an appreciable extent into a solution of di-n-butyl phosphorothioic acid in carbon tetrachloride. Since as little as 2 ppb of mercuric ion can be quantitatively extracted in one equilibration from an aqueous phase 0.5 N in mineral acid into an organic phase of 5% (w/v.) di-n-butyl phos-

Table XIV. Effect of anions and acids on the extraction of mercury.

Sample Tested	Concentration Moles	Partition Coeff. of Hg
ANIONS <sup>a</sup>		
...	...	44
Acetate	1.0	100; 32 <sup>b</sup>
Chloride (as acid)	2.0	0.001 <sup>b</sup>
Fluoride	1.0	1.7 <sup>c</sup>
Nitrate	3.0	34.5
Perchlorate (as acid)	1.0	250
Sulfate (as acid)	1.0	4.5 <sup>b</sup>
	6.0	9.0 <sup>b</sup>
ACIDS <sup>d</sup>		
Acetic	1.0	80
Hydrofluoric	1.0	1.3 <sup>c</sup>
Nitric	6.0	90
	9.0	100
Perchloric	1.0	50

<sup>a</sup> 30 volume percent (0.67M)TOTP in CCl<sub>4</sub>, contacting an aqueous phase 0.500M in mercury (II) nitrate and 6M in nitric acid.

<sup>b</sup> Extraction made with 0.223M TOTP; with 6M nitric acid alone partition coefficient is 17.

<sup>c</sup> Precipitate at interface.

<sup>d</sup> 30 volume percent (1.06M) TBPS in CCl<sub>4</sub>, contacting an aqueous phase 0.0500M in mercury (II) nitrate.

See page 201 for copyright citation.

phorothioic acid in carbon tetrachloride, this extraction system is of considerable importance to the radiochemistry of mercury.

The logarithm of the distribution ratios, D, of some 30 elements are presented as a function of the logarithm of the hydrogen ion concentration of the aqueous phase, both in hydrochloric acid and in sulfuric acid, in Figures 12 and 13. The dashed lines in these figures represent distribution ratios where the electrolyte concentration of the aqueous phase is  $\geq 0.25M$ . The effect of electrolyte concentration and solvent for the extractant on the distribution ratio D for mercuric ion is shown in Table XV.

The relative order of extraction of the metal di-n-butyl phosphorothioate complexes was determined by displacement of one metal ion by another and was found to be:

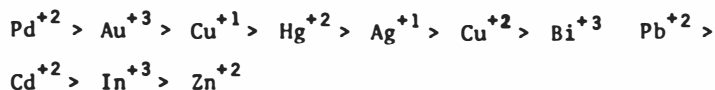

The selectivity in actual separations can be improved if the extractant used is a metal di-n-butyl phosphorothioate rather than the free acid. Generally, the metal di-n-butyl phosphorothioates have a greater chemical

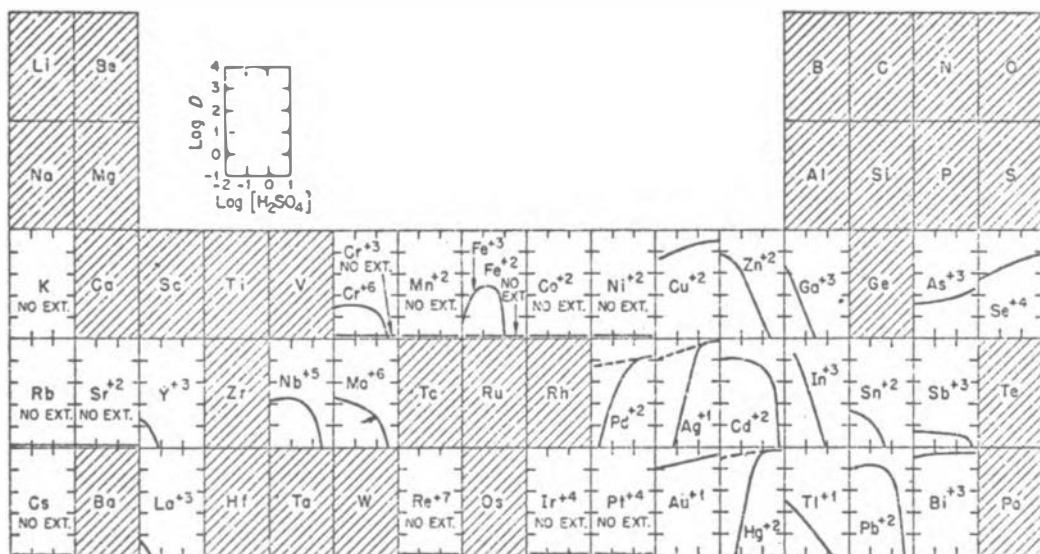

Figure 12. Extraction of metal ions from  $H_2SO_4$  with di-n-butyl phosphorothioic acid •

Organic phase. 0.221M  $(C_4H_9O)_2P(O)SH$  in  $CCl_4$   
 Aqueous phase.  $[H_2SO_4]$ ,  $N$  shown [metal ion], 0.5 mg./ml.  
 Volume of each phase, 5 ml.

See page 201 for copyright citation.

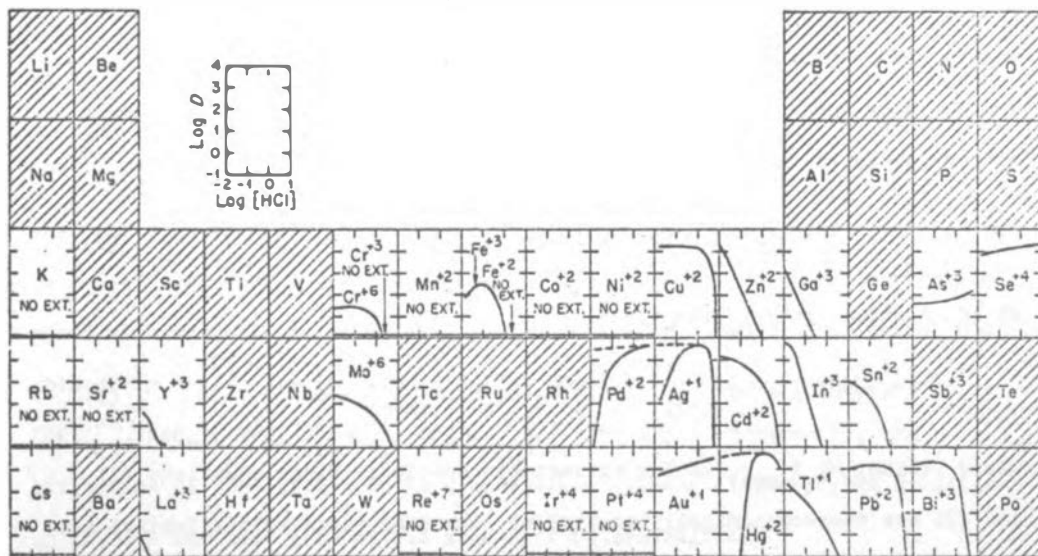

Figure 13. Extraction of metal ions from  $HCl$  with di-n-butyl phosphorothioic acid •

Organic phase. 0.221M  $(C_4H_9O)_2P(O)SH$  in  $CCl_4$   
 Aqueous phase.  $[HCl]$ ,  $N$  shown [metal ion], 0.5 mg./ml.  
 Volume of each phase, 5 ml.

See page 201 for copyright citation.

stability and, accordingly, are less subject to undesirable hydrolysis and oxidation reactions as compared to the free acid. Thus, the use of a metal di-n-butyl phosphorothioate as an extractant for those metal ions that are higher in the displacement series can be of advantage.

Table XV. Effect of solvent on distribution ratio of  $\text{Hg}^{++}$ .

Solvent	Distribution Ratio D	
	0.05N HCl	0.5N HCl
Isoamyl alcohol	9,000	$\geq 10,000$
n-Butyl alcohol	$\geq 10,000$	$\geq 10,000$
Benzyl alcohol	2,800	$\geq 10,000$
Isoamyl acetate	430	920
Ethyl acetate	400	600
Isopropyl ether	220	290
Carbon tetrachloride	100	4,800
o-Dichlorobenzene	5	$\geq 10,000$
Chloroform	35	1,800
Benzene	6	1,600
n-Hexane	53	$\geq 10,000$
Toluene	110	$\geq 10,000$
Xylene	25	2,000

See page 201 for copyright citation.

Long-chain trialkyl amines<sup>84</sup> have been found to be potent extracting agents for uranium thionium, the actinides, and the rare earths. The mechanism of amine extraction can be described either as an adduct formation between a neutral metal complex and the ammonium salt:

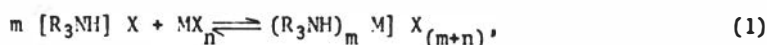

or as an anion exchange reaction:

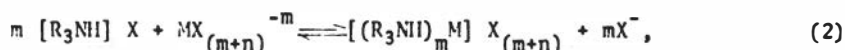

where  $[(\text{R}_3\text{NH})_m \text{M}] \text{X}_{(m+n)}$  is the extractable species. Since equations (1) and (2) are thermodynamically equivalent, the long-chain trialkylamines are often called 'liquid anion exchangers'.<sup>90</sup>

In analogy with the adsorption on anion exchangers, the elements extracted with long-chain tertiary amines can be classified into three groups:

1. Elements that are not extracted (adsorbed) from hydrochloric acid at any concentration. In this group are the alkali metals, the alkaline earths, and the elements of Group III B of the Periodic Table.

2. Many elements show increasing extraction with increasing hydrochloric acid concentration; some of these elements even exhibit extraction (adsorption) maxime.
3. Elements which form stable complexes with chloride ions generally show a decreasing extraction (adsorption) with increasing hydrochloric acid concentration. Mercury is a member of this group.

Specifically, the extraction of mercury by tri-n-dodecylamine (TDA) in xylene<sup>83</sup> was found to be almost quantitative from 1 to 6 N HNO<sub>3</sub> and from 0.1 to 8 N HCl and decreased slightly at higher acidities.

In solvent extraction experiments using methyl-di-octylamine (MDOA) in chloroform<sup>91</sup> the distribution coefficient of mercury again decreased with increasing nitric acid concentration in close analogy to the behavior described above and to the anion exchange behavior in nitric acid.<sup>92</sup> Under the experimental conditions of this study, the distribution coefficient of mercury ranged from -1 at 0.2 N HNO<sub>3</sub> to  $-10^{-2}$  at approximately 6 N in HNO<sub>3</sub> and thus were too low to be analytically useful.

Without giving details for a procedure, Willard and Perkins<sup>93</sup> state that the high molecular salts which precipitate when tetraphenyl phosphonium chloride, tetraphenyl arsonium chloride, and tetraphenyl stibonium chloride react with mercuric chloride can be extracted from an aqueous solution into chloroform. Also precipitated and thus interfering are the anions SnCl<sub>6</sub><sup>2-</sup>, CdCl<sub>4</sub><sup>2-</sup>, ReO<sub>4</sub><sup>-</sup>, TcO<sub>4</sub><sup>-</sup>, MnO<sub>4</sub><sup>-</sup>, IO<sub>4</sub><sup>-</sup>, ClO<sub>4</sub><sup>-</sup>, and BF<sub>4</sub><sup>-</sup>. Apparently, the extraction of such salts can be accomplished without difficulty at acidities up to -1 N and that free nitric acid must be neutralized.

#### (10) Ion Exchange Behavior of Mercury

A review of the standard reference works on ion exchange<sup>94-98</sup> and the pertinent analytical literature revealed that most of the work reported on mercury was part of a more general investigation on the behavior of some 60 "most common" elements that the majority of papers on mercury ion exchange dealt with anion exchange systems.

In the following an attempt was made to collect the fairly scattered information on the exchange behavior of mercury and to present those facts which are of potential value to the radiochemist.

a. Anion Exchange Behavior of Chloro Complexes

Andelin and Davidson<sup>99</sup> compared the adsorption of mercuric ions and cupric ions on the weak base anion exchange resin Amberlite IR-4B. Their experimental results on the adsorption of Hg(II) are presented in Table XVI.

Table XVI. Adsorption of mercuric ions on Amberlite IR-4B.

[Hg <sup>++</sup> ] in resin m/l	[Hg <sup>++</sup> ] in solution m/l	[H <sup>+</sup> ] in resin m/l	[H <sup>+</sup> ] in solution m/l	H <sup>+</sup> liberated Hg <sup>++</sup> adsorbed
.0	0	4.52	0.0040	-
0.22	0.000025	4.12	0.0077	1.7
0.50	0.00049	3.84	0.0100	1.2
0.67	0.0043	3.35	0.0142	1.3
0.81	0.0029	3.35	0.0142	1.2*
1.01	0.0120	2.55	0.0207	1.7
1.13	0.0218	2.24	0.0221	1.6

\* See Text

The experimental conditions were as follows: 1 gm resin/100 ml aqueous phase, constant stirring, temperature 28.3 °C, ionic strength 0.09 to 0.10, equilibrium time 8 days, except marked \* where equilibrium was maintained for 16 days. To avoid possible precipitation of basic mercury salts, the solutions initially were at pH of about 2 and the resin was 4 to 5 molar in hydrogen ion. After 8 days, a large fraction of the mercuric ion was adsorbed on the resin. The ratio of hydrogen ion liberated to mercuric ion adsorbed was greater than unity.

The greater affinity of the resin for mercuric ion as compared to cupric ion is in accordance with the relative affinity of ammonia for these two ions:

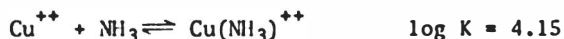
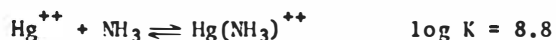

A more frequently used anion exchange resin is Dowex-2. Hicks and co-workers<sup>100</sup> studied the qualitative anionic behavior of a number of metals on a Dowex-2 column. The metals were segregated into groups according to their elution behavior with 3 M HClO<sub>4</sub>, 1 M NH<sub>4</sub>OH, 1 M NaOH, and various concentrations of HCl. An element was considered to elute if 4 ml of solvent (4 free column volumes) eluted the element completely. If the element was undetected in the eluate, or if a small fraction of that adsorbed was found, the next eluting agent was tried. Table XVII summarizes the results of this investigation.

Table XVII. Elution of elements from Dowex-2 anion exchange resin.

Eluting Agent	Elements Eluted
12 M HCl	alkali metals, alkaline earths, Sc, Y, Ti(III), V(II) (III) (IV), Ni, As(III) (V), Se(IV) (VI), Tl(I), Pb, Bi, Cu(II) slowly, Al, Cr(III), Te(II), Mn(II)
6 - 9 M HCl	Ti(IV), V(V), Ag*, Ta*, Pt(II), Zr, Hf
3 - 6 M HCl	Fe(III), Co, Ge, Nb*
1 - 3 M HCl	Zn, Ga, Mo(VI), In, Sn(IV), Te(IV) (VI), Au (as AuI <sub>2</sub> <sup>-</sup> ), Pb(II)
below 0.01 M HCl	Sn(II), Hg(II), Sb(V) slowly
3 M HClO <sub>4</sub>	Po, Cd, Sb(III), Sb(V) slowly
1 M NH <sub>4</sub> OH	Pd, Ag, Sb(III), Sb(V)
1 M NaOH	W
not eluted	Tc*, Ru, Rh, Re, Os, Ir, Pt(IV), Au(III), Tl(III)

\* in trace concentration only



Kraus and Nelson<sup>98,101</sup> determined the variation of the distribution ratios of some 60 elements on Dowex-1x8 as a function of the hydrogen ion concentration of the aqueous phase. The results of this investigation are summarized in Figure 14.

Since the activity coefficients of LiCl and HCl in the resin phase do not differ appreciably, it was anticipated<sup>102</sup> that the adsorbabilities of elements in LiCl are very similar to those in HCl solutions of the same molarity. Surprisingly, the adsorption of metal ions from LiCl solutions on Dowex-1 was found to be greatly enhanced over those from HCl solutions of the same molarity. There is no explanation for this behavior at this time.

Mizumachi<sup>103</sup> studied the adsorption of mercuric ions in mixed HCl-LiCl solutions on an anion exchanger and confirmed in a general way the observations of Kraus and Nelson.<sup>96-99</sup>

In a study on the fixation of complex chlorides on Dowex-2x10, Tremillion<sup>104</sup> found that the amount of mercury (II) retained in the resin exceeded greatly its theoretical capacity for a singly charged ion. He explains this observation as follows: On one hand, the exchange equilibria

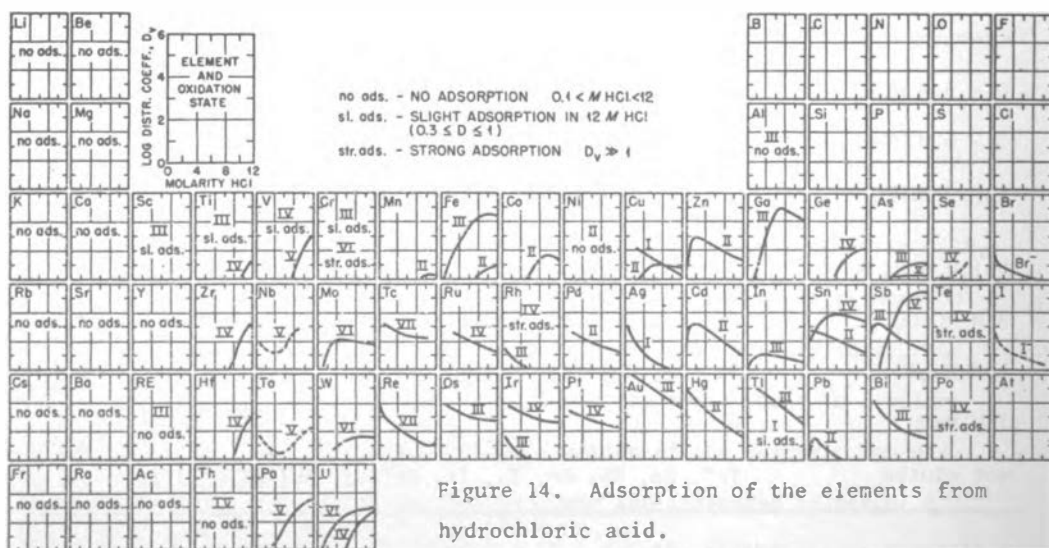

proceed almost quantitatively from left to right. On the other hand, the concentration of undissociated  $\text{HgCl}_2$  is of importance in that it enters the resin with a constant partition coefficient which must be of the order of unity. In the presence of  $\text{NaCl}$  in solution, however, the concentration of  $\text{HgCl}_2$  is decreased by formation of  $\text{HgCl}_3^-$  and  $\text{HgCl}_4^{--}$ . The amount of resin retained by the resin then is expected to decrease with increasing  $\text{NaCl}$  concentration which was shown experimentally to be the case.

In an ion-exchange analysis scheme<sup>105</sup> for the rapid (<2 hours) separation of some forty elements, mercuric ion is adsorbed on a 200-400 mesh Dowex-2x10 chloride column and is eluted sequentially with Mo, Tc, Ru, Ag, Cd, W, Re, Os, Ir, and Au with 0.1 N  $\text{HCl}$ .

#### b. Anion Exchange Behavior of Bromo Complexes

Anderson and Knutsen<sup>106</sup> made a comparative study on the adsorption on Dowex-1x8 of cations with an 18-electron configuration from  $\text{HCl}$  and  $\text{HBr}$  solutions. Cations with an 18-electron configuration are said to have a tendency to form bromo complexes rather than chloro or fluoro complexes. In the concentration range 1 N to 7 N in  $\text{HBr}$ , mercuric ion was found to be somewhat stronger adsorbed than from  $\text{HCl}$  solutions of the same molarity. The dependence of the distribution ratio on acidity in  $\text{HBr}$  has the same features than that in  $\text{HCl}$  solution, namely it decreases slowly when the acidity changes from low to high values, as shown in Figure 15.

The distribution of trace mercury ions between Dowex-1 and solutions of  $\text{HCl}$ ,  $\text{LiCl}$ ,  $\text{LiBr}$ , and  $\text{NaCl}$ ,  $\text{NaBr}$ , and  $\text{NaI}$  was studied by Marcus and Eliezer<sup>107</sup>. The general trend of distribution coefficients was found to be  $D(\text{I}) > D(\text{Br}) > D(\text{Cl})$  and is presented in Figure 16.

#### c. Anion Exchange Behavior of Fluoro Complexes

The elution characteristics of some 50 elements in hydrofluoric acid solution from 200 mesh Dowex-1x10 were studied by Faris<sup>108</sup> and are

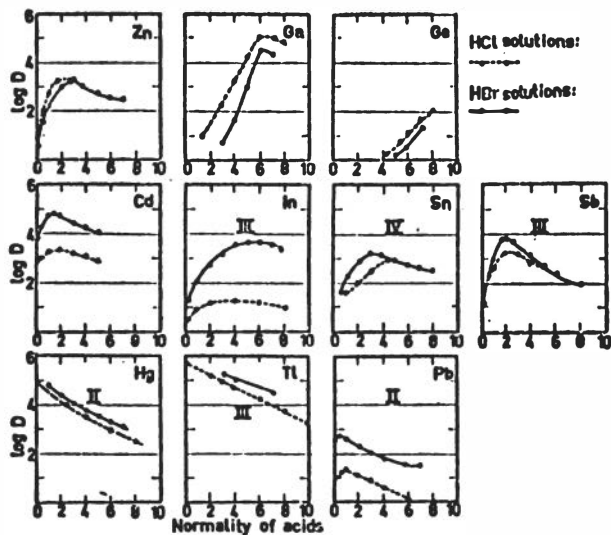

Figure 15. Adsorption of some elements with 18 electron configuration and of Sb(III), Pb(II) from HBr and HCl solutions.

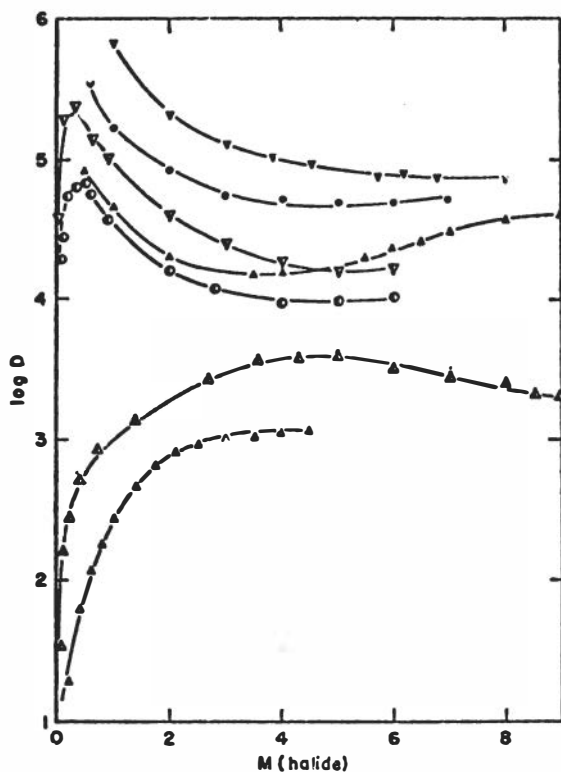

Figure 16. Distribution coefficients ( $\log D$ ) of mercury (filled points), cadmium (half-filled points) and zinc (empty points) vs. halide molarity:  $\Delta$  lithium chloride,  $\circ$  sodium bromide, and  $\nabla$  sodium iodide solutions.

summarized in Figure 17. The adsorbability of every element that forms an ionic complex in hydrofluoric acid decreases with increasing acid molarity with the exception of niobium.

Since the method of analysis, spectrography, required evaporation of hydrofluoric acid solutions on copper electrodes, it was not possible to recover quantitatively the mercury (II) at all acid concentrations, probably due to volatilization.

The elements in the center of the second and third long rows of the periodic system (ruthenium to cadmium and osmium to mercury) form very strong chloride complexes and weaker fluoride complexes. In the presence of significant amounts of chloride ions, hydrofluoric acid is not expected to affect appreciably their adsorbabilities on an anion exchange resin.<sup>109</sup>

In a scheme for the rapid separation of some thirty elements entirely by ion exchange techniques, mercury is adsorbed on a Dowex-1 column from dilute (~2N) HF and thus separated from the bulk of the other elements

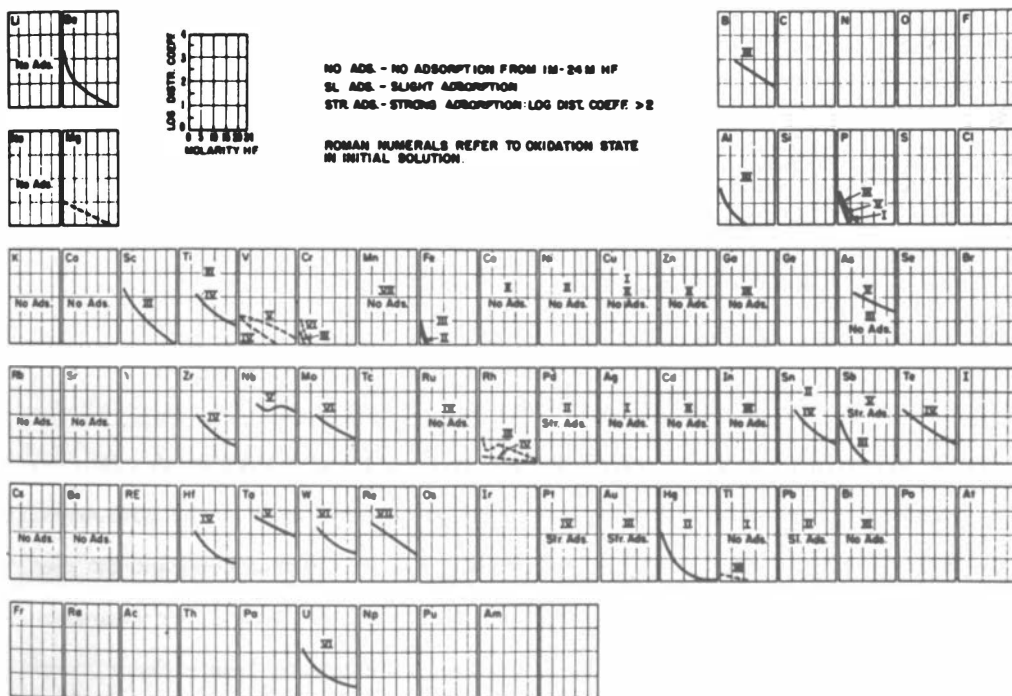

Figure 17. Removal of elements from solution in 1M to 24M hydrofluoric acid with 200-mesh anion exchange resin.

See page 201 for copyright citation.

studied.<sup>110</sup> The elution of mercury is accomplished with 20 N HF. This particular separation scheme was developed for activation analysis applications.

#### d. Anion Exchange Behavior of Mercury in the Nitrate System

The adsorption characteristics of some 60 elements in nitric acid solution were studied by Buchanan and Faris<sup>111</sup> and by Ishikawa<sup>92</sup> with a strong-base anion exchange resin and are summarized in Figure 18.

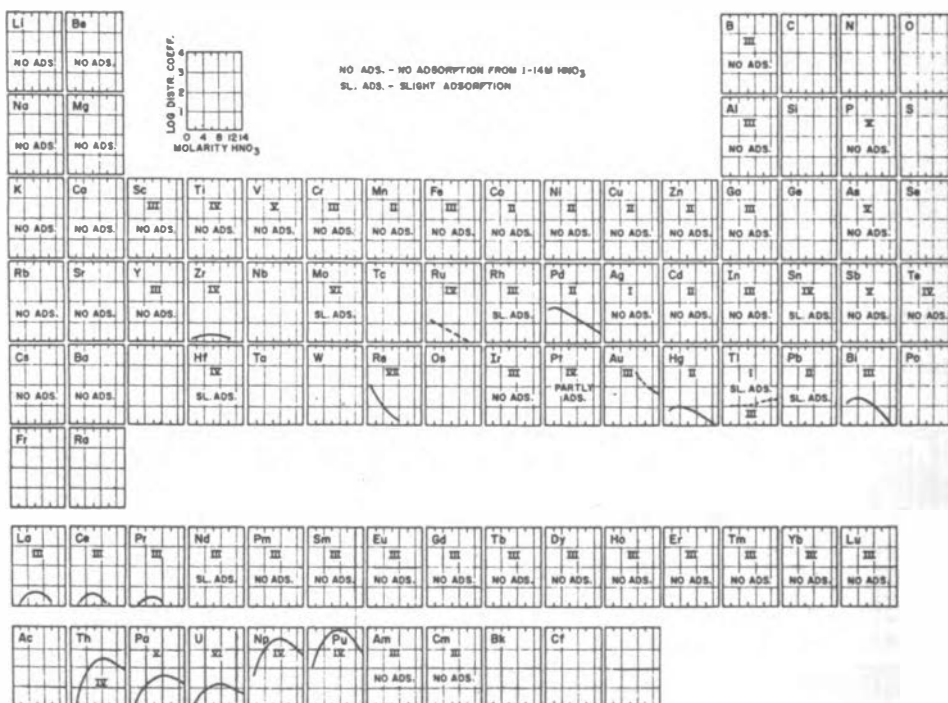

Figure 18. Removal of elements from solution in 1M to 14M nitric acid with a strongly basic anion-exchange resin.

Most elements are not adsorbed in the range from 1 to 14 M of acid. Mercury (II) is decreasingly adsorbed with increasing acid concentration. The adsorbability of an element can be increased by decreasing the dielectric constant of the aqueous phase by addition of organic compounds such as alcohols or ketones. Fritz and Greene<sup>112</sup> found that the adsorption of elements from mixed nitric acid-isopropyl alcohol solutions is greatly enhanced over that from nitric acid alone. Some representative examples are listed in Table XVIII.

Table XVIII. Distribution Coefficients and Elution Volumes  
in 1.5M HNO<sub>3</sub>-85% Isopropyl Alcohol on Amberlyst XN-1002

Metal Ion	Distribution coefficient, 0.1 mmole/50-ml. load	Elution volume, ml., on 16-cm. column, 0.25-mmole load
Mg(II)	2.3	75
Ca(II)	56	...
Sr(II)	187	...
Sc(III)	22	...
Y(III)	85	...
Zr(IV)	16	...
Ti(IV) with H <sub>2</sub> O <sub>2</sub>	9.9	220
V(IV)	6.7	100
V(V)	15	>200
Mn(II)	6.7	130
Fe(III)	3.3	140
Co(II)	5.8	110
Ni(II)	5.4	110
Cu(II)	14	175
Zn(II)	3.2	110
Cd(II)	65	...
Hg(II)	228	...
Ag(I)	17	...
Al(III)	2.6	120
Ge(III)	3.8	130
In(III)	9.1	150
Pb(II)	1100	...
Bi(III)	1300	...
Tb(III)	85	...
Dy(III)	180	...
Sm(III)	866	...
Md(III)	2200	...
La(III)	5900	...

See page 201 for copyright citation.

e. Anion Exchange Behavior of Mercury in the Tartrate System

The feasibility of separating transition metals as tartrate complexes on an anion exchanger was established by Morie and Sweet.<sup>113</sup> For example, microgram quantities of Zn, Cd, and Hg, as tartrates, could be separated cleanly on a 4.5 cm long and 0.8 cm i.d. column of 200-400 mesh Dowex-2x-8 at pH of 2.5 as shown in Figure 19.

The variation of the distribution coefficient  $K_D$  of mercury as with pH and tartrate concentration is shown in Figure 20.

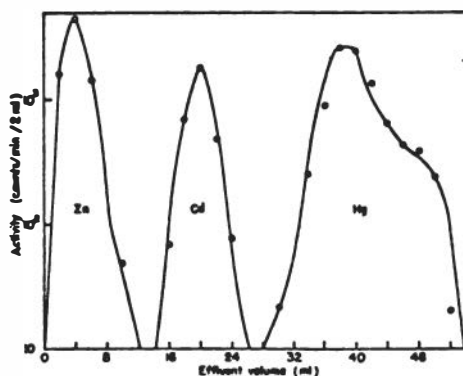

Figure 19. Elution of zinc, cadmium, and mercury.

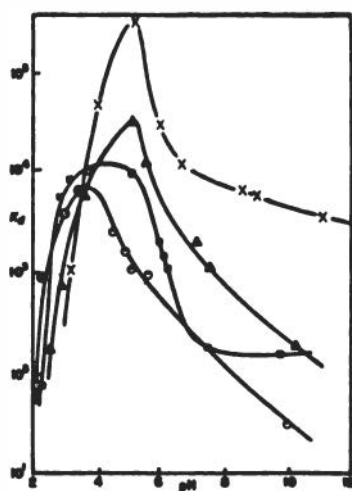

Figure 20. Variation of the distribution coefficient for mercury with pH and tartrate concentration.  $\odot$  - in  $8.5 \cdot 10^{-2}$  M tartrate;  $\square$  -  $4.25 \cdot 10^{-2}$  M tartrate;  $\triangle$  - in  $2.12 \cdot 10^{-2}$  M tartrate;  $\times$  - in  $2.12 \cdot 10^{-3}$  M tartrate.

### Cation Exchange Behavior of Mercury in Hydrochloric and Perchloric Acid Solution

The first systematic study of the cation exchange behavior of mercury (II) on Dowex-50W-X8 (50-100 mesh) from hydrochloric acid solution was carried out by De and Majumdar<sup>114</sup> who established that mercury can be recovered quantitatively from the cation exchanger by elution with 0.5-4N hydrochloric acid, 1.5-4N nitric acid, 3-4N sulfuric acid, and 3-4N ammonium acetate. The eluting

agents can be arranged in order to decreasing efficiency as:



As part of an attempt to devise an ion exchange analysis scheme, adaptable to trace and micro concentrations and embracing essentially all elements, Nelson, Murase, and Kraus<sup>115</sup> studied the cation exchange behavior of some 60 elements on Dowex 50-X4 both from hydrochloric acid and perchloric acid solution. Their results are summarized in Figures 21 and 22. The large differences in adsorbabilities in these two media particularly at high ionic strength are striking and may lead to new separations.

The adsorbability of mercury on Dowex 50-X4 as a function of molarity of hydrochloric and perchloric acids is presented in Figure 23.

Figure 23 illustrates the principle involved in cation-exchange separations<sup>116-120</sup> of mercury from other ions: most cations are retained on the resin while mercury is only faintly adsorbed and can easily be eluted with dilute hydrochloric acid.

Mercury can be separated rapidly<sup>120</sup> from Cd, Zn, and Cu by adsorbing these elements in dilute acid solution on a 200-400 mesh Dowex 50-X4 column, 16 cm long and 7 mm inside diameter, and eluting them with 0.4 N HCl in the order shown in Figure 24.

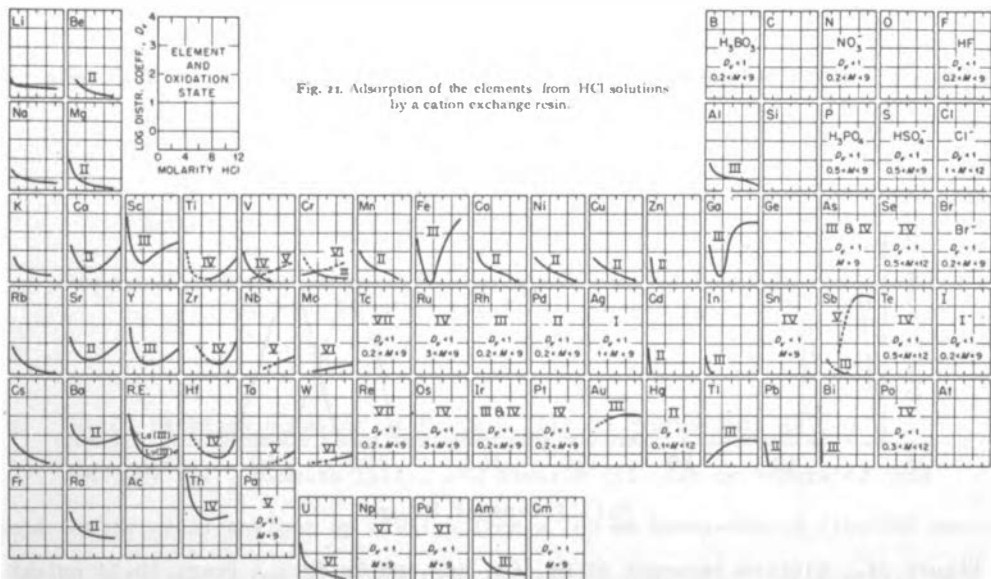

Fig. 21. Adsorption of the elements from HCl solutions by a cation exchange resin.



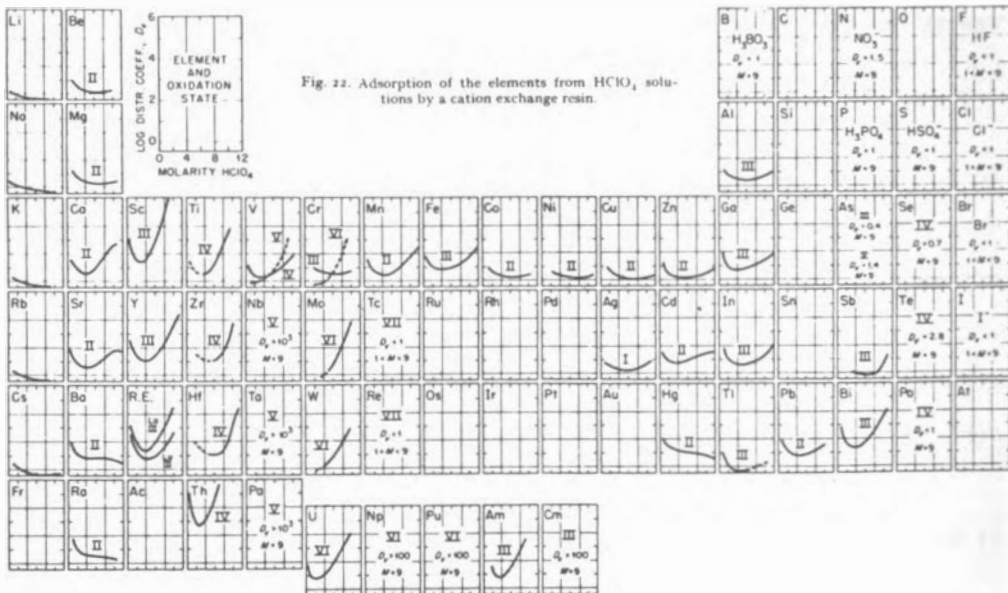

Fig. 22. Adsorption of the elements from  $\text{HClO}_4$  solutions by a cation exchange resin.

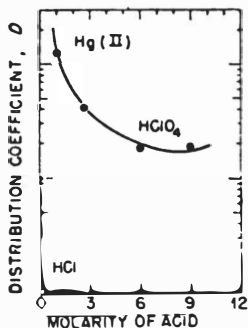

Figure 23. Distribution coefficients for  $\text{Hg(II)}$  as a function of acid molarity.

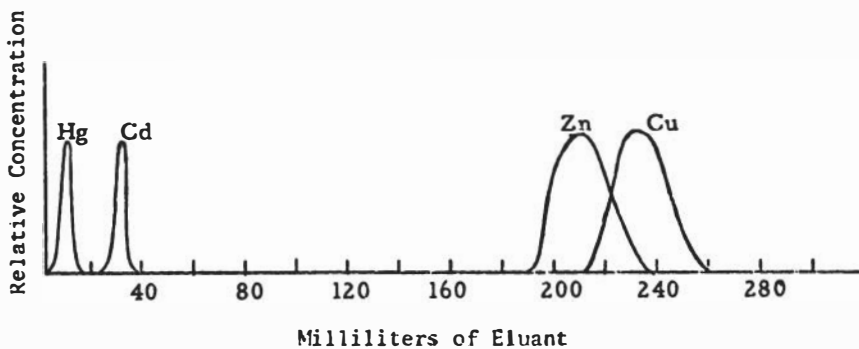

Figure 24. Elution sequence of  $\text{Hg}$ ,  $\text{Cd}$ ,  $\text{Zn}$ , and  $\text{Cu}$  from a Dowex 50-X4 column.

The presence of quantities of phosphoric acid equivalent to 50 mg of phosphorous per milliliter of solution no observable change in elution was obtained for any of the three ions. From an analytical standpoint, the relative amount of phosphorous will rarely, if ever, exceed this amount. Quantities of sulfur as sulfate equivalent to that of the positive ions present about 5 mg/ml, had also no observable effect on the elution curve.

It has been known for a long time that amino polyacetic acid type compounds, such as EDTA, form very stable chelates with a large number of metal ions. An application of the chelating property of EDTA to ion exchange separations has been published by Fritz and Umbreit.<sup>121</sup> These authors used short Dowex 50 columns to filter cationic species out of solutions containing a mixture of elements plus EDTA. The retention of cations by the resin is a rather sharp function of the pH, as shown in Figure 25, yet there is sufficient difference between certain mixtures of elements to allow simple and rapid separations to be made.

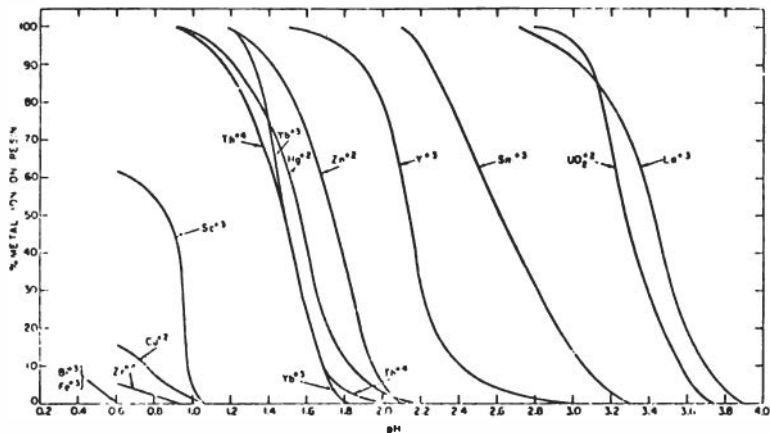

Figure 25. Retention of different metal ions by Dowex-50 resin as a function of pH of solutions containing EDTA.

#### g. Cation Exchange Behavior of Mercury (II) in Hydrobromic Acid

Mercury (II), bismuth (III), and cadmium (II) can be separated from most other metal cations by elution from a 160 mm Dowex-50W-X8 (100-200 mesh) cation exchange column with 0.3 to 0.5 N hydrobromic acid.<sup>122</sup> The elution

behavior of individual metal ions from a 12 x 160 mm Dowex-50W-X8 column with 0.5 N hydrobromic acid is summarized in Table XIX.

Table XIX. Elution of individual metal ions from 1.2 x 16 cm Dowex 50W-X8 cation exchange column using 0.5M HBr.

Metal Ion	0.5M HBr, ml.		Metal Ion	0.5M HBr, ml.	
	Break-through	Elution complete		Break-through	Elution complete
Al	>200	...	Na	0-10	>200
Au(I)	80	140	Ni	>200	...
Ba	>200	...	Pb(II)	100	240
Be	60	>200	Sb(III)	0-10	120
Bi(III)	0-10	60	Sc	>200	...
Ca	>200	...	Sn(VI)	40	140
Cd	20	100	Sr	>200	...
Co(II)	>200	...	Th	>200	...
Cr(III)	>200	...	Ti(VI)	>200	...
Cu(II)	>200	...	U(VI)	>200	...
Dy	>200	...	V(V)	180	>200
Fe(II)	>200	...	Y	>200	...
Fe(III)	>200	...	Zn	>200	...
Ga	>200	...	Zr	>200	...
Hg(II)	0-10	40			
In	>200	...			
K	0-10	>200			
La	>200	...			
Lu	>200	...			
Mg	>200	...			
Mn(II)	>200	...			
Mo(VI)	0-10	140			

See page 201 for copyright citation.

Using different concentrations of hydrobromic acid (0.1 to 0.6 N) as eluent, mercury (II), bismuth, cadmium, and lead (II) can be separated from each other and from other metal ions as can be deduced from Table XX.

#### h. Cation Exchange Behavior of Mercury (II) in Hydrofluoric Acid

The use of hydrofluoric acid as eluent for separating metal cations on Dowex-50W-X8 (100-200 mesh) resin has been reported by Fritz, Garralda, and Karraker.<sup>123</sup> Metal cations can be separated into groups that form fluoride complexes and are rapidly eluted and those that remain on the column;

Table XX. Elution of individual ions from 1.2 x 16 cm. Dowex 50W-X8 cation exchange columns with HBr.

HBr Concn., M	Hg <sup>+2</sup>		Bi <sup>+3</sup>		Cd <sup>+2</sup>		Pb <sup>+2</sup>	
	Break- through, ml. HBr	Elution complete	Break- through, ml. HBr	Elution complete	Break- through, ml. HBr	Elution complete	Break- through, ml. HBr	Elution complete
0.1	0-10	60	80	220	>200	...	...	...
0.2	0-10	60	20	120	160	380	...	...
0.3	0-10	40	0-10	60	80	>200	>200	...
0.4	...	...	0-10	60	20	120	180	>200
0.5	0-10	40	0-10	60	20	100	100	240
0.6	0-10	20	0-10	40	0-10	80	60	240
							40 <sup>a</sup>	140 <sup>a</sup>

<sup>a</sup> Excess lead precipitated with HBr prior to column loading.

See page 201 for copyright citation.

mercury belongs to the latter group. The elution behavior of some metal ions can be changed by varying the concentration of the hydrofluoric acid eluent, as shown in Table XXI.

Table XXI. Elution of metal ions from a 12 x 60 mm cation exchange column.

Metal Ion	H <sup>+</sup> Form Resin			
	0.1M HF, Ml.		1.0M HF, Ml.	
	Break- through	Elution complete	Break- through	Elution complete
Ag	>200	...	>200	...
Al	0-20	160	0-20	60
As(III)	0-20	>200	0-20	100
Ba	>200	...	0-20	160
Be	>200	...	>200	...
Bi	>200	...	40-60	>200
Ca	>200	...	0-20	>200
Cd	0-20	180	0-20	80
Co(II)	>200	...	>200	...
Cr(III)	>200	...	>200	...
Cu(II)	>200	...	>200	...
Fe(II)	>200	...	180-200	240
Fe(III)	>200	...	0-20	160
Ga	>200	...	0-20	160
Hg(II)	>200	...	40-60	160
In	>200	...	>200	...
La	>200	...	>200	...
Mg	>200	...	>200	...
Mn(II)	180-200	>200	0-20	60
Mo(VI)	0-20	40	0-20	...
Nb	0-20	40	0-20	...
Ni	>200	...	>200	...
Pb(II)	>200	...	100-120	>200
Sb(III)	20-40	>200	0-20	100
Sc	0-20	80	...	...
Sn(IV)	0-20	60	...	...
Sr	>200	...	0-20	160
Ta	0-20	40	...	...
Th	>200	...	>200	...
Ti(IV)	0-20	80	...	...
U(VI)	0-20	180	0-20	100
V(V)	>200	...	0-20	120
W(VI)	0-20	60	...	...
Y	>200	...	>200	...
Zn	>200	...	0-20	100
Zr	0-20	140	0-20	100

See page 201 for copyright citation.

### i. Cation Exchange of Mercury in the Thiocyanate System

Mercuric ions are weakly adsorbed on a certain exchanger such as Amberlite IR-120 in the thiocyanate form.<sup>124</sup> For example, 50 millimoles of Hg could be eluted quantitatively from a 40-60 mesh column, 13 mm wide and 160 mm long, with 150 ml of 0.5 percent thiocyanate solution. An application of this behavior for rapid mercury separations is suggested in Figure 26.<sup>124</sup>

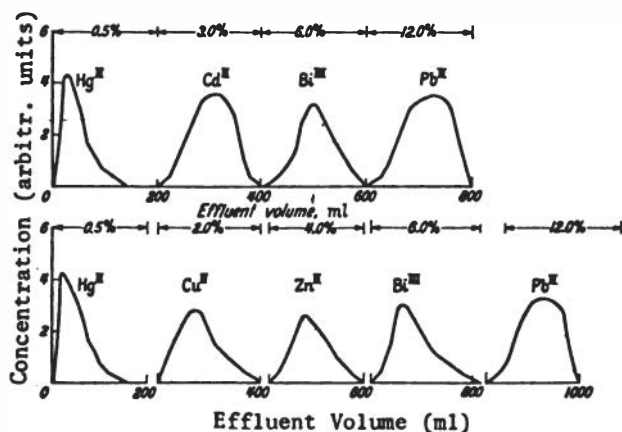

Figure 26. Elution of several cations with thiocyanate.

In contrast to the behavior on a cation exchanger in the thiocyanate form, mercury forms readily  $\text{Hg}(\text{SCN})_4^{--}$  complexes with an excess of thiocyanate ion. This complex is strongly adsorbed on an anion exchanger such as Amberlite IRA-400<sup>124</sup>, a behavior which could be utilized to retain mercury on a column and thus separating it from other ions.

### j. Cation Exchange of Mercury in the Sulfate System

Information on the cation exchange behavior of mercury, in fact of most elements, is scarce. Strelow<sup>125</sup> has measured cation exchange equilibrium coefficients with Bio-Rad Ag 50W-X8, 100-200 mesh, from 0.1 N to 4.0 N sulfuric acid at a total amount of cation to total resin capacity ratio  $q = 0.4$ . Since systematically compiled data on distribution coefficients

are useful to the radiochemist for planning separations, Strelow's data are reproduced in Table XXII.

Table XXII. Summary of some equilibrium distribution coefficients.

Cation	0.1N	0.2N	0.5N	1.0N	2.0N	3.0N	4.0N
La(III)	>10 <sup>4</sup>	>10 <sup>4</sup>	1860	329	68	24.3	12.1
Ce(III)	>10 <sup>4</sup>	>10 <sup>4</sup>	1800	318	66	23.8	11.8
Sm(III)	>10 <sup>4</sup>	>10 <sup>4</sup>	1460	269	56	20.1	10.0
Y(III)	>10 <sup>4</sup>	>10 <sup>4</sup>	1380	253	49.9	18.0	9.4
Yb(III)	>10 <sup>4</sup>	>10 <sup>4</sup>	1330	249	48.1	17.3	8.8
Gd(III)	>10 <sup>4</sup>	>10 <sup>4</sup>	1390	246	46.6	17.9	8.9
Er(III)	>10 <sup>4</sup>	>10 <sup>4</sup>	1300	242	48.6	16.7	8.5
Bi(III) <sup>a</sup>	>10 <sup>4</sup>	>10 <sup>4</sup>	6800	235	32.3	11.3	6.4
Ga(III)	>10 <sup>4</sup>	3500	618	137	26.7	10.0	4.9
Al(III)	>10 <sup>4</sup>	8300	540	126	27.9	10.6	4.7
Hg(II)	7900	1790	321	103	34.7	16.8	12.2
In(III)	>10 <sup>4</sup>	3190	376	87	17.2	6.5	3.8
Mn(II)	1590	610	165	59	17.4	8.9	5.5
Fe(III)	>10 <sup>4</sup>	2050	255	58	13.5	4.6	1.8
Cr(III)	198	176	126	55	18.7	0.9	0.2
Th(IV)	>10 <sup>4</sup>	3900	263	52	9.0	3.0	1.8
Tl(I)	452	236	97	49.7	20.6	11.6	8.7
Tl(III)	6500	1490	205	47.4	12.0	7.2	5.2
V(IV)	1230	490	140	46.6	11.5	2.4	0.4
Ni(II)	1390	590	140	46.0	16.5	6.1	2.8
Fe(II)	1600	560	139	46.0	15.3	9.8	6.6
Cd(II)	1420	540	144	45.6	14.8	6.6	4.3
Zn(II)	1570	550	135	43.2	12.2	4.9	4.0
Co(II)	1170	433	126	42.9	14.2	6.2	5.4
Cu(II)	1310	505	128	41.5	13.2	5.7	3.7
Mg(II)	1300	484	124	41.5	13.0	5.6	3.4
Sc(III)	5600	1050	141	34.9	8.5	4.4	3.4
Be(II)	840	305	79	27.0	8.2	3.9	2.6
Cs(I)	175	108	52	24.7	9.1	4.8	3.5
Rb(I)	148	91	43.8	21.3	8.3	4.4	3.1
K(I)	138	86	41.1	19.4	7.4	3.7	2.9
Rh(III)	80	49.3	28.5	16.2	4.5	2.2	1.3
Pd(II)	109	71	32.5	13.9	6.0	3.8	2.7
Hf(IV)	2690	1240	160	12.1	1.7	1.0	0.7
U(VI)	596	118	29.2	9.6	3.2	2.3	1.8
Ti(IV)	395	225	45.8	9.0	2.5	1.0	0.4
Na(I)	81	47.7	20.1	8.9	3.7	2.6	1.7
Li(I)	48.0	28.2	11.7	5.8	3.0	1.6	1.1
Te(IV)	Ppt.	30.8	9.8	5.2	2.6	0.6	0.3
Zr(IV)	546	474	98	4.6	1.4	1.2	1.0
V(V)	27.1	15.2	6.7	2.8	1.2	0.7	0.4
Nb(V)	14.2	7.4	4.0	1.9	0.7	0.5	0.3
Mo(VI)	Ppt.	5.3	2.8	1.2	0.5	0.3	0.2
Sc(IV)	<0.5	<0.5	<0.5	<0.5	<0.5	<0.5	<0.5
As(III)	<0.1	<0.1	<0.1	<0.1	<0.1	<0.1	<0.1

<sup>a</sup> Determined for  $q = 0.06$  because of limited solubility.

See page 201 for copyright citation.

#### k. Cation Exchange Behavior of Mercury on Inorganic Ion Exchangers from Nitrate Solutions

Recently four inorganic compounds, hydrous zirconium oxide, zirconium molybdate, zirconium phosphate, and zirconium tungstate, have become commercially available as ion exchangers. The latter three compounds are sufficiently acidic to act only as cation exchangers. In acid solution, i.e., at pH levels below the isoelectric point, the positively charged polymer is electrically neutralized by exchangeable anions, thus acts as an anion exchanger. At pH levels above the isoelectric point, the hydrous zirconium oxide polymer is negatively charged and is electrically neutralized

with exchangeable cations. In Figures 27, 28, 29, and 30 the exchange characteristics are summarized of some 60 elements on hydrous zirconium oxide, zirconium molybdate, zirconium phosphate, and zirconium tungstate, respectively.<sup>126</sup> For organic ion exchangers, the adsorption behavior of a given element is usually reported in terms of a distribution coefficient as a function of the acid molarity of the solution containing that particular ion. The same notation was used to describe the behavior of inorganic ion exchangers.

In Figures 27 through 30 the distribution coefficient is defined as the amount of metal ion adsorbed per gm of exchanger/amount of metal ion per milliliter of contacting solution. The exchange behavior of mercury (II) was studied up to a pH of -3 on all four exchangers, because of precipitation of basic salts at higher pH values.

The mechanism of retention of ions from nitric acid solutions on specifically prepared  $\text{MnO}_2$  columns<sup>127</sup> is probably a combination of ion exchange and adsorption-desorption processes. The results of a study on the adsorption of some sixty elements on  $\text{MnO}_2$ , presented in Figure 31, was reported using ion-exchange terminology, i.e., distribution coefficient as a function of acid molarity.

For the purpose of this monograph,  $\text{MnO}_2$  is considered an 'inorganic' ion exchanger. It should be noted that the dependence of the distribution coefficient on acid molarity shows only two types of variation: decreasing or increasing with increasing acidity, never exhibiting an adsorption peak at a particular acid normality. Also, no definite trend in adsorption behavior is evident among elements of similar chemical behavior.

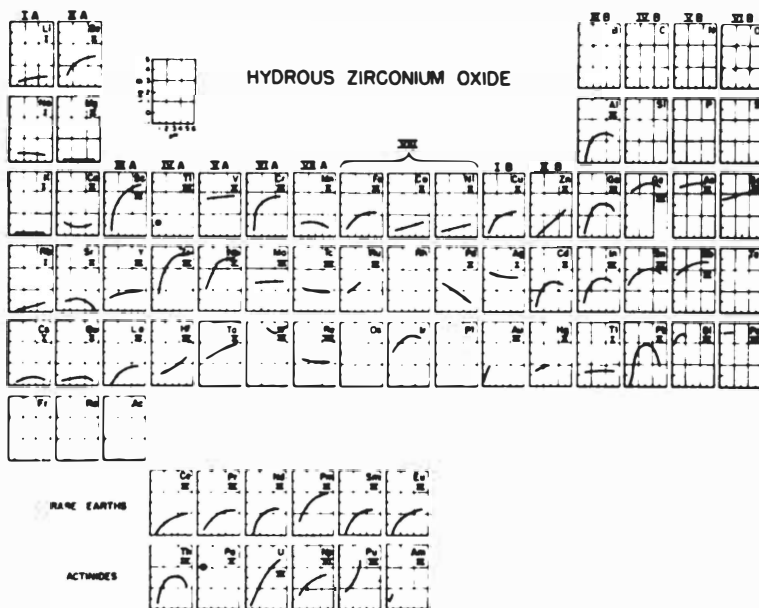

**Figure 27. Exchange characteristics of elements on hydrous zirconium oxide.**

See page 201 for copyright citation.

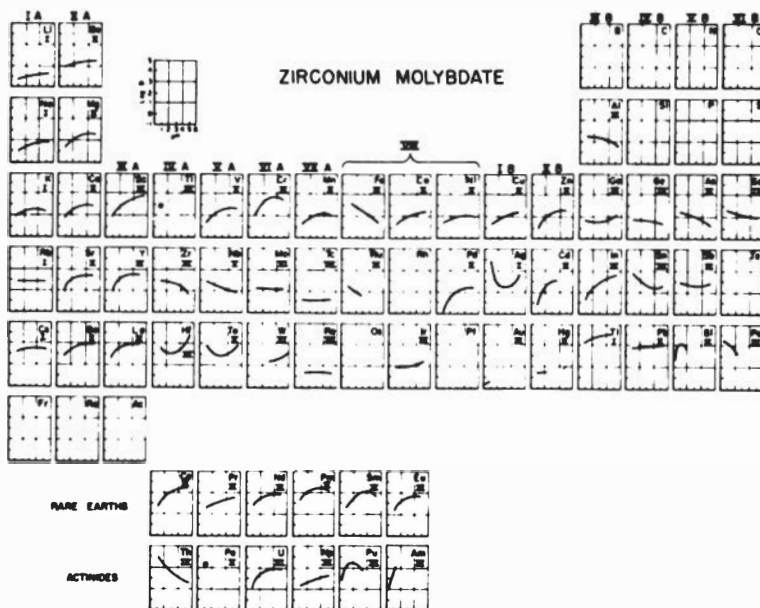

**Figure 28. Exchange characteristics of elements on zirconium molybdate.**

See page 201 for copyright citation.



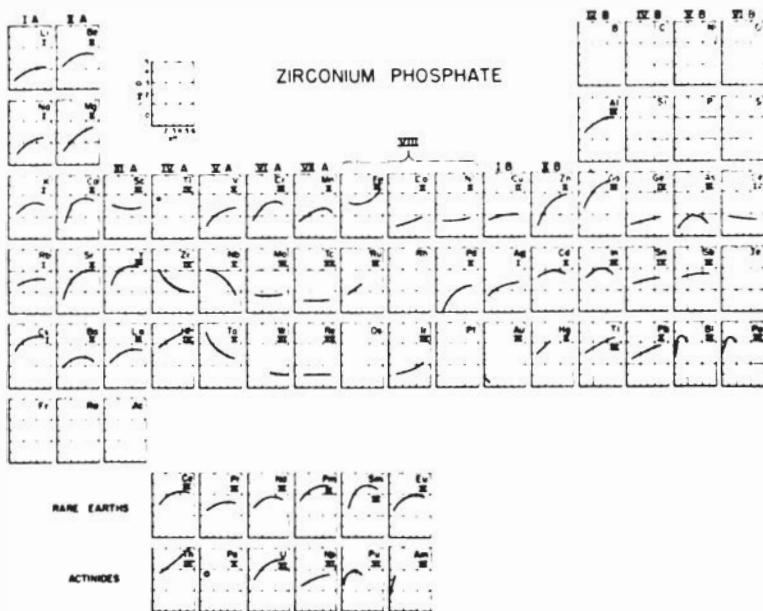

Figure 29. Exchange characteristics of elements on zirconium phosphate.

See page 201 for copyright citation.

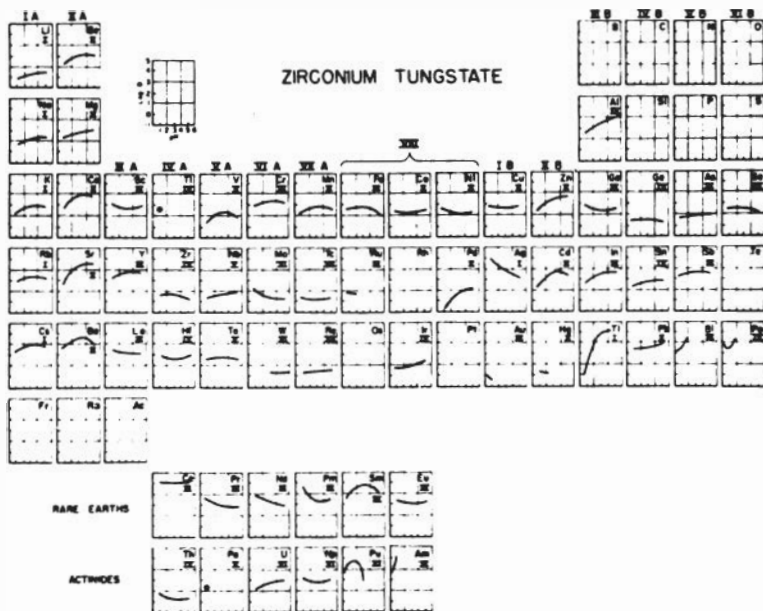

Figure 30. Exchange characteristics of elements on zirconium tungstate. (M-8).

See page 201 for copyright citation.

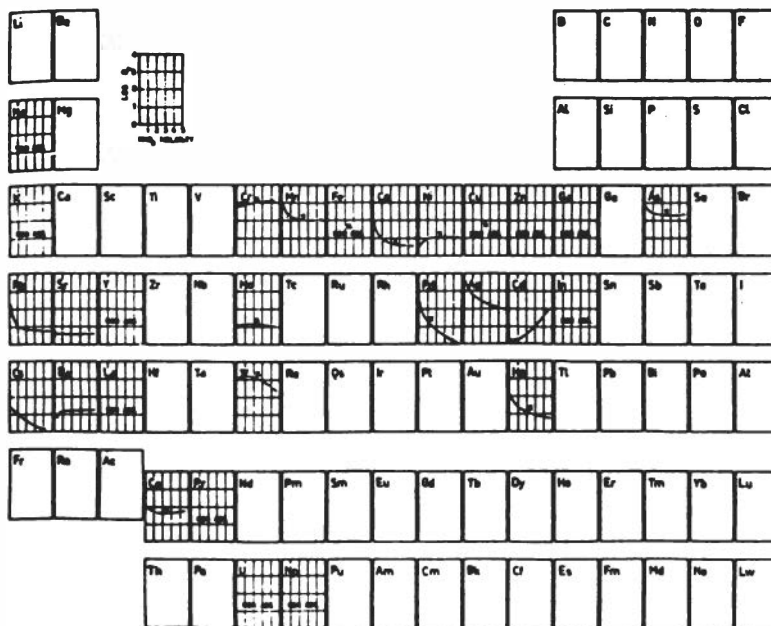

Figure 31. Adsorption of elements from nitric acid solutions on  $MnO_2$ .  
See page 201 for copyright citation.

### 1. Mercury-Specific Ion Exchangers

Specificity for a certain ion in an ion exchanger can be achieved by incorporating into the resin matrix a group or reagent specific for that ion. The preparation and performance of several ion exchangers specific for mercury but containing different mercury-selective groups have been described.

Resins which contain mercapto groups,  $R-S-H$ , such as polythiolstyrene, are highly specific for elements which form mercaptides, particularly for mercuric ions.<sup>128,129</sup>

Ion exchangers which contain maleinyl hydrazide are specific for mercury in slightly acid ( $pH \sim 1$ ) solutions.<sup>130</sup> Cyclic maleinyl hydrazide

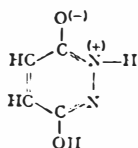

is a weak monobasic acid with a  $pK = 5.58$  which forms slightly soluble salts with cations such as  $Ag^+$ ,  $Hg_2^{2+}$ ,  $Hg^{2+}$ , and  $Tl^+$ . The condensation of resorcinol with formaldehyde in the presence of maleinyl hydrazide leads to a mercury-specific ion exchanger<sup>130</sup> of the structure:

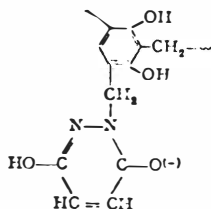

The ions  $Hg_2^{++}$  and  $Hg^{++}$  are quantitatively removed from acid solution (pH 1) when passed over this resin and cannot be eluted with 2 percent acetic acid. However, elution with 1 N  $HClO_4$  removes the mercury from the resin. Below is a procedure for the preparation of this resin:

#### Preparation of Maleinyl Hydrazide Ion Exchange Resin

Solutions of 0.2 moles of resorcinol (22 g) in 40 ml of water, 0.1 mole (11 g) of maleinyl hydrazide and 0.1 mole (0.4 g) of NaOH in 60 ml of water are thoroughly mixed. The resulting solution should be made alkaline by further addition of NaOH, if necessary. After adding 70 ml of a 35 percent solution of formalin in water, the mixture is warmed in a covered porcelain dish on a water bath. Very soon a clear gel is being formed which solidifies after 20-30 hours to a reddish-brown brittle resin which can easily be ground. Before use, the resin should be washed alternately with dilute HCl and NaOH to remove uncondensed reactants. The resin is not stable even toward dilute  $HNO_3$ .

Another ion exchanger which contains dimethyl-aminobenzylidene-rhodamine as the mercury-specific group has been described by Lewandowski and Szczepaniak.<sup>131</sup> Then authors also published a detailed procedure for its preparation.<sup>132</sup> In addition to  $Hg^{+2}$ , this ion exchanger adsorbs strongly  $Ag^+$ ,  $Cu_2^{+2}$ ,  $Au^{+3}$ ,  $Pd^{+2}$ ,  $Pt^{+4}$ , and  $Os^{+8}$ . To elute these ions the following solutions are required:  $Cu_2^{+2}$  is removed with 200 ml of 1 N  $H_2SO_4$ ,  $H_2OsO_4$

with 50 ml of 1.5 N HCl,  $\text{Hg}^{+2}$  with 200 ml of 2 N  $\text{HNO}_3$  (2 ml/min), Ag with 100 ml of 0.2 N  $\text{Na}_2\text{S}_2\text{O}_3$  (in 5 percent  $\text{Na}_2\text{CO}_3$  solution), and  $\text{Pd}^{+2}$ ,  $\text{Pt}^{+4}$ , and  $\text{Au}^{+3}$  together with 150 ml 3 N HCl.

#### 11. Chromatographic Behavior of Mercury

For a thorough review of inorganic chromatography, the reader is referred to a paper by Wells<sup>133</sup> and also to an article by Weil<sup>134</sup> which deals exclusively with paper chromatography. Advantages of chromatography over many conventional separation techniques are the exceptionally high decontamination factors that can be achieved, the method is generally less laborious, and a particular element, by choosing the proper conditions, can be separated carrier-free from all others present in a single step.

In the following, no attempt was made to categorize the various separation methods for mercury. The inclusion of a particular method in this section was based entirely on speed and completeness of separation.

In a brief note, Tewari<sup>135</sup> discusses a paper chromatographic technique for the separation of mixtures of ions such as Cu-Pb-Hg(II)-As-Sb-Sn, or Hg(I)-Pb-Ag or Cu-Co-Ni. His method consists in using the ascending technique of solvent flow on a paper strip, with a modification of fixing several horizontal strips at equal distant places from the bottom. The mixture of ions, on meeting the first horizontal strip, separates into its components, all of the different ions being chromatographed on both sides of the horizontal strip. The solvent front, on moving further up, meets another horizontal strip, fixing a few more ions. When the solvent front has crossed all the horizontal strips, the strips are dried and sprayed with a suitable reagent. All ions of the mixture are chromatographed on the first (from the bottom) strip. The number of ions chromatographed becomes less and less in successive strips, so much so, that the last strip contains only one ion. The  $R_f$  values, the ratio of the distance of the leading edge of a zone to the distance of the solvent front, both measured from the midpoint of

the original spot, which were determined by this method, were in accord with those obtained by other methods.

In attempts to discover yet unknown radioactive nuclides in the region around 126 neutrons, Warren<sup>136</sup> devised a method for separating microgram quantities of Hg, Tl, Bi, Pb, Pt, Au, Cu, Ni, Co, Fe, Cd, and Pd in 2 to 20 minutes by ascending paper chromatography. His technique involves the use of thick absorbent paper, having high wettability, a developer of high wetting power, and an atmosphere which is supersaturated with vapors of the solvent. This procedure is reproduced in its entirety as Procedure 19 in Chapter VI. Warren's method of separating mercury and gold from Ra DEF on a cellulose column<sup>137</sup> is presented as Procedure 18 in Chapter VI.

Systematic data on the chromatographic behavior of metal ions toward various developers and different types of paper have been published by Lederer and co-workers.<sup>138,139</sup> Some pertinent results are presented in Figures 32<sup>138</sup> and 33.<sup>139</sup>

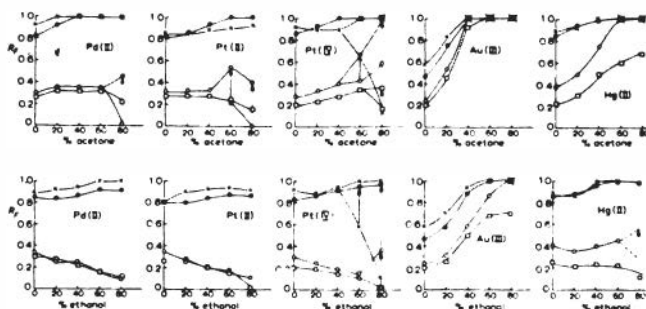

Figure 32.  $R_f$  values on some anionic chloro-complexes on various cellulose exchangers with acetone-2N HCl and ethanol-2N HCl mixtures. (□) Diethylamino ethyl cellulose, (○) Aminoethyl cellulose, (●) Whatman No. 1, (X) Cellulose phosphate)

Related both to ion-exchange and to liquid-liquid extraction is the so-called "reversed-phase partition chromatography". The term reversed phase arises because of the convention, particularly in paper chromatography, of regarding the organic phase as the mobile phase. O'Laughlin and Banks<sup>140</sup> investigated the use of the neutral organophosphorous compounds tri-n-butyl phosphate (TBP), tri-n-octylphosphine oxide (TOPO), and bis(di-n-hexyl-

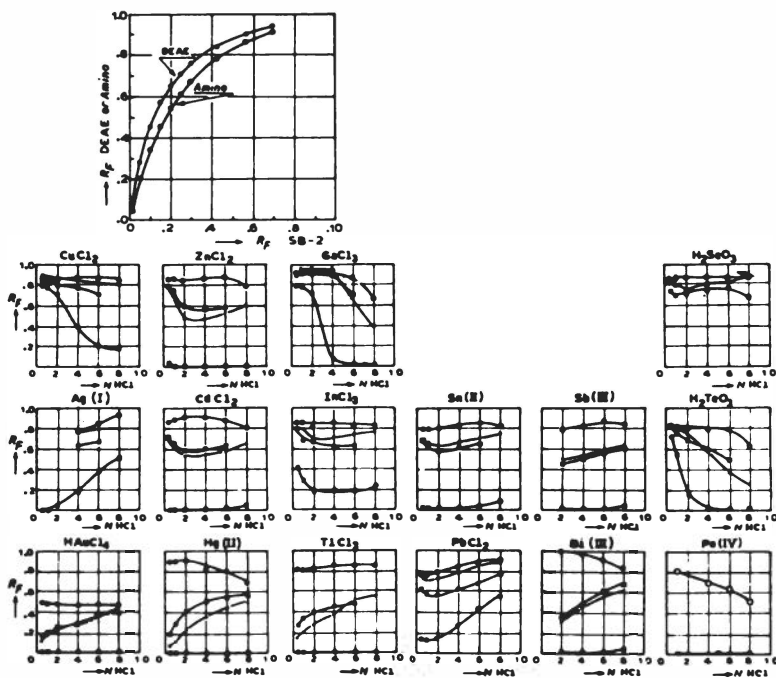

Figure 33.  $R_F$  values of metal ions on Whatman No. 1 paper ( $\circ$ — $\circ$ ), Sb-2 resin paper ( $\blacksquare$ — $\blacksquare$ ), DE-20 cellulose anion-exchange paper ( $\bullet$ — $\bullet$ ), and AE-30 cellulose anion-exchange paper ( $\square$ — $\square$ ) are plotted against the concentration of HCl. With the exception of Pt(II) which was placed below Pt(IV) the metal ions placed in their positions in the periodic table.

phosphinyl)methane (HDPM) as the stationary phases in the reversed-phase partition chromatography of various metal chlorides, nitrates, and perchlorates. The high partition coefficients of many metal salts make above compounds particularly useful for reversed-phase paper chromatography. The small amounts ( $\sim 10^{-6}$  mole/cm<sup>2</sup>) of the organophosphorous compounds required on the paper and the fact that their melting points are low enough so that they do not crystallize on the paper are advantages. The capillary flow of solvent over the paper appeared not to be affected by treating the paper with TBP, TOPO, or HDPM. Summaries of  $R_F$ -values for metal nitrates, chlorides, and perchlorates as a function of acid concentration on paper treated with TBP, TOPO, and HDPM are given in Tables XXIII, XXIV, and XXV, respectively. No special equipment or the use of volatile or noxious solvents is required in achieving otherwise difficult separations by reversed-phase partition chromatography.

Table XXIII.  $R_f$  values for metal nitrates as function of nitric acid concentration on TBP-, TOPO-, and HDPM-treated papers.

Element	TBP Acid molarity					TOPO Acid molarity					HDPM Acid molarity				
	0.5M	3M	6M	9M	12M	0.5M	3M	6M	9M	12M	0.5M	3M	6M	9M	12M
Sc	1.0	0.69	0.59	0.79	1.0	0.01	0.03	0.07	0.11	0.44	0.01	0	0	0.05	0.03
Y	1.0	0.90	0.76	1.0	1.0	0.11	0.67	0.92	1.0	1.0	0.02	0.09	0.13	0.43	0.83
La	1.0	1.0	0.94	1.0	1.0	0.95	1.0	1.0	1.0	1.0	0.02	0.30	1.0	1.0	1.0
Eu	1.0	0.92	0.96	1.0	1.0	0.11	0.84	1.0	1.0	1.0	0.02	0.08	0.27	0.68	1.0
Gd	1.0	0.92	0.94	1.0	1.0	0.11	0.84	1.0	1.0	1.0	0.02	0.09	0.29	0.71	1.0
Tb	1.0	0.89	0.92	1.0	1.0	0.08	0.85	1.0	1.0	1.0	0.02	0.08	0.22	0.59	1.0
Lu	1.0	0.84	0.71	0.91	1.0	0.07	0.48	0.87	1.0	1.0	0.03	0.06	0.06	0.14	0.38
Th	0.54	0.06	0.10	0.36	1.0 <sup>b</sup>	0	0	0.02	0	0.16	0	0	0	0	0.05
U(VI)	0.32	0.05	0.07	0.82	1.0	0	0	0.0	0	0.10	0	0	0	0	0.03
Zr	0.92 <sup>a</sup>	0.19	0.06	0.07	0.44 <sup>a</sup>	0	0	0.01	0	0	0	0	0	0	0.02
Cr(III)	1.0	1.0	1.0	...	...	1.0	1.0	1.0	...	...	1.0	1.0	1.0	...	...
Mn(II)	1.0	1.0	1.0	...	...	0.98	1.0	1.0	...	...	0.56	1.0	1.0	...	...
Fe(III)	1.0	0.95	0.89	1.0	1.0	0.89 <sup>a</sup>	0.64 <sup>a</sup>	0.54 <sup>a</sup>	1.0	1.0	0	0	0	...	0.05
Co(II)	1.0	1.0	1.0	...	...	1.0	1.0	1.0	...	...	1.0	1.0	1.0	...	...
Ni(II)	1.0	1.0	1.0	...	...	1.0	1.0	1.0	...	...	1.0	1.0	1.0	...	...
Cu(II)	1.0	1.0	1.0	...	...	1.0	1.0	1.0	...	...	1.0	1.0	1.0	...	...
Ag	1.0	0.11 <sup>a</sup>	0.08 <sup>a</sup>	0	0	0.17 <sup>a</sup>	0.15 <sup>a</sup>	0.07 <sup>a</sup>	0	0	0.28 <sup>a</sup>	0.1 <sup>c</sup>	0.11 <sup>a</sup>	0	0
Zn	1.0	1.0	1.0	...	...	1.0	1.0	1.0	...	...	1.0	1.0	1.0	...	...
Cd	1.0	1.0	1.0	...	...	1.0	1.0	1.0	...	...	0.84 <sup>a</sup>	1.0	0.86	...	...
Hg(II)	1.0	0.10	0.10 <sup>a</sup>	0?	1.0	1.0	0.03	0.14 <sup>a</sup>	1.0	1.0	0.22	0	0.2 <sup>a</sup>	1.0	1.0
Al	1.0	1.0	1.0	1.0	1.0	1.0	1.0	1.0	1.0	1.0	? <sup>c</sup>	? <sup>c</sup>	? <sup>c</sup>	0 <sup>c</sup>	0.07 <sup>c</sup>
Pb(II)	1.0	1.0	1.0	...	...	0.96	0.89	0.97	...	...	0.94	1.0	1.0	...	...
Bi	0.79	0.95	1.0	1.0	1.0	0.01	0.60	0.94	1.0	1.0	0	0.02	0.60	1.0	1.0

<sup>a</sup> Tailed.<sup>b</sup> Some Th at start line and some at solvent front.<sup>c</sup> Tailed badly, in the case of Al with HDPM from start line to solvent front but with 12M HNO<sub>3</sub> most Al remained at start line.

See page 201 for copyright citation.

Table XXIV.  $R_f$  values for metal chlorides as function of hydrochloric acid concentration on TBP-, TOPO-, and HDPM-treated papers.

Element	TBP					TOPO					HDPM				
	Acid concentration					Acid concentration					Acid concentration				
	0.5M	3M	6M	9M	12M	0.5M	3M	6M	9M	12M	0.5M	3M	6M	9M	12M
Zn	0.43	0.39	0.50	0.77	0.72	0.05	0.01	0	0.09	0.13	0.02	0.01	0.01	0.35	0.27
Cd	0.52	0.26	0.37	0.81	0.75	0.05	0	0	0.16	0.18	0.02	0.01	0.05	0.21	0.19
Al	1.0	1.0	1.0	1.0	0.82	1.0	1.0	0.86	1.0	1.0	1.0	0.92	0.87	?	0.95 <sup>a</sup>
Ga	0.37	0.03	0	0	0	0.11	0	0	0	0	0.66	0	0	0	0
In	0.48	0.08	0.13	0.20	0.44	0.05	0.01	0.02	0.14	0.14	0	0.02	0.03	0.67	0.53
Sc	0.95	0.90	...	0.28	0.10	0.07	0.02	...	0.03	0.04	0.05	0	...	0.02	0
Y	0.95	0.90	0.85	1.0	0.82	1.0	1.0	0.97	1.0	1.0	0.79	0.80	0.92	0.65	0.71
Ti	0.95	0.94	0.95	1.0	0.47	0.28	0.10	0.02	0.03	0	0.11	0.04	0.02	0	0
Sn(II)	0.1	0.03	0	0	0.19	0	0	0	0	0	0	0	0	0	0
Mo(VI)	0.47	0.02	0	0	0.07	0	0	0	0	0.05	0	0	0	0	0
Nb(V)	0.1	0.04	0	0	0	0	0	0	0	0	0	0	0	0	0
Mn(II)	0.95	0.97	0.91	1.0	1?	0.92	0.75	0.49	1.0	...	0.90	0.93	0.78	1.0	0.90
Fe(III)	0.47	0.02	0	0	0	0.03	0	0	0	0	0.08	0	0	0	0
Co	0.95	0.96	0.89	1.0	0.72	0.84	0.20	0.07	0.28	0.13	0.92	0.89	0.17	0.64	0.34
Ni	0.95	0.96	0.89	1.0	0.75	0.98	0.97	0.84	1.0	0.80	0.96	0.98	0.86	1.0	0.94
Cu	0.94	0.83	0.83	1.0	0.75	0.78	0.10	0.05	0.77	0.43	0.76	0.65	0.44	0.93	0.70
V(IV)	0.95	0.88	0.92	1.0	0.75	0.92	0.88	0.77	0.87	0.7	0.60	0.39	0.21	0.43	0.40 <sup>a</sup>
Cr(III)	1.0	0.91	0.91	1.0	1.0	1.0	0.98	0.77	1.0	0.7	1.0	1.0	1.0	1.0	0.97
Zr	0.95	0.87	0.88	0	0	0.02	0	0	0	0	0.02	0	0	0	0
Hf	0.95	0.87	0.89	0.21	0	0.04	0	0	0	0	0.04	0	0	0	0
U(VI)	1.0	0.12	...	0	...	0.04	0	...	0	...	0	0	0	0	0
Th	0.95	0.84	...	0.54	...	0.08	0.07	...	0.04	...	0	0.01	0	0	0
Hg(II)	0.13	0.08	0	0.64	0	0	0	0	0.06	0.06	0	0.02	0.06	0.11	0.12
Au	0	0.02	0	0	0	0	0	0	0	0	0	0	0	0	0
Pt	0	0.01	0	?	?	0	0	0	0.06	0.05	0.02	0.02	0.04	0.12	0.17

<sup>a</sup> Tailed.

See page 201 for copyright citation.



Table XXV.  $R_F$  values for metal perchlorates on TBP-, TOPO-, and HDPM-treated papers.

Element	0.5M HClO <sub>4</sub>			3.0M HClO <sub>4</sub>		
	TBP	TOPO	HDPM	TBP	TOPO	HDPM
Be	1.0	1.0	0.32 <sup>a</sup>	1.0	1.0	0.34 <sup>a</sup>
Zn	0.78	1.0	0.72	1.0	1.0	0.92
Cd	0.90	1.0	0.06	1.0	0.88	0.86
Hg	0.51	0.70	0.59	0.64	0.66	0.69
Al	1.0	1.0	1.0 <sup>a</sup>	1.0	1.0	1.0 <sup>2</sup>
In	0.89	0.11	0	0.88	0.79	0
Tl(I)	0	0	0	0	0	0
Pb(II)	0.64	0.82	0.14	0.44	0.44	0.38
Mn	0.94	1.0	0.04	1.0	1.0	0.84
Fe(III)	0.93	0	0	0.94	?	?
Co	0.94	1.0	0.92	1.0	1.0	0.93
Ni	0.94	1.0	1.0	1.0	1.0	1.0
Cu	0.93	1.0	0.87	1.0	1.0	0.87
U(VI)	0.71	0	0	0.41	0.06	0
Th	0.95	0.10	0	0.83	0.23	0
Y	0.95	1.0	0	1.0	1.0	0
Sc	0.77	0	0	0.27	0.04	0
Ce(III)	0.92	1.0	0	1.0	1.0	0
La	0.91	1.0	0	1.0	1.0	0
Tb	0.90	1.0	0	1.0	1.0	0
Gd	0.90	1.0	0	1.0	1.0	0
Tm	0.89	1.0	0	1.0	1.0	0
Lu	0.89	1.0	0	1.0	1.0	0
Acid Front	0.92	1.0	0.97	1.0	1.0	1.0

<sup>a</sup> Tailed, in case of Al from  $R_F = 0$  to 1.

See page 201 for copyright citation.

A study to survey the technique of electrochromatography, sometimes called electromigration, with a view of applying it to radiochemical analyses, particularly of ions of adjacent atomic number showed that the major advantage over other means of separation is speed.<sup>141,142</sup> Disadvantages are the necessity of providing some means of cooling the paper in which the migration of ions takes place, and occasional charring of the paper due to arcing from the electrodes. At present, electrochromatography is not developed far enough to offer real advantages over other methods of separating mercury

## 12. Volatilization Analysis for Mercury

The observation that some metal salts volatilize when boiled in acid solution led to the development of a separation technique based on the

increased vapor pressure of substances at elevated temperatures. One of the first systematic studies of the volatilization of elements from boiling acidic solutions was carried out by Hoffman and Lundell.<sup>143</sup> Some of the results of this investigation are summarized in Table XXVI. It appears that mercurous and mercuric chloride in oxidizing acids should not be boiled for any length of time because of the appreciable volatilization of  $\text{HgCl}_2$ .

Like other techniques in analytical chemistry, vaporization analysis has been refined to a point where it is applicable to trace analysis. Geilmann<sup>144</sup> describes equipment, procedures, and applications of vaporization analysis to determine trace metals in amounts as little as  $10^{-9}$  grams.

Coprecipitation of mercury with a non-isotopic, non-radioactive carrier, copper, and volatilization were utilized by Bielfeldt and Gänssle<sup>28</sup> to determine mercury traces in commercial hydrochloric acid. Mercury was first

TABLE XXVI. Volatilization of elements from acid solutions at 200 to 220 °C.

Element	Approximate percentage volatilized from 20-100 mg portions by distillation with					
	HCl-HClO <sub>4</sub>	HBr-HClO <sub>4</sub>	HCl-H <sub>3</sub> PO <sub>4</sub> -HClO <sub>4</sub>	HBr-H <sub>3</sub> PO <sub>4</sub> -HClO <sub>4</sub>	HCl-H <sub>2</sub> SO <sub>4</sub>	HCl-H <sub>2</sub> SO <sub>4</sub>
As(III)	30	100	30	100	100	100
As(V)	5	100	5	100	5	100
Au	1	0.5	0.5	0.5	0.5	0.5
B	20	20	10	10	50	10
Bi	0.1	1	0	1	0	1
Cr(III)	99.7	40	99.8	40	0	0
Ge	50	70	10	90	90	95
Hg(I)	75	75	75	75	75	90
Hg(II)	75	75	75	75	75	90
Mn	0.1	0.02	0.02	0.02	0.02	0.02
Os	100	100	100	100	0	0
P	1	1	1	1	1	1
Re	100	100	80	100	90	100
Ru	99.5	100	100	100	0	0
Sb(III)	2	99.8	2	99.8	32	99.8
Sb(V)	2	99.8	0	99.8	2	98
Se(IV)	4	2 to 5	2 to 5	2 to 5	30	100
Se(VI)	4	5	5	5	20	100
Sn(II)	99.8	100	0	99.8	1	100
Sn(IV)	100	100	0	100	30	100
Te(IV)	0.5	0.5	0.1	0.5	0.1	10
Te(VI)	0.1	0.5	0.1	1	0.1	10
Tl(I)	1	1	1	1	0.1	1
V(V)	0.5	2	0	0	0	0

coprecipitated with CuS. The CuS (HgS) was dissolved in chlorine water and mercury was electrodeposited on a copper spiral. Finally, the mercury was distilled from the copper cathode into a quartz capillary where it formed a tiny sphere. Its weight was calculated after measuring its diameter under a microscope.

Radioactive isotopes of mercury, platinum, iridium, osmium, and rhenium, formed by 150-MeV proton spallation of gold, were separated from each other by volatilization in streams of argon and chlorine in a 90 cm long and 1.5 cm diameter copper tube along which a temperature gradient was maintained.<sup>145</sup> This method appears quite adaptable for the separation and purification of some radioactive isotopes in tracer quantities.

Very similar, rapid methods for the carrier-free separation of mercury activities, but operating at reduced pressures<sup>146</sup> or in a vacuum<sup>147,148</sup> have also been reported.

Determination of mercury in larger than trace quantities by volatilization and subsequent amalgam formation have been described by Consalvo<sup>149</sup> and Majer.<sup>150</sup> Reaser and co-workers<sup>151</sup> volatilized the mercury activities from a mixture of Na<sup>22</sup> and Hg<sup>203,205</sup> in certain pharmaceutical preparations. By counting before and after volatilization, they were able to measure the Na<sup>22</sup> content directly, and the mercury activity by difference.

The reader is referred to DeVoe's monograph<sup>152</sup> for more specific information regarding the separation of radioactive elements by volatilization. Several Procedures in Chapter VI are based on the volatility of mercury at elevated temperatures.

## IV. NUCLEAR METHODS OF MERCURY ANALYSIS

## 1. Activation Analysis of Mercury

## a. Thermal Neutron Activation

When mercury of natural isotopic composition is irradiated with neutrons of thermal energies, each of the six stable mercury isotopes undergoes radiative capture reactions independently of each other. The pertinent nuclear data for the  $(n,\gamma)$  reactions leading to radioactive products are summarized in Table XXVII.<sup>153</sup>

TABLE XXVII. Nuclear data for thermal neutron activation analysis of mercury.

Target Nuclide	Abundance (percent)	Isotopic Activation Cross Section (barns)	Product Radio-nuclide on Thermal Neutron Irradiation	Radiation and Energy (MeV)	Half-life
Hg <sup>196</sup>	0.146	420	Hg <sup>197m</sup>	IT (96.5%) e <sup>-</sup> $\gamma_1$ 0.134 (51%) $\gamma_2$ 0.165 (0.28%) 0.071 - Hg Xray EC (3.5%) via 7.2s Au <sup>197m</sup> e <sup>-</sup> $\gamma_1$ , 0.130 (7%) $\gamma_2$ , 0.279 (74%) $\gamma_3$ , 0.407 (0.3%)	24 h
		880	Hg <sup>197</sup>	EC (100%) e <sup>-</sup> $\gamma_1$ 0.0773 (23%) $\gamma_2$ 0.191 (5%) 0.068 - Au Xray	65 h
Hg <sup>198</sup>	10.02	0.018	Hg <sup>199m</sup>	IT $\gamma e^-$ 0.368, 0.158	42 m
Hg <sup>202</sup>	29.80	3.8	Hg <sup>203</sup>	$\beta^-$ 0.21 (100%) $\gamma_1$ e <sup>-</sup> 0.279	47 d
Hg <sup>204</sup>	6.85	0.43	Hg <sup>205</sup>	$\beta^-$ 1.8; $\gamma$ 0.203	5.5 m

A consideration of the magnitude of the isotopic activation cross sections and abundances, shown in Table XXVII, suggests that in a neutron irradiation during a fixed time period, 65-hour Hg<sup>197</sup> will be formed in highest abundance, followed by 47-day Hg<sup>203</sup>, 24-hour Hg<sup>197m</sup>, and finally by 5.5-minute Hg<sup>205</sup>.

If one considers the irradiation time required to produce the saturation activity of each product, the superiority of the Hg<sup>196</sup>  $(n,\gamma)$  Hg<sup>197</sup> reaction

becomes evident: To form the saturation activity of  $\text{Hg}^{197}$  requires an irradiation time of about 5 days, whereas  $\text{Hg}^{197\text{m}}$  requires about two weeks, and  $\text{Hg}^{203}$  several months. After irradiation of a sample containing Hg, a cooling period of 2-3 days has been recommended.<sup>155</sup> About 2-3 days after the end of the irradiation only  $\text{Hg}^{197}$  is the predominant activity. In a one-week irradiation about 50 times more  $\text{Hg}^{197}$  is formed than  $\text{Hg}^{203}$ .

In analyses where  $\text{Hg}^{197}$  or  $\text{Hg}^{197\text{m}}$  is used to determine mercury concentrations, care must be taken to ensure that platinum is absent from the sample since 20 hour  $\text{Pt}^{197}$ , like  $\text{Hg}^{197,197\text{m}}$ , also decays to stable  $\text{Au}^{197}$ . The formation cross section for  $\text{Pt}^{197}$  by thermal neutrons in platinum of natural isotopic composition is about 280 millibarns. After 3 days of cooling,  $\text{Pt}^{197}$  has decayed to less than 10 percent of its initial activity. It appears that 40 parts of platinum would simulate the presence of 1 part of mercury.

Full assessment of the capabilities of activation analysis is dependent on a knowledge of the detection limits for the elements to be determined. Experimentally measured sensitivities<sup>154</sup> for the major mercury isotopes are summarized in Table XXVIII.

TABLE XXVIII. Experimental sensitivities for the determination of mercury with thermal neutrons from a nuclear reactor.

Isotope	Half-Life	Gamma Ray Energy (MeV)	Photo Peak Yield (cpm/gm Hg)	Detection Limit ( $\mu\text{g}$ )	Interfering Product
$\text{Hg}^{197\text{m}}$	24h	0.133	$1.2 \times 10^8$	0.083	
$\text{Hg}^{197\text{g}}$	65h	0.19	$1.3 \times 10^7$	0.79	
$\text{Hg}^{199\text{m}}$	42m	0.368	$1.3 \times 10^8$	0.77	
		0.157	$9.0 \times 10^8$	0.11	$\text{Hg}^{197}$
$\text{Hg}^{203}$	47d	0.278	$4.0 \times 10^7$	0.25	
$\text{Hg}^{205}$	5.5m	0.203	$2.5 \times 10^8$	0.41	$\text{Hg}^{199\text{m}}, \text{Hg}^{197\text{m}}, \text{Hg}^{203}$

See page 201 for copyright citation.

The data presented in Table XXVIII have been corrected to the following conditions:

- (1) thermal neutron flux =  $4.3 \times 10^{12}$  neutrons/sq. cm.-second,

- (2) irradiation period = 1.00 hour,
- (3) activity is that at end of irradiation,
- (4) detector is a 3-inch x 3-inch solid NaI(Tl) crystal,
- (5) beta-particle absorber interposed between source and detector is 1/2-inch thick, 3-inch diameter polystyrene disc,
- (6) counting geometry ~31%, and
- (7) analyzers are 400-channel type.

The photo peak yield in Table XXVIII, has been computed from the equation

$$Y = \frac{A}{\Delta t} e^{\lambda t_1} \frac{F}{W} \frac{1 - e^{-\lambda t_2}}{1 - e^{-\lambda t_3}}, \quad (1)$$

where A is the number of counts in the photopeak;  $\Delta t$ , the length of the count in minutes;  $\lambda$ , the decay constant;  $t_1$ , the time between the end of irradiation and the midpoint of the count; W, the element weight;  $t_2$ , the standard irradiation of 1 hour; and  $t_3$ , the actual irradiation time. The fraction  $(1 - e^{-\lambda t_2})/(1 - e^{-\lambda t_3})$  converts the result to a standard irradiation time of one hour.

A correction factor, F, was applied when counting times were longer than one half life, for, under this condition the average activity (counts/length of count) is larger than, rather than equal to, the activity at the midpoint of count. The correction converts the average activity to that at the midpoint of the count, and is given by

$$F = \frac{\frac{1}{\Delta t} \int_0^{\Delta t} A^0 e^{-\lambda t} dt}{\frac{1}{\Delta t} A^0 e^{-\lambda t} dt} = \frac{\lambda \Delta t e^{-\lambda \Delta t / 2}}{1 - e^{-\lambda \Delta t}}, \quad (2)$$

where  $A^0$  is the activity at the start of the count and the count lasts from  $t = 0$  until  $t = \Delta t$ .

The detection limits, S, listed in Table XXVIII, were computed from the relation

$$S = \frac{k}{\bar{Y}} 10^{+6} \mu\text{g} ,$$

where the minimum detectable count rate under the photopeak,  $k$ , was chosen to be 100 cpm for activation product half-lives between one minute and one hour, and 10 cpm for half-lives longer than 30 minutes.

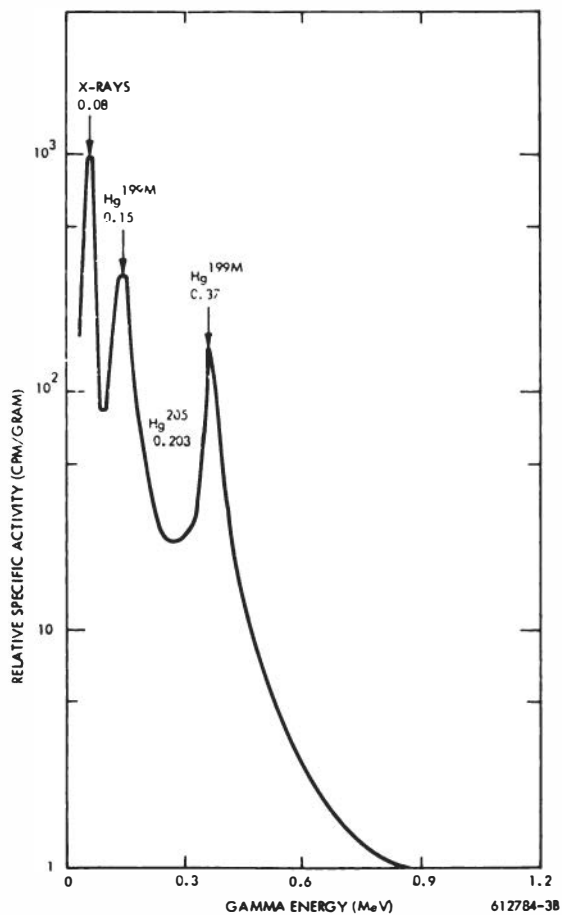

Figure 34. Gamma spectrum of neutron activated mercury of natural isotopic composition.

The gamma spectrum of neutron activated mercury of natural isotopic composition, observed with a 3" by 3" NaI(Tl) detector, is presented in Figure 34.

## b. Preparation of Standards

Because of the high capture cross section for thermal neutrons, the total weight of mercury to be used as standard should not exceed a few micrograms. The simplest way of weighing out such small amounts is by pipetting known volumes of a dilute - for example 50 mg Hg/liter-mercury solution into a quartz tube. The quartz tube then is sealed such that the lower end which contains the standardized solution is cooled to avoid the possibility of losses by evaporation.<sup>155</sup> An alternative way would be by pipetting the standard solution onto a small filter circle, adding the same volume of saturated H<sub>2</sub>S solution to precipitate HgS and careful drying.<sup>155</sup> The filter circle is placed into a quartz tube and sealed as above. The author has found the following method of sealing quartz tubes quite satisfactory. The bottom half of the quartz tube is wrapped with enough layers of asbestos tape so that tube and asbestos plug can be held easily by a laboratory clamp. The sealing which should not take more than 2-3 seconds is accomplished fastest by means of H<sub>2</sub>-O<sub>2</sub> burner. During the sealing, the asbestos plug and the quartz tube is kept wet with a fine water spray from a wash bottle. A more elaborate technique of sealing quartz tubes is described in Reference 155 and is also reproduced in full as Appendix I to Procedure 27.

## c. Sources of Error

In any kind of activation analysis samples and standards ideally should be exposed to the same flux. Target atoms with large capture cross sections can cause a local flux perturbation, i.e., samples and standards are no longer in the same neutron flux. The flux perturbation<sup>156</sup> is the product of two superimposed effects: flux depression and self-shielding. Strong neutron absorption in sample and standards is the cause of local flux depressions. By their strong neutron absorption the outer layers of a standard or sample shield the inner layers from undergoing (n, $\gamma$ ) reactions. A measure for the difference in flux as a function of location is the flux



depression  $\Delta \phi/\phi$ . If one considers the neutron absorbing sample to be a spherical shell of radius  $r_0$  and thickness  $t$ , placed in a uniform neutron flux  $\phi$ , the flux depression, according to Hughes,<sup>157</sup> can be computed from the expression

$$\Delta \phi/\phi = (3N \cdot \sigma_c \cdot t) / (\lambda_{tr}/r + \lambda_{tr}/L), \quad (3)$$

where  $N$  is the number of target nuclei/cm<sup>3</sup>,  $\sigma_c$  the capture cross section,  $\lambda_{tr}$  the transport mean free path and  $L$  the diffusion length of the neutrons. Equation (3) holds strictly only for flux depression of a few percent or less and should be taken to give merely current order of magnitude estimates.

The self-shielding effect of Hg<sup>196</sup> at a flux of 10<sup>12</sup> neutrons/sec cm<sup>2</sup> when based on thermal neutron cross section is less than 0.3 percent of the expected Hg<sup>197</sup>,<sup>197m</sup> activity. This effect may be more serious if resonance capture is important.

An empirical relation between the neutron absorption cross section  $\sigma_{abs}$ , in barns, the sample weight  $W$ , in grams, which will produce a self-shielding effect of about ten percent, has been derived by Kamemoto<sup>158</sup> in the form

$$\frac{\sigma_{abs} W}{\text{Atomic Weight of Sample}} = 0.03$$

This relation permits to adjust the sample size to minimize or avoid self-shielding problems.

For discussions of the problem of flux perturbation for different geometries of the neutron absorber see References 155, 159-161.

Another potential source of error is burn-up of the target nuclei which occurs where neutron capture reactions take place in nuclides with large capture cross sections such as Hg<sup>196</sup>. The amount of burn-up can be computed from the relation<sup>162</sup>

$$N = N_0 \exp [-\sigma_a \cdot \phi \cdot t],$$

where  $N_0$  is the number of target atoms before irradiation,  $\sigma_a$  the isotopic absorption cross section,  $\phi$  the neutron flux in  $n/cm^2$  sec and  $t$  the length of the irradiation. In the case of  $Hg^{196}$  the burn-up is about 0.001 percent/hr at a flux of  $10^{12}$  neutron/sec  $cm^2$  and about 0.1 percent at a flux of  $10^{14}$  neutrons/sec  $cm^2$ .

Finally, when attempting to increase the detection sensitivity by using higher neutron fluxes and long irradiation times, second-order interference is likely to occur.<sup>163</sup> Second-order interference may be defined as the systematic error in activation analysis introduced by successive neutron capture reactions according to

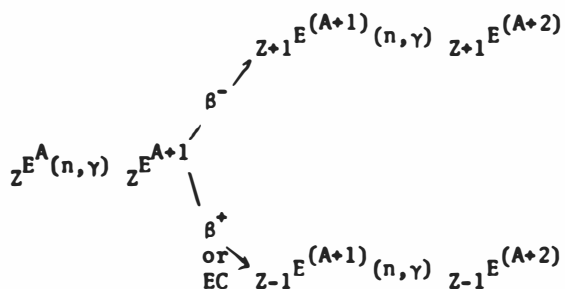

If one attempts to determine by activation analysis the concentration of elements  $Z_{-1}E$  and  $Z_{+1}E$ , second-order reactions may lead to interference if either or both elements are measured in a matrix consisting predominantly of  $Z E$  because above reactions add to the concentration of the elements being measured. Fortunately, no second-order interference is expected in mercury determinations by activation analysis.

#### d. Re-activation Analysis of Mercury

This method uses activation analysis as a means for determining the radiochemical yield accurately of a counting sample in the course of a conventional activation analysis.<sup>164,165</sup> The sequence of operations is as follows: activation of the sample, separation of mercury and preparation of a counting sample, counting, sufficient cooling to permit  $Hg^{197}$  and

Hg<sup>205</sup> to decay to negligible levels, reactivation, and counting. Since only small amounts of carrier should be added, the weight of mercury in the sample cannot be neglected in the calculation of the chemical yield.

The weight of mercury in the sample can be computed from the equation

$$W = \frac{A_{\text{sam}} \times W_c \times W_{\text{st}}}{\frac{A_{\text{st}} \times A_{\text{sam}}^1 \times W_{\text{st}}^1}{A_{\text{st}}^1} - A_{\text{sam}} \times W_{\text{st}}} \quad (\text{gm}),$$

where  $W$  is the weight of mercury in gm in the sample,  $A_{\text{st}}$  the Hg<sup>205</sup> activity induced in the mercury standard in the first irradiation,  $W_{\text{st}}$  the weight of the mercury standard in grams,  $A_{\text{sam}}$  the activity of Hg<sup>205</sup> formed in the first irradiation,  $W_c$  the weight of mercury carrier added to the irradiated sample,  $A_{\text{sam}}^1$  the Hg<sup>197</sup> activity induced in the second irradiation in the sample,  $A_{\text{st}}^1$  the Hg<sup>197</sup> activity induced in the standard in the second irradiation, and  $W_{\text{st}}^1$  the weight of the mercury standard in grams for the second irradiation. It appears that the concentration range in which mercury can be determined by re-activation lies between 5  $\mu\text{g}$  to about 400  $\mu\text{g}$ . Interfering elements are Cd, Cu, and Au.

#### e. Fast Neutron Activation Analysis

During the past decade, several low-cost positive ion and electron accelerators have become commercially available for use as neutron generators. The characteristics of several types of accelerators are summarized in Table XXIX.

Fast neutron activation is generally utilized where a large number of analyses have to be performed at low cost and where some sacrifice in sensitivity can be tolerated. Thus far, fast neutron activation has been applied to mercury analyses only with 14-MeV neutrons from Cockcroft-Walton accelerators, and with 2 - 5 MeV neutrons from Van de Graaff accelerators. The fairly limited extent of fast-neutron activation work on mercury might

TABLE XXIX. Characteristics of several types of accelerators.

Type	Particle and Target	Ion Current	Particle Energy	Neutron Emission (neutrons per second)
Cyclotron	Be <sup>9</sup> (d,n)B <sup>10</sup>	1 ma	8 MeV	3 x 10 <sup>13</sup>
Van de Graaff	Be <sup>9</sup> (d,n)B <sup>10</sup>	50 $\mu$ a	2 MeV	1 x 10 <sup>10</sup>
Van de Graaff	Be <sup>9</sup> ( $\alpha$ ,n)He <sup>4</sup>	1 ma	3 MeV	1 x 10 <sup>9</sup>
Cockcroft-Walton	T(d,n)He <sup>4</sup>	100 $\mu$ a	250 KeV	1 x 10 <sup>9</sup>
Cockcroft-Walton	T(d,n)He <sup>4</sup>	1 ma	14 MeV	4 x 10 <sup>10</sup>
Betatron	e-U	3 $\mu$ a	80 MeV	2 x 10 <sup>10</sup>
Linear Accelerator	e-U	25 ma	14 MeV	4 x 10 <sup>14</sup>

in part be due to the lower sensitivity that can be achieved, compared with thermal neutron activation.

Sensitivities for several possible activation reactions, listed in Table XXX,<sup>166</sup> were computed under the assumption of an one-hour irradiation with a flux of 10<sup>9</sup> neutrons/cm<sup>2</sup>/sec passing through the target.

Table XXX. Sensitivities for several activation reactions with 14-MeV neutrons.

Reaction	$\sigma$ (mb)	Half-Life	R (dpm/gm)	Sensitivity (g)	Gamma Radiation (MeV)	Other Radiation
Hg <sup>200</sup> (n,p)Au <sup>200</sup>	3.6 $\pm$ 0.4	48m	1.45 x 10 <sup>3</sup>	1,150	3.67(24%), 1.23(24%), 1.36(1%)	2.18(76%), 0.6(24%)
Hg <sup>201</sup> (n,p)Au <sup>201</sup>	2.1 $\pm$ 0.3	26m	664	2,500	0.55	1.5
Hg <sup>202</sup> (n, $\alpha$ )Pt <sup>199</sup>	1.01 $\pm$ 0.1	31m	665	2,500	0.074, 0.197, 0.246, 0.318, 0.475, 0.54, 0.72, 0.79, 0.92	0.8, 1.1, 1.3, 1.7
Hg <sup>200</sup> (n, $\alpha$ )Pt <sup>197,197m</sup>	1.77 $\pm$ 0.35	1.3h, 19h	mixed yield		0.3291 others	

Sensitivity in Table XXX is defined as that amount of material in grams which yield 100 dpm at the end of the irradiation, regardless of decay scheme. Of course, where only one particular gamma ray is counted, the decay scheme must be considered. Another useful piece of information listed in Table XXX is the radiochemical yield which has been computed by

$$Y = \frac{10^9 A \sigma f}{W} [1 - \exp(-0.693 t/T)],$$

where  $Y$  is the radiochemical yield in dpm/gm of element in the sample,  $A$  is Avogadro's number,  $\sigma$  the reaction cross section in  $\text{cm}^2$ ,  $f$  the fraction of the target isotope in element,  $W$  the atomic weight,  $t$  the length of irradiation, and  $T$  the half-life of the activation product in the same units as  $t$ . The reaction cross sections were taken from Coleman.<sup>167</sup>

The sensitivity limits for 57 elements for 14-MeV neutron activation analysis at a neutron flux of  $4.0 \times 10^8$  neutrons/ $\text{cm}^2$  sec were measured by M. and J. Cuypers.<sup>168</sup> Their results pertaining to mercury are summarized in Table XXXI.

TABLE XXXI. Detection limit for 14-MeV neutron activation analysis of mercury at a neutron flux of  $2 \times 10^8$  neutrons/ $\text{cm}^2$ /second.

Radio-isotope Produced	Half Life	Gamma Ray Energy (MeV)	$T_{\text{act}}$	$T_{\text{dec}}$	$T_{\text{cnt}}$	Counts per $\text{mg}/T_{\text{cnt}}$	Detection Limit (mg)
X-ray		0.075	5 m	1 m	5 m	224	0.43
$\text{Hg}^{199\text{m}}$	44 m	0.158	5 m	1 m	5 m	210	0.46
	40 m	0.24	5 m	1 m	5 m	38	2.5
$\text{Hg}^{199\text{m}}$	44 m	0.37	5 m	1 m	5 m	30	3.8

To facilitate sensitivity and yield computations, measured reaction cross sections for 14 MeV neutrons with mercury isotopes were compiled from the pertinent literature and are summarized in Table XXXII.

A recent comprehensive investigation<sup>172</sup> on the detection limits of 47 elements in 14-MeV neutron activation showed that 1-10  $\mu\text{g}$  of mercury are detectable in a 20-minute irradiation with  $10^9$  neutrons/ $\text{sec cm}^2$  when the 158-keV gamma ray of 44-minute  $\text{Hg}^{199\text{m}}$  is counted. The reactions leading to  $\text{Hg}^{199\text{m}}$  possibly are  $\text{Hg}^{199} (n, n')$  and  $\text{Hg}^{198} (n, 2n)$ .

Although largely neglected, the application of 3 MeV neutrons to activation analyses holds considerable promise. The energy of such neutrons is not high enough to induce  $(n, 2n)$  reactions; also, the cross sections for  $(n, p)$  and  $(n, \alpha)$  reactions with 3 MeV neutrons are very small.

TABLE XXXII. Measured activation cross sections for 14-MeV neutrons and mercury.

Reaction	Half-life	Cross Section (millibarns)	Reference
$\text{Hg}^{200}(n, \gamma)\text{Hg}^{201}$	stable	$< 6 \times 10^4$	169
$\text{Hg}^{201}(n, \gamma)\text{Hg}^{202}$	stable	$< 6 \times 10^4$	169
$\text{Hg}^{202}(n, \gamma)\text{Hg}^{203}$	46.6 d	$3.8 \times 10^4$	169
$\text{Hg}^{199}(n, n')\text{Hg}^{199m}$	44 min	$559 \pm 68$	170
$\text{Hg}^{200}(n, 2n)\text{Hg}^{199m}$			
$\text{Hg}^{196}(n, 2n)\text{Hg}^{195m}$	40 h	$1580 \pm 195$	170
$\text{Hg}^{198}(n, 2n)\text{Hg}^{197g}$	64.14 h		
$\text{Hg}^{198}(n, 2n)\text{Hg}^{197m}$	23.8 h	$967 \pm 117$	170
$\text{Hg}^{204}(n, 2n)\text{Hg}^{203}$	46.6 d	$2270 \pm 272$	170
$\text{Hg}^{198}(n, p)\text{Au}^{198}$	64.8 h	$5.83 \pm 0.82$	170
$\text{Hg}^{200}(n, p)\text{Au}^{200}$	48 min	3.6	170
$\text{Hg}^{201}(n, p)\text{Au}^{201}$	26 min	2.1	170
$\text{Hg}^{202}(n, p)\text{Au}^{202}$	30 sec	1.4	171
$\text{Hg}^{200}(n, \alpha)\text{Pt}^{197}$	80 min $\rightarrow$ 18 h	1.8	169
$\text{Hg}^{202}(n, \alpha)\text{Pt}^{199}$	14 sec $\rightarrow$ 31 min	1.0	169

However, many low lying levels in most elements can be excited by (n,n') with 3 MeV neutrons.

In the case of mercury, the ambiguity as to the activation reaction is one of the major obstacles against using 3 MeV in activation analysis. For the reaction  $\text{Hg}^{199}(n, n')\text{Hg}^{199m}$  with 3-MeV neutron an average cross section of 95 mb has been reported.<sup>173</sup>

The feasibility of using fast fission spectrum neutrons for mercury activation analysis was demonstrated by Menapace.<sup>174</sup> The activation reactions studied were  $\text{Hg}^{198}(n, \gamma)\text{Hg}^{199m}$  and  $\text{Hg}^{199}(n, n')\text{Hg}^{199m}$ , both occurring simultaneously. The reaction cross section ratio (n,  $\gamma$ )/(n, n') for the respective reactions with fast fission spectrum neutrons in the Ames reactor was found to be 5.82, i.e., the (n,  $\gamma$ ) reaction predominates, yet about 17 percent of the  $\text{Hg}^{199m}$  activity is due to the (n, n') reaction. In a three-minute irradiation in the core of the Ames reactor, mercury can be determined with a sensitivity of 20 micrograms by counting  $\text{Hg}^{199m}$ . Incidentally, the samples were merely packed in Cd containers for irradiation.

## f. Photoactivation Analysis of Mercury

The formation of nuclear isomers by  $(\gamma, \gamma')$  reactions has been investigated as to possible analytical applications.<sup>175</sup> The product formed when mercury is irradiated with bremsstrahlung from a 1mA current of 3-MeV electrons was found to be 44-minute  $\text{Hg}^{199\text{m}}$ . The flux traversing the target was estimated to be  $3 \times 10^{14}$  photons/cm<sup>2</sup> sec. A one-hour irradiation of 16.5 g of mercury in 30 ml of solution produced a specific activity of 2000 cpm/gram at the end of the irradiation. For analytical measurements with a ten percent standard deviation a minimum count rate of 74 cpm is required at the end of the irradiation. Thus, the minimum weight of mercury which can be determined under above conditions is 37 mg or 1200 ppm. With 6-MeV bremsstrahlung, a sensitivity of about 0.5 mg of mercury has been achieved.<sup>176</sup>

A comprehensive study<sup>177</sup> of the yields of radioactivity induced by  $(\gamma, n)$  reactions with 20 MeV bremsstrahlung showed that for the reaction  $\text{Hg}^{204}(\gamma, n)$  a yield of  $3.9 \times 10^7$  dpm/mole for each roentgen of bremsstrahlung can be expected. The minimum weight of mercury that could be determined in a one roentgen irradiation would be of the order of 1-2 milligrams.

The photoactivation yields of 44-minute  $\text{Hg}^{199\text{m}}$  in terms of count rate of the 159 keV photopeak per gram mercury is plotted in Figure 35 as a function of the maximum incident bremsstrahlung energy.<sup>175, 176, 228</sup>

One of the advantages of nuclear photoexcitation as an analytical tool is its potentially high degree of selectivity since a nuclear transmutation is induced in only a few elements with 6-MeV photons and is insignificant in most elements even under 8-MeV bremsstrahlung irradiation.

There are indications that the determination of mercury traces, at least in biological specimens, by photoactivation<sup>178, 179</sup> is being considered to be a powerful method supplementing neutron activation particularly in laboratories which have easy access to electron linacs.

When mercury of natural isotopic composition is irradiated with 30 MeV photons, the products of the reactions  $\text{Hg}^{198}(\gamma, n)\text{Hg}^{197\text{m}}$ ,  $\text{Hg}^{200}(\gamma, n)\text{Hg}^{199\text{m}}$ , and  $\text{Hg}^{204}(\gamma, n)\text{Hg}^{203}$  are the major activities formed.<sup>180</sup> In Figure 36,

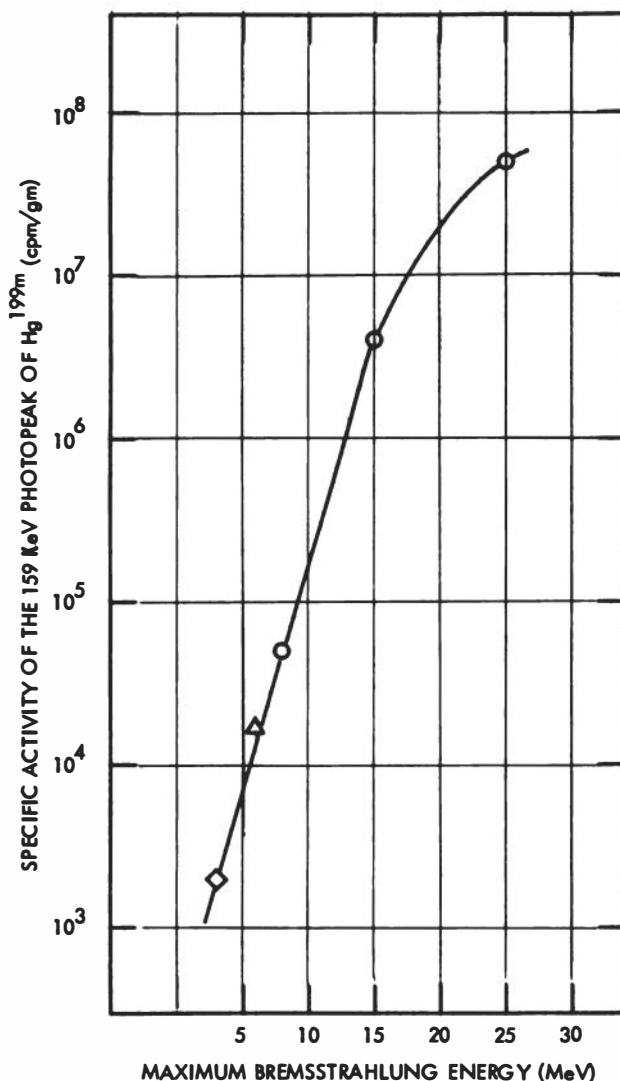

Figure 35. Yield of the 159 keV photopeak of Hg<sup>199m</sup> as a function of the maximum incident bremsstrahlung energy. (◊ taken from Ref. 175, △ Ref. 176, and ○ Ref. 228).

the gamma spectrum of above activation is shown, taken 3 hours after the end of the irradiation.

#### g. Analysis by Prompt Gamma Ray Spectrometry

The Bohr theory of nuclear reactions assumes thermal neutron capture to be a two-step process: absorption of the incident neutron by the target nucleus to form a short-lived activated complex, the Compound Nucleus, and



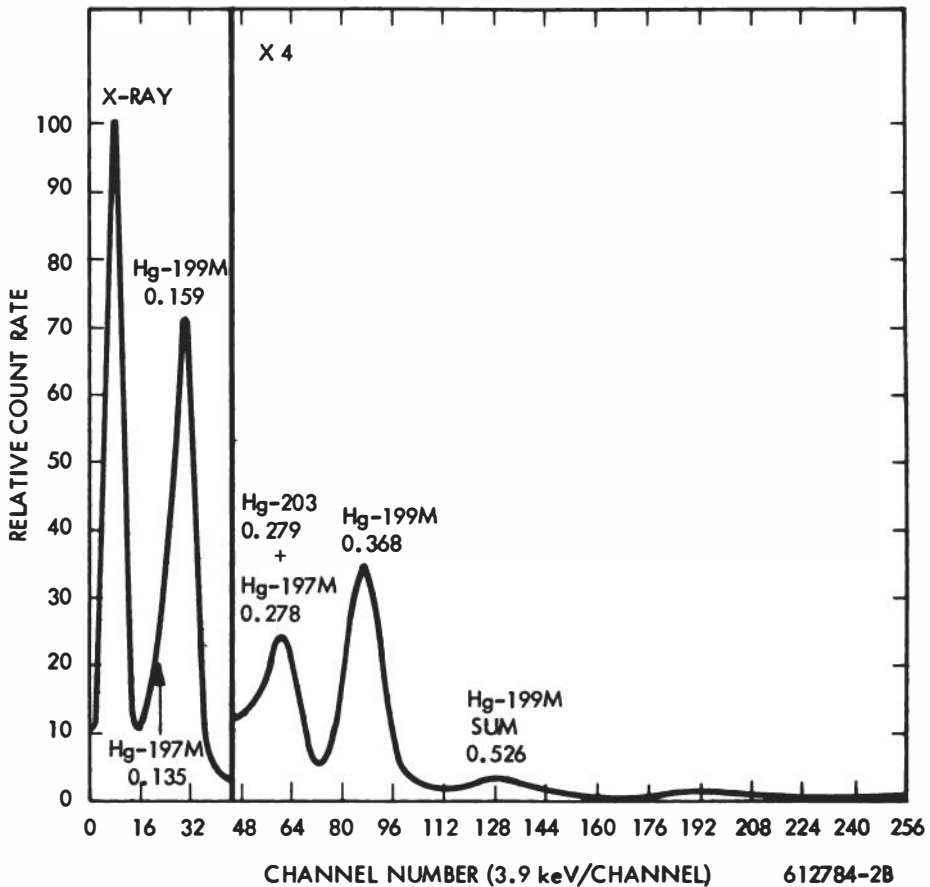

Figure 36. Gamma spectrum of natural mercury irradiated with 30 MeV photons.

deexcitation of the Compound Nucleus within  $10^{-14}$  to  $10^{-15}$  seconds after its formation by the emission of one or several photons. These prompt gamma quanta represent the binding energy of the neutron to the target nucleus.

Activation analysis via the measurement of the prompt gamma rays is independent of the half-life of the activation product since capture reactions proceed without growth or decay characteristics. The saturation activity is produced as soon as the neutron beam is turned on.

Exploratory experiments to measure the concentration of mercury in ores and ore concentrates by prompt gamma spectrometry have been carried out in the USSR.<sup>181</sup> Ores whose mercury content ranged between 0.01 percent to several percent were exposed to a collimated beam of thermal neutrons

from a reactor. The intensity of the prompt gamma rays was measured with a multichannel analyzer equipped with a 2 x 2 inch NaI (Tl) detector. The sensitivity of the mercury determination was 0.1 percent with an accuracy of 10 percent when the intensity of 3.77, 4.35, and 4.81 MeV gamma rays was compared with prompt gamma spectra obtained with standards.

A major drawback in using prompt gamma ray spectrometry in conjunction with thermal neutron activation is the difficulty in distinguishing the prompt gamma rays emitted from the sample from prompt gamma rays produced by (n, $\gamma$ ) reactions in the surroundings, gamma rays caused by inelastic scattering of fast neutrons in sample and surroundings, fast neutrons scattered into the detector by sample and surroundings and reactor gamma rays scattered by sample and surroundings. A sophisticated method of analysis by prompt gamma spectrometry which minimizes these sources of error has been devised by Isenhour and Morrison.<sup>182</sup> The workers developed a technique of modulating a collimated beam of thermal neutrons using a neutron chopper operating at 1000 cps which cancelled >99 percent of the half-life dependent gamma rays to obtain a pure prompt gamma spectrum. Signals generated by the chopper disc were used to switch the memory section of a multichannel analyzer in synchronizaton with the modulated neutron beam and thus recording prompt and delayed gamma spectra in different sections of the analyzer. The two half-cycles of the chopper--prompt plus delayed gamma quanta and delayed gamma quanta--after correction for background were subtracted to give the prompt gamma spectrum. The requirement of using a collimated and modulated neutron beam reduces the available flux by about six orders of magnitude. The attainable sensitivity compared with conventional gamma spectrometry is appreciably lower. With improved collimation of the neutron beam, better experimental geometry and larger reactors, higher thermal neutron fluxes will become available making prompt gamma spectrometry competitive with delayed gamma ray measurements. The ultimate sensitivity for the measurement of mercury by prompt gamma spectro-

metry is four orders of magnitude higher than using conventional gamma spectrometry.

Many of earlier measurements on prompt gamma ray spectra were carried out with magnetic pair and Compton spectrometers and were intended for application in nuclear physics. To be useful for analytical purposes such spectra should be taken with the same instrumentation as used for analysis: gamma spectrometers with NaI (Tl) detectors. A comprehensive program to compile an atlas of thermal neutron capture gamma spectra of naturally occurring elements has been conducted by Greenwood.<sup>183</sup> The capture gamma ray spectrum of mercury of natural isotopic composition is presented in Figure 37,

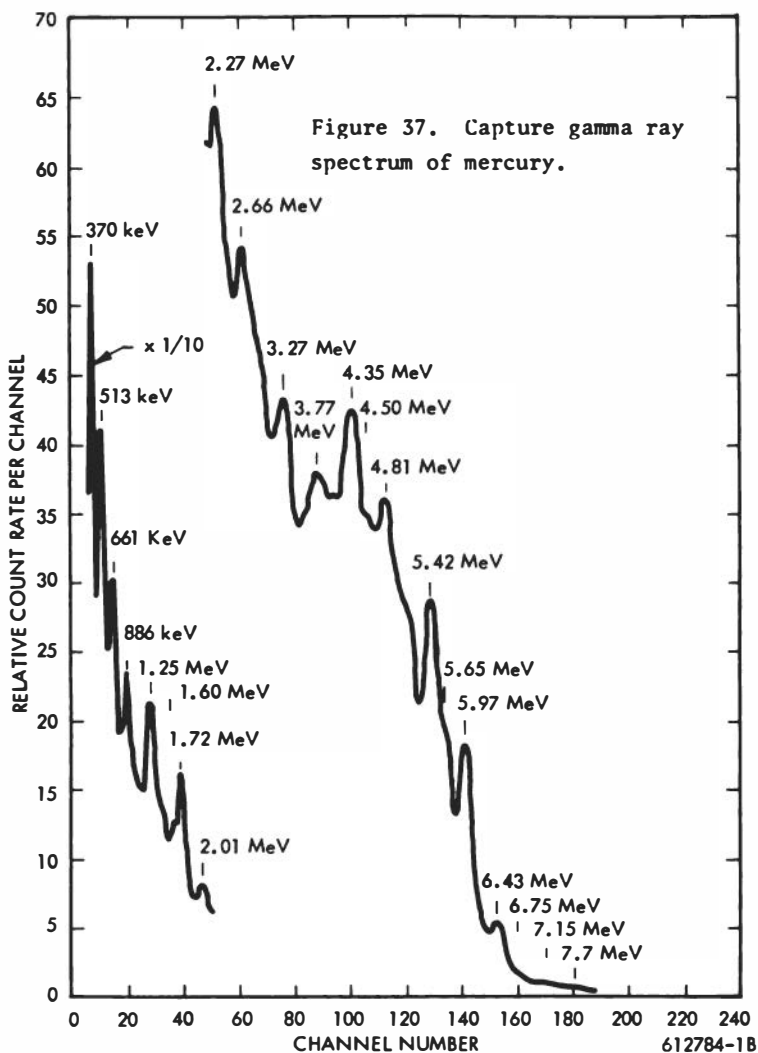

observed low energy gamma rays and their assignments are in Table XXXIII and the high energy gamma rays and their assignments are summarized in Table XXXIV.

Table XXXIII. Low energy capture gamma rays of mercury.

Adyasevich <sup>184</sup>	Estulin <sup>187</sup>	Segel <sup>186</sup>	Greenwood <sup>183</sup>	Assignment
E <sub>γ</sub> (keV)	E <sub>γ</sub> (keV)	E <sub>γ</sub> (keV)	E <sub>γ</sub> (keV)	
			38	
			71	Hg K X-ray
			160	Prob. backscatter from 370 keV line
			193	Prob. Compton edge of 370 keV line
370	372	370	370	
580			576	
680			660	
830				
900			820	
1010		1220		
1100				
1220				
1290			1230	

Table XXXIV. High energy capture gamma rays of mercury.

Adyasevich <sup>184</sup>		Kinsey et al. <sup>185</sup>		Segel <sup>186</sup>	Greenwood <sup>183</sup>	Assignment
E <sub>γ</sub> (MeV)	I <sub>γ</sub>	E <sub>γ</sub> (MeV)	I <sub>γ</sub>	E <sub>γ</sub> (MeV)	E <sub>γ</sub> (MeV)	
7.66	0.1				7.7	Full energy capture gamma ray
7.05*	0.06					
6.44	4.5	6.446	5	6.44	6.43	Full energy capture gamma ray
6.31	2.4			6.31		
5.99	10	5.959	12	5.96	5.97	Full energy peak
						First escape peak of 6.43 MeV line
5.38*	2					
5.07	6.7	5.047	5	5.07	5.05	
5.44	4.5	5.39	3		5.42	Several escape peaks of 6.43 MeV line,
4.28*	1.4					first escape peak of 5.97 MeV line
5.05	6	5.07	3			Full energy peak
4.94	3	4.95	1			
4.82	10	4.83	3		4.81	First escape peak of 5.42 MeV line
		4.73	4			Full energy peak
4.69	6	4.66	2			
4.59*	3.5					
4.12	>1					
3.80	>1					
3.60	>0.5					
3.50	>0.5					
3.25	>3					
3.14	>3				3.27	Full energy peak
2.89	>1					
2.64	>3				2.66	First escape peak of 3.27 MeV line.
2.40	>1					
2.29	>4				2.27	
2.10	1					
2.02	6			2.02	2.01	
1.85	1					
1.73	13			1.73	1.72	
1.62*	-2					
1.59	-1			1.59	1.60	
1.49*	2					
1.41	2					

#### h. Tabular Survey on Mercury Analysis by Activation

During the past decade, mercury determinations by activation analysis have been carried out in a multitude of substances with the emphasis on

life sciences. The titles of representative papers, grouped in life sciences (biology, medicine, and forensic applications), geosciences (geology, geochemistry, and cosmochemistry), materials and miscellaneous are presented in Tables XXXV-XXXVIII. These tables, by no means complete, are intended to provide merely a quick survey and possibly some initial references.

TABLE XXXV. Application of activation analysis to the determination of mercury in life sciences.

Title of Paper	Remarks	Ref.
Radioisotopes in the Detection of Pesticide Residues	Hg in foods, biosphere	1
(n, $\gamma$ ) Analysis of Human Blood		2
The Use of Activation Analysis in Procedures for the Removal and Characteristics of the Surface Contaminants of Hair		3
Identification of Metals in Tattoo Marks by Activation Analysis and Gamma Spectrometry		4
Investigations in Neutron Activation Analysis	14 MeV neutrons, frozen whole blood	5
Freezing Technique in Neutron Activation Analysis	whole blood, water	6
Methods of Activation Analysis for Mercury in the Biosphere and in Foods		7
Neutron Activation Analysis and its Application to Medical Research	Hg in drugs, antibiotics	8
Determination of Trace Elements in Human Hair by Neutron Activation and the Application to Forensic Science		9
Activation Analysis Application to the Determination of Iodine, Mercury, Copper, Manganese, and Zinc in Biological Samples		10
Radioactivation Analysis, A New Technique at the Service of Biology		11
Activation Analysis as a Tool for Medical Research	blood	12
Determination of Mercury in Potato Flour		13
Use of Radioisotope Techniques in Sweden	Hg poisoning	14
Applications of Neutron Activation Analysis in Scientific Crime Detection		15
Chemical Element Analysis of Radioactive Mixtures in Biological Materials		16
Activation Analysis as a Method of Investigation in Dentistry		17
Quantitative Determination of Mercury in Hair by Activation Analysis		18
Present Status of Activation Analysis Applications in Criminalistics	Hg in hair	19
Determination of Trace Elements in Pharmaceuticals by Neutron Activation Analysis		20
Determination of Mercury Content of Human Blood by Activation Analysis		21

TABLE XXXV. Application of activation analysis to the determination of mercury in life sciences (Continued)

Title of Paper	Remarks	Ref.
Highlights of the Y-12 Bioanalysis Laboratory Operation	Hg in urine	22
Determination of Mercury in Wheat and Tobacco Leaf by Neutron Activation Analysis Using Hg <sup>197</sup> and a Simple Extraction Separation		23
Investigation of Crimes are by Activation Analysis	Hg in hair	24
Investigation of Trace Elements in Marine and Locustine Deposits by Means of a Neutron Activation Method		25
Simultaneous Estimation of Copper, Zinc, Cadmium and Mercury in Biological Materials by Neutron Activation Analysis		26
A Method for the Detection of Mercury by Radioactivation Analysis	wood pulp, human feces, brain and liver tissues of rabbits	27
Determination of Some Trace Elements in Human Serum-Albumin by Neutron Activation Analysis		28
Trace Elements in the Lung		29
Contribution to the Experimental Determination of Trace Metals in Biological Material by Activation Analysis by Thermal Neutrons		30
Application of Radioisotopes for Analyses V. Neutron Activation Analysis of Agricultural Samples		31
Estimation of Mercury in Biological Material by Neutron Activation Analysis		32
Simultaneous Determination of Mercury and Arsenic in Biological and Organic Materials by Activation Analysis		33
Determination of Trace Elements in Drugs by Neutron Activation Analysis		34
Determination of Mercury in Urine by Radioactivation		35,36
Trace Elements in the Conductive Tissue of Beef Heart Determined by Neutron Activation Analysis		37
Activation Analysis of Mercury		38
Activation Analysis of Mercury in Cellulose Products		39

## REFERENCES TO TABLE XXXV.

1. Anon., Panel Proceedings Series, Proceedings of a Panel held in Vienna, 12-15 April 1965. Intern Atomic Energy Agency, Vienna, Austria (1965).
2. Asai et al., Ann. Rep. Rad. Center Osaka Prefect. 7, 99 (1966).
3. L. C. Bate, J. Forensic Sci. 10, 60 (1965).
4. Berne et al., Acta Dermato-Venerol. 42, 149 (1962).
5. D. Brune, Svensk Kem. Tidsk. 78, 336 (1966).
6. D. Brune and O. Landstroem, Radiochim. Acta 5, 228 (1966).
7. Christell et al., Proceedings of the 1965 Intern. Conf. on Modern Trends in Activation Analysis, p. 380, College Station, Texas, Texas A and M University (1965).
8. N. E. Chupeev and A. B. Dukenbaeva, Gig. Sanit. 32, 76 (1967).
9. Coleman et al., Atomic Weapons Research Establishment Report AWR/E-0-86/66 (1967).
10. Comar et al., Bull. Soc. Chim. France 1962, p. 56.
11. D. Comar, Bull. Inform. Sci. Tech. (Paris) 86, 3 (1964).
12. D. Comar, Nucleonics 24 (No. 11), 54 (1966).

13. Das et al., Intern. J. Appl. Radiation Isotopes 17, 252 (1966).
14. L. G. Erwall, Isotope Radiation Technol. 4, 255 (1967).
15. Grimm, Madigan, and Ruch, General Atomics Report GA-4297 (1963).
16. T. A. Hall, Nucleonics 12 (No. 3), 34 (1954).
17. Harndt, Koeppe, and Oeser, Strahlentherapie, Sonderbande 65, 384 (1967).
18. O. Hoshino, Eisei Kagaku 12, 94 (1966).
19. R. E. Jarvis, Isotope Radiation Technol. 6, 57 (1968).
20. Johansen, Lunde, and Steinnes, Institut for Atomenergi, Kjeller, Norway, Report KR-91 (1965).
21. Kellershojn Comar, and LePoec, J. Lab., Clin. Med. 66, 168 (1965).
22. R. H. Kent, U. S. Atomic Energy Commission Report Y-KG-36 (1966).
23. C. K. Kim and J. Silverman, Anal. Chem. 37, 1616 (1965).
24. M. Kobayashi, Genshiryoku Kogyo 13 (No. 12), 43 (1967).
25. Landstrom, Samsahl, and Wenner, Aktiebolaget Atomenergi Report AE-296 (1967).
26. Livingston, Smith and Stojanovic, Talanta 14, 505 (1967).
27. K. Ijunggren and T. Westermark, Pure and Applied Chem. 1, 127 (1960).
28. Malvano, Rosa, and Grosso, Intern. J. Appl. Radiation Isotopes 18, 121 (1967).
29. M. M. Malokhia and H. Smith, Arch. Environ. Health 15, 745 (1967).
30. J. Pijck, Verhandl. Koninkl. Vlaam. Acad. Wetenschap. Belg., Kl. Wetenschap. 23, 1 (1961).
31. M. Shibuya, Nippon Dojo Hiriyogaku Zasshi 37, 126 (1966).
32. H. Smith, Anal. Chem. 35, 653 (1963).
33. B. Sjostrand, Anal. Chem. 36, 814 (1964).
34. Tuckermann, Bate, and Leddicotte, J. Pharm. Sci. 53, 983 (1964).
35. Y. Welwart, Israel Atomic Energy Commission Report IA-620 (1960).
36. Y. Welwart and T. Sonnino, Israel Atomic Energy Commission Report IA-685 (1961).
37. P. O. Wester, Acta Med. Scand. 178, 789 (1965).
38. T. Westermark and B. Sjostrand, Intern. J. Appl. Radiation Isotopes 9, 1 (1960).
39. Westermark, Sjostrand, and Bethge, Svensk Papperstidning 63, 258 (1960).

TABLE XXXVI. Mercury determination by neutron activation in geosciences.

Title of Paper	Remarks	Ref.
Microanalysis Used for Meteorites		1
Bismuth, Thallium, and Mercury in Stone Meteorites by Activation Analysis		2
Abundance of Mercury in Meteorites and Rocks by Neutron Activation Analysis		3
Neutron Activation Analysis of Mercury, Copper, and Arsenic in Marine Organisms		4
Nuclear Chemistry and Geochemistry Research (Progress Report)	meteorites, ocean deposits	5
Nuclear Chemistry and Geochemistry Research, Carnegie Inst. of Technology	Hg in meteorites	6
Aktivierungsanalytische Bestimmung von Spurenelementen in Steinmeteoriten	$3 \times 10^{-3}$ $\mu$ g Hg	7
Determination of Trace Elements by Chemical Analysis and Neutron Activation in Meteorites of the Collection of the Viennese Museum of Natural History		8
The Determination of Mercury in Rocks by Neutron Activation Analysis		9
Utilization of Activation Analysis in the Study of Silicates	14 MeV neutron; sensitivity 100-1000 $\mu$ g Hg	10
Determination of Concentrations of Heavy Elements in Meteorites by Activation Analysis		11
Investigation of the Geographical and Vertical Distribution of Several Trace Elements in Sea Water by Neutron Activation Analysis		12
Technical Progress Report on Nuclear Chemistry Research, Dec. 15, 1966 - Dec. 15, 1967.	Hg in meteorites	13

## REFERENCES

1. C. Duval, *Chim. Anal. (Paris)* **48**, 537 (1966).
2. W. D. Ehmann and J. R. Huizenga, *Geochim. et Cosmochim. Acta* **17**, 125 (1959).
3. W. D. Ehmann and J. F. Lovering, *Geochim. et Cosmochim. Acta* **31**, 357 (1967).
4. Hamaguchi, Kuroda, and Hosohara, *J. At. Energy Soc. Japan* **2**, 317 (1960).
5. T. P. Kohman, U. S. Atomic Energy Commission Report NYO-844-67 (1966).
6. T. P. Kohman, U. S. Atomic Energy Commission Report NYO-844-71 (1967).
7. W. Kiesel, *Z. Anal. Chem.* **227**, 13 (1967).
8. Kiesel et al., *Monatsh. Chem.* **98**, 972 (1967).
9. D. F. C. Morris and R. A. Killick, *Talanta* **11**, 781 (1964).
10. J. Perdijon, *Bull. Soc. Franc. Ceram.* **67**, 45 (1965).
11. Reed, Kigoshi, and Turkevich, *Geochim. et Cosmochim. Acta* **20**, 122 (1960).
12. D. F. Schulz and K. K. Turekian, *Geochim. et Cosmochim. Acta* **29**, 259 (1965).
13. N. Sugarman and A. Turkevich, U. S. Atomic Energy Commission Report COO-1167-3 (1967).

TABLE XXXVII. Application of activation analysis of mercury in materials.

Title of Paper	Ref.
Simultaneous Determination of Silver, Gold, and Mercury in High Purity Lead by Neutron Activation Analysis	1
Systematic Analysis of Impurities in Zone-Refined Aluminum and Iron by Irradiation in a Nuclear Reactor	2
Activation Analysis Investigation on High Purity Silicon	3
The Use of Ion-Exchange Chromatography in the Activation Analysis of Microimpurities in Silica	4
Activation Analysis of Mercury in High Purity Bismuth	5
Determination of Some Impurities in Gallium by Neutron Activation	6
Determination of Trace Element Diffusion in Quartz and Germanium	7
Determination of Impurities in Selenium by Activation Analysis	8
The Determination of Trace Impurities in Liquid Metal Coolants by Radioactivation Methods	9
Activation Analysis of Trace Contaminants in GaAs Semiconductor Materials	10
Gamma Spectrometric and Radiochemical Analysis for Impurities in Ultrapure Silicon	11
Application of Activation Analysis for the Determination of Microimpurities in Tellurium	12
Determination of Some Microadmixture in Selenium of High Purity	13

## REFERENCES

1. J. Op de Beeck and J. Hoste, *Anal. Chim. Acta* **35**, 427 (1966).
2. J. Gattet and P. Albert, *Compt. Rend.* **247**, 1861 (1958).
3. W. Gebaur and J. Martin, *Z. Anal. Chem.* **200**, 266 (1964).
4. Kalinin et al., *Doklady Akad. Nauk SSSR*, **141**, 98 (1961).
5. J. I. Kim and J. Hoste, *Anal. Chim. Acta* **35**, 61 (1966).
6. Krivanek, Kukula, and Vins, *J. Radioanal. Chem.* **1**, 219 (1968).
7. G. Leljaert, *Pure and Applied Chem.* **1**, 121 (1960).
8. W. Roehusch, *Kernenergie* **7**, 543 (1964).
9. A. A. Smales, *Proceedings of the International Conferences on the Peaceful Uses of Atomic Energy, Geneva, Vol. 9*, 273 (1955).
10. E. Szabo and H. Rausch, *Acta. Chim. Acad. Sci. Hung.* **54**, 231 (1967).
11. Thompson, Strause, and Leboeuf, *Anal. Chem.* **30**, 1023 (1958).
12. O. E. Zvyagintsev and V. I. Shamaev, *Radiokhimiya* **1**, 717 (1959).
13. O. E. Zvyagintsev and V. I. Shamaev, *Zhur. Anal. Khim.* **15**, 325 (1960).



TABLE XXXVIII, Miscellaneous applications of activation analysis for mercury.

Title of Paper	Ref.
Determination of Radiosensitizers by Neutron Activation Analysis	1
Determination of Mercury in Aqueous Samples by Means of Neutron Activation Analysis with an Account of Flux Disturbances	2
A Neutron Activation Study of the Solubility of Mercury in Water	3
The Determination of Mercury in Lithium Hydroxide and Lithium Carbonate by Activation Analysis	4
Neutron Activation of Traces in Electrolytic Zinc Sulphate Solutions. Part I. Simultaneous Determination of Mercury, Uranium, and Ytterbium.	5
Neutron Activation Analysis of Trace Elements in White Lead and the Possible Applications for Age Determination of Paintings	6
Determination of the Age of White Lead by Neutron Activation Analysis - Possible Application to Paintings	7
Determination of Mercury by Activation Analysis	8
Determination of Mercury in Ores and Concentrates by Gamma Spectrometry of Radiative Neutron Capture in the Horizontal Channel of VVR-S	9
Studying the Effects of Trace Elements on High Purity Lubricants Using Activation Analysis	10
Activation Analysis Determination of Impurities in Silico Chloroform	11
Substoichiometric Determination of Mercury Traces by Activation Analysis and by Isotope Dilution	12
Substoichiometric Determination of Traces of Metals	13

## REFERENCES

1. Altmann et al., Oesterr. Studiengesellschaft fur Atomenergie Report SGAE-BL-17/1966 (1966).
2. D. Brune and K. Jirlow, *Radiochim. Acta* **8**, 161 (1967).
3. S. S. Choi and D. G. Tuck, *J. Chem. Soc. (London)* **1962**, 4080.
4. W. N. Crofford and T. A. Kovacina, U. S. Atomic Energy Commission Report TID-7606 (1960), p. 248-52.
5. R. Dams and J. Hoste, *Anal. Chim. Acta* **39**, 423 (1967).
6. J. P. M. Houtman and J. Turkstra, Symposium on Radiochem. Methods of Analysis, Salzburg, 1964, Preprint SM-55/91, Vienna, IAEA.
7. J. P. M. Houtman and J. Turkstra, National Conference on Nuclear Energy; Application of Radioisotopes and Radiation, Palindaba, South Africa, Atomic Energy Board 1963.
8. F. Kukula and M. Krivanek, *Isotopenpraxis* **4**, 57 (1968).
9. Lobanov, Romanov, and Khaidanov, *Radiatsionnye Effekty v Kondensirovannykh Sredikh*, Publishing House of Sciences, Tashkent (1964), p. 111-15.
10. W. A. Jester and E. E. Klaus, *Trans. Am. Nucl. Soc.* **9**, 589 (1966).
11. Rausch, Czada, and Szabo, *Chem. Zvesti* **21**, 592 (1967).
12. Ruzicka, Stary, and Zeman, *Zhur. Analit. Khim.* **19**, 932 (1964).
13. J. Stary and J. Ruzicka, *Talanta* **11**, 697 (1964).

## 2. Other Nuclear Methods

## a. Neutron Absorptiometry

The property of strong absorption for thermal neutrons of some elements has not been generally accepted in spite of the relatively simple experimental requirements. For comparison, the thermal neutron capture cross sections<sup>2</sup> of some selected elements are listed in Table XXXIX.

It should be noted that the most abundant elements have very low capture cross sections for thermal neutrons and thus do not interfere with analytical methods based on neutron absorption. However, it should also be kept in mind

TABLE XXXIX. Thermal neutron capture cross sections of selected elements.

Element	Barns	Element	Barns	Element	Barns	Element	Barns
Gd	47,000	Ir	460	Lu	80	Al	0.23
Sm	5,800	Hg	360	Au	99	P	0.19
Eu	4,300	In	194	Re	85	Si	0.16
Cd	2,390	Rh	150	Li	71	Mg	0.06
Dy	940	Tm	125	Ho	65	F	0.10
B	759	Hf	105	Ag	63	O	0.0002

that the scattering cross section for light elements can be an appreciable fraction of the total reaction cross section and should be taken into consideration when materials for calibration curves are selected.

Macro amounts of mercury have been determined by neutron absorptiometry in matrices such as dry mercury bearing minerals,<sup>181,188-190</sup> solutions,<sup>189-191</sup> and flotation pulps.<sup>188-191</sup> A comparison of the neutron-absorption method of determining mercury with standard chemical methods showed that the absolute error between the two methods never exceeded 0.2 percent. Appreciable errors can arise when other elements with high capture cross sections for thermal neutrons are present in the sample. Such elements which tend to accompany mercury in geological formations are lithium, antimony, and arsenic. The error introduced in a mercury determination by the presence of one interfering element can be estimated with the equation

$$(C \cdot A \cdot \sigma)_{\text{Interf.}} = (C \cdot \sigma \cdot A)_{\text{Hg}}$$

where C are the concentrations, A the atomic weights, and  $\sigma$  the thermal neutron capture cross sections of the interfering element and mercury, respectively.

#### b. Isotopic Dilution

Analysis by isotopic dilution is based on the variation of the specific activity of an added tracer isotopic with the element to be determined as

the result of dilution by the inactive element. In the case of mercury, a dithizone extraction of Hg from the unknown-plus-tracer solution, an extraction from the tracer solution, and counting of equal volumes of each extract gives the initial and final specific activities required to compute the concentration of Hg present in the unknown.

Ruzicka and Stary<sup>192</sup> describe a procedure for the measurement of Hg concentrations in the range 1 to  $10^{-4}$   $\mu\text{g/liter}$ . The maximum sensitivities obtainable by other analytical methods<sup>193</sup> are summarized in Table XL for comparison

TABLE XL. Comparison of sensitivities of several analytical methods.

Method	Maximum Sensitivity in gram Hg/liter
Flame Photometry	$10^{-4}$
Copper Spark	$5 \times 10^{-6}$
Graphite DC Arc	$2 \times 10^{-6}$
Neutron Activation ( $10^{13}$ n/cm <sup>2</sup> /sec)	$6 \times 10^{-9}$
Isotopic Dilution	$10^{-10}$

Isotopic dilution analysis has been used to measure mercury traces in rice.<sup>194</sup>

### c. Backscattering of Beta Radiation

When a beam of electrons strikes a piece of matter, an appreciable number may be reflected as a result of single and multiple scattering processes with the nuclei and electrons of the reflector. The intensity of the reflected electrons increases with increasing thickness of the scatterer. For thicknesses greater than approximately one third of the range of the electrons, saturation scattering is achieved. A further increase in thickness does not contribute anything to the intensity of the

reflected electrons. The ratio of the measured activity of a beta source with reflector to that without reflector is called the backscattering factor and is virtually independent of the maximum beta energy for energies greater than 0.6 MeV. Both, the intensity of the scattered electrons,  $I_s$ , and their maximum energy after the scattering process,  $E_s$ , are functions of the atomic number of the scatterer and can be estimated from the empirical<sup>195</sup> equations:

$$I_s = A \cdot I_o \cdot Z^{2/3}, \text{ and}$$

$$E_s = B \cdot E_o \cdot Z^{1/3},$$

where  $Z$  is the atomic number of the scattering nuclei,  $I_o$  the intensity of the incident electrons,  $E_o$  their maximum energy, and  $A$  and  $B$  are geometry coefficients. In multicomponent mixtures, the element to be determined should be 15-20 units of  $Z$  greater than the remainder of the components. As beta sources  $Tl^{204}$  ( $E_{max}$  -0.76 MeV),  $Sr^{90}-Y^{90}$  ( $E_{max}$  -2.18 MeV), and  $Ru^{106}-Rh^{106}$  ( $E_{max}$  -3.51 MeV) have been used. In practice, once a suitable geometry for the measurement has been established, a calibration curve relating percent reflected intensity with mercury concentration is generated. Provided the atomic numbers of the elements accompanying mercury are about 15 units less than 80, the calibration curve should be a straight line over a wide concentration range. This method has found limited use to measure mercury concentrations in pharmaceutical preparations<sup>196</sup> and in ore enrichment products.<sup>188,197</sup>

### 3. Counting

An examination of Table XXVII shows that  $Hg^{197,197m}$  and  $Hg^{203}$  are the products which permit the measurement of mercury concentrations with the highest sensitivity. Indeed these nuclides are generally used for activation analyses. In the following discussion counting methods for these nuclides will be treated in some detail. Although the decay schemes

of  $\text{Hg}^{197,197m}$  and  $\text{Hg}^{203}$  are presented in Table II, it may be useful to summarize briefly their predominant features.

#### Mass 197

(a) About 97 percent of all  $\text{Hg}^{197m}$  nuclei formed in an irradiation undergo an isomeric transition to  $\text{Hg}^{197}$  under emission of 0.134 MeV and 0.164 MeV gamma rays which are internally converted to 66 percent and 92.5 percent, respectively. The result of this internal conversion process is the emission of Hg K X-rays of an average energy of 68 KeV.

(b) The nuclide  $\text{Hg}^{197}$  decays to 98 percent by electron capture to the first excited state of  $\text{Au}^{197}$  which results in the emission of Au K X-rays. The excited  $\text{Au}^{197}$  nuclei then decay to their ground state by emission of a 77 KeV gamma ray.

In order to measure the mixture  $\text{Hg}^{197m}$  and  $\text{Hg}^{197}$  by gamma spectrometry, only the region between 0 and 150 KeV is of interest. Examples of gamma spectra of  $\text{Hg}^{197m} + \text{Hg}^{197}$  and  $\text{Hg}^{197}$  are presented in Figures 38 and 39, respectively.<sup>198</sup> Among other things, these spectra show that a NaI (Tl) detector cannot resolve the 68 KeV and 77 KeV peaks. It may be instructive to compute the number of gamma and X-ray quanta with energies in the 68-77 KeV region produced in 100 disintegrations of each of the nuclides  $\text{Hg}^{197m}$  and  $\text{Hg}^{197}$ . The necessary data<sup>199,200</sup> are summarized in Table XLI. At an atomic number of 80, the electron capture proceeds to about 86 percent via K capture; the remainder is mostly L capture. The fluorescence yield is 96 percent at  $Z \approx 80$ , so that 82 K X-rays are emitted per 100 electron capture processes.<sup>201,202</sup> The total number of quanta emitted by  $\text{Hg}^{197m}$  and  $\text{Hg}^{197}$  per 100 disintegrations in the energy range 68-77 KeV then is for  $\text{Hg}^{197m}$ :  $[(3 \times 0.86 \times 0.96) + 20.7 + 15.5] = 38.7$ , and for  $\text{Hg}^{197}$ :  $[(99 \times 0.86 \times 0.96) + 0.5 + 29] = 111.2$ .

In order to estimate a realistic detection limit for mercury one should take into consideration the following three factors which cause a decrease of the photo peak count rates:

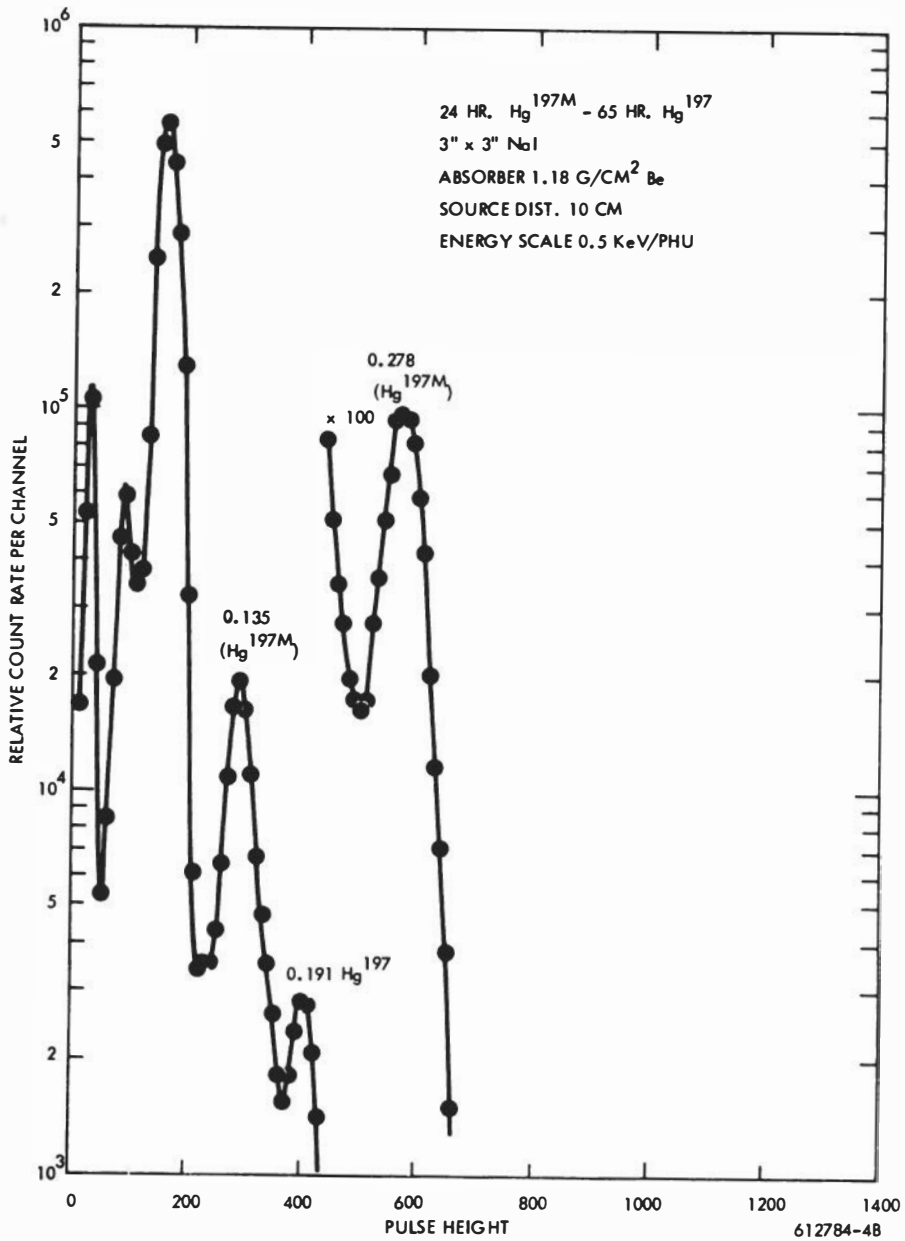

Figure 38. Gamma spectrum of the parent-daughter pair 24-hour  $\text{Hg}^{197\text{m}}$ -65-hour  $\text{Hg}^{197}$ .

Figure 39. Gamma spectrum of 65-hour  $Hg^{197}$ .

TABLE XLI. Low energy X- and gamma rays from Hg<sup>197m</sup> and Hg<sup>197</sup>.

Nuclide	Gamma Energy (MeV)	Percent Unconverted	No. of K X-rays Per Gamma Ray	No. of 68-77 KeV Quanta per 100 Disintegrations
Hg <sup>197m</sup>	0.164	4.5	4.6	20.7
	0.134	31	0.5	15.5
Hg <sup>197</sup>	0.192	0.5	1	0.5
	0.077	29	0	29

(a) The efficiency of NaI (Tl) detectors for 60-80 KeV gamma quanta which is estimated<sup>203,204</sup> to be of the order of 40 percent provided the standard size of 3 inch diameter x 3 inch thick is used. However, Morris and Killick<sup>153</sup> pointed out, that an improved photo peak-to-Compton background ratio can be realized with a thin (0.25 in. thick) NaI (Tl) detector. High energy (>150 KeV) gamma quanta have a much lower probability of interacting with the NaI (Tl) detector than low energy gamma rays. In general thin NaI (Tl) detectors will be advantageous where low energy gamma rays are to be counted in the presence of high energy gamma quanta.

(b) When gamma quanta in the 33-150 KeV range are counted with a NaI (Tl) detector, for energy photo peak of energy E, an "escape peak" of energy (E-28.6 KeV) appears in the spectrum, resulting in a slight lowering of the photo peak counting rate. This reduction becomes more appreciable, the closer the energy of the photo peak approached the absorption edge of iodine at 33.6 KeV. For the case of Hg<sup>197</sup> and Hg<sup>197m</sup>, this effect has been estimated to be about 10 percent.<sup>205</sup>

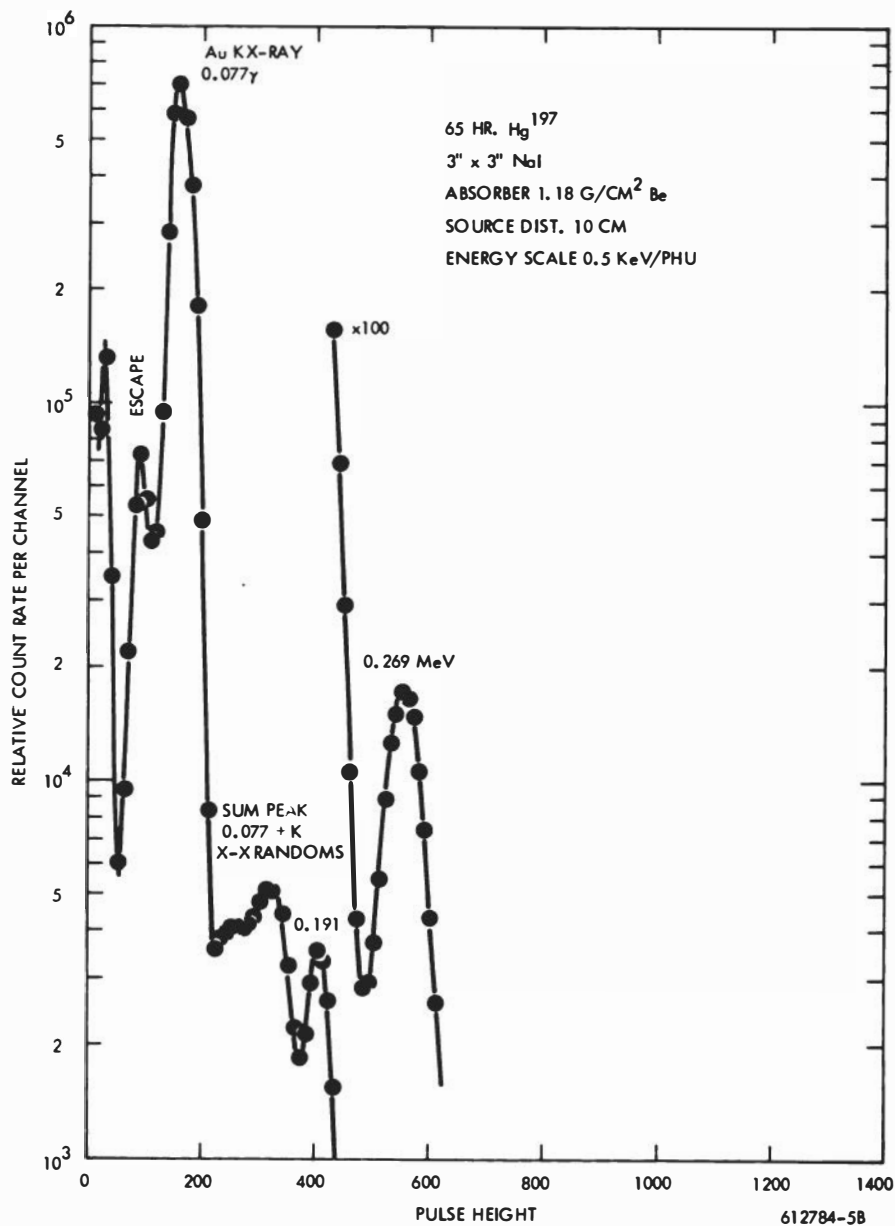
The total photo peak efficiency as well as the photo peak efficiency without any escape peak interference has been computed by Gorski.<sup>206,207</sup>

(c) A chemical recovery of less than 100 percent clearly means a further reduction in activity. An alternative way of measuring Hg<sup>197</sup> and Hg<sup>197m</sup> would be by X-ray counting using a Xe-filled proportional counter.<sup>155,208</sup> The dimensions and the pressure inside such a counter can be chosen to



assure almost complete absorption of the X-rays. However, the appreciably lower efficiency for X-rays in the 60-80 KeV range of the proportional counter makes a thin NaI (Tl) detector a better choice.

### Mass 203

Of lesser importance for activation analysis, but possibly more useful for tracer studies is the 47-day  $\text{Hg}^{203}$ . This nuclide decays to an excited state of  $\text{Tl}^{203}$  by emission of 0.208 MeV beta particles. The excited  $\text{Tl}^{203}$  then decays to its ground state by emission of a 0.279 MeV gamma ray. The decay scheme of  $\text{Hg}^{203}$  is very well known and suggests measurement of this nuclide either by beta or gamma counting. Again, gamma counting is preferable over beta counting, since no corrections for self-absorption, absorption in air and counter window, and for back-scattering are necessary. A typical gamma spectrum of  $\text{Hg}^{203}$  is presented in Figure 40.

For counting methods of other mercury isotopes the reader is referred to papers describing their formation. An initial source for such references are the tables by Lederer, Hollander and Perlman.<sup>1</sup>

## V. DISSOLUTION METHODS

Mercury is completely volatilized when its compounds or substances containing the element are ignited or fused with  $\text{Na}_2\text{CO}_3$  or  $\text{Na}_2\text{O}_2$ . Mercury is partially volatilized when solutions containing its salts, particularly  $\text{HgCl}_2$ , are boiled or evaporated on a steam bath. The amount of mercury lost when a mercury solution is evaporated to dryness on a steam bath appears to depend more on the shape of the vessel than on the concentration of mercury in the solution.<sup>204</sup> However, experience has shown<sup>153</sup> that inorganic samples such as rocks or meteorites can be dissolved in concentrated HF and in the presence of Hg carrier on a steam bath without loss of mercury activity before the exchange with the Hg carrier was complete.

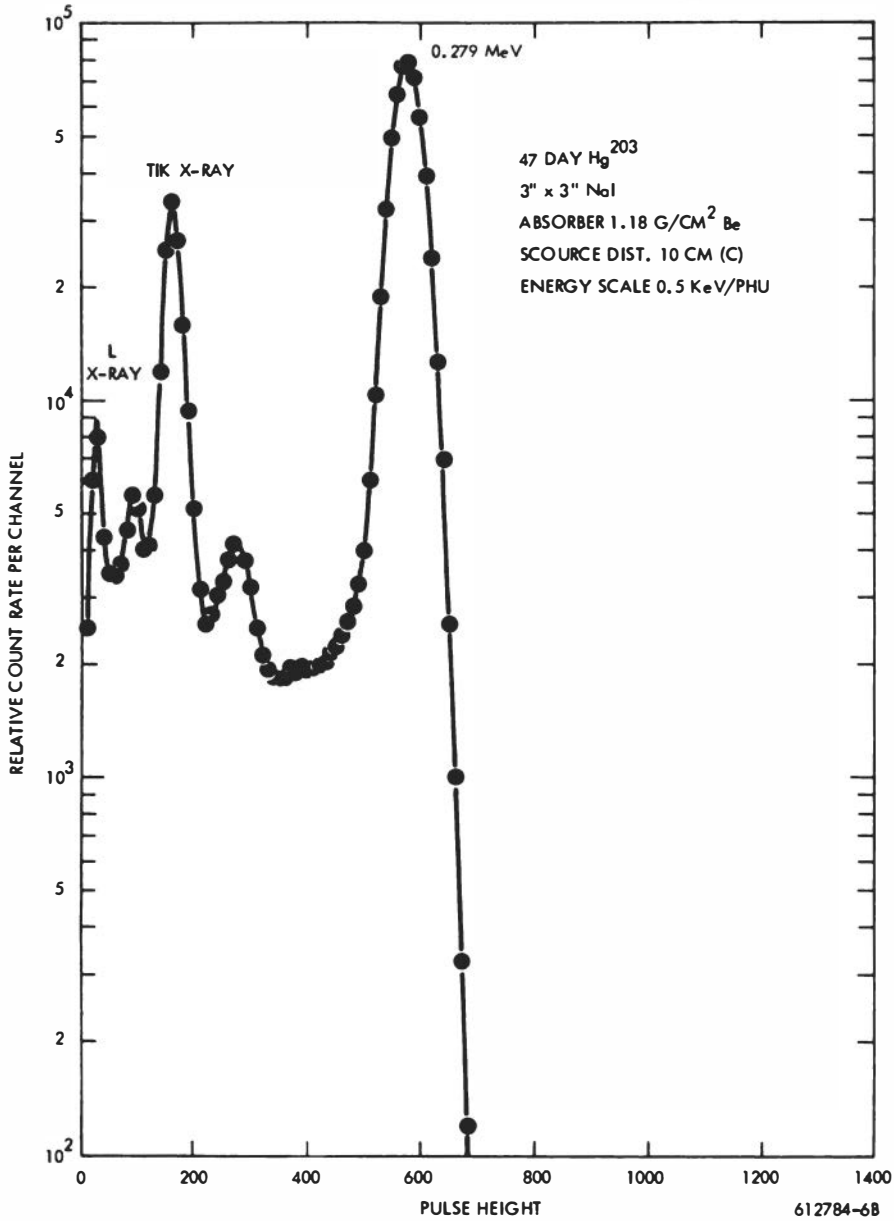

Figure 40. Gamma spectrum of 47 day  $Hg^{203}$ .

During the wet oxidation of organic materials, variable amounts of mercury are always lost because of the high volatility of the element and its compounds. The amounts of mercury lost under a variety of heating conditions are presented in Figure 41, taken from Gorsuch's thorough study on the recovery of trace elements in organic and biological materials.<sup>210</sup>

In order to measure true mercury concentrations in organic substances, complete decomposition of the organic matter is a must. Incomplete decomposition is undesirable since mercury combines readily with organic radicals to form volatile and covalent compounds which will lead to incomplete extraction at a later stage in the separation procedure.

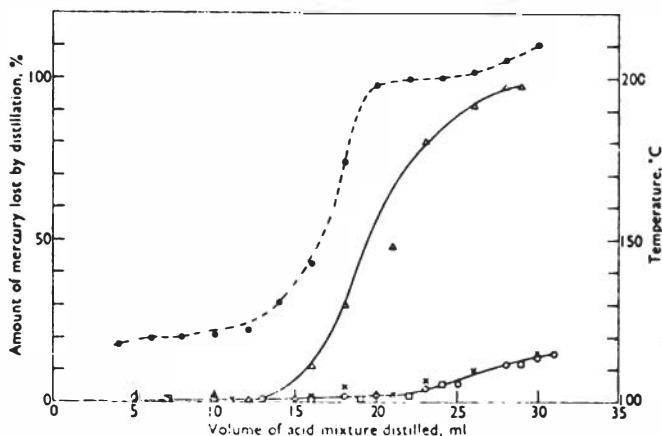

Figure 41. Loss of mercury by distillation when acid mixture was heated under different conditions; X, acid mixture alone; O, acid mixture with 1 ml of concentrated hydrochloric acid; □, acid mixture in stream of carbon dioxide; Δ, acid mixture with 0.5 g of glycine. The broken line curve, O, is the temperature-volume distilled curve for the nitric-perchloric-sulphuric acid mixture.

Gorsuch<sup>210</sup> suggested a very efficient method for the wet oxidation of organic matter in a closed system in which mercury is retained quantitatively and which is reproduced below: "... as mercury has been shown to distill from systems containing perchloric acid and organic matter, it is obviously necessary to make some provision for the collection of the distillate. This is achieved by using the apparatus shown in Figure 42. With this apparatus, a liquid heated in the flask would reflux through tap A, reservoir

B and the condenser. If the tap were then turned through  $90^{\circ}$ , the distillate would rise up the side connection D, condense, and fall into the reservoir, where it would be retained. A further  $90^{\circ}$  turn of the tap would allow the

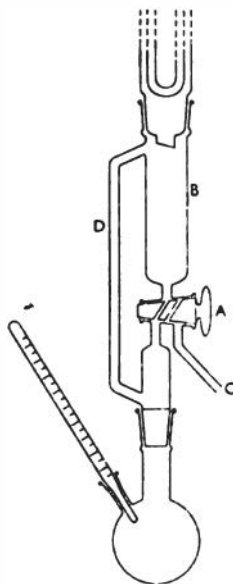

Figure 42. Apparatus for controlled decomposition of organic material.

condensate to run out through side-arm C. If a diluted mixture of nitric, perchloric and sulphuric acids were heated, with the tap in the second position, nitric acid and water would distill into B; this would cause the temperature of the solution remaining in the flask to rise. The whole system can be stabilized at any particular temperature by running the condensate out of B and turning the tap to the reflux position. The oxidation potential can thus be steadily increased or held constant ... "

Pijck, Hoste, and Gillis investigated the losses of selected trace elements during mineralization of organic material and found that on the average less than 5 percent of mercury could be recovered after heating the samples to  $400^{\circ}\text{C}$  for 24 hours.<sup>211</sup>

#### VI. COLLECTION OF DETAILED RADIOCHEMICAL PROCEDURES FOR MERCURY

In the following, detailed procedures are presented for the separation of mercury activities from various matrices ranging from ultrapure metals to

biological samples. The procedures are arranged, quite arbitrarily, according to the method of separating mercury from the matrix into radiochemical methods (Procedures 1-20), volatilization (Procedures 21-30), electrochemical displacement (Procedures 31 and 32), isotopic dilution (Procedures 33 and 34), radiometry (Procedure 35), isotopic exchange (Procedure 36), and lastly, a colorimetric method (Procedure 37), recommended for standardizing carrier solutions.

#### PROCEDURE 1.

##### A Neutron-Activation Study of the Solubility of Mercury in Water

Source: S. S. Choi and D. G. Turk, J. Chem. Soc. (London) 1962, p. 4080.

##### Standard Solution

A standard solution was prepared by dissolving 0.24220 g of mercuric chloride in 250 ml of distilled water, then diluting 5 ml to 100 ml with dilute sulfuric acid; acid is necessary to prevent adsorption by the glass<sup>212</sup> and the only relevant work<sup>23</sup> reports that sulfuric acid contains less mercury as impurity than do the other mineral acids. The final solution contained 48.44  $\mu\text{g/ml}$ ; its density at 25 °C was 0.9914 g/ml.

By a technique similar to that described below, 1 drop of freshly prepared solution was transferred to a weighed silica irradiation phial of 4 mm diameter, and the weight of solution in the phial was determined. Distilled water was then added to dilute the solution in the phial (-10-fold), and to give a depth of solution approximately the same as in the phials containing solution samples. The phial was subsequently sealed and treated in the same way as the solution samples. The dilution of the standard solution was necessary for two purposes. First, attenuation of the neutron flux is reduced, since self-shielding falls off exponentially with decreasing concentration and should be negligible with the diluted solution. Secondly, any differences in the effective neutron flux received by sample and standard, due to inhomogeneity, are minimized by keeping the depth of solution the same in both cases.

### Sampling, Packing, and Neutron Bombardment

Great care was taken to avoid contamination during sampling, especially since laboratory air normally contains appreciable quantities of mercury vapor<sup>23</sup> and since mercury is strongly adsorbed on glass.<sup>212</sup> To avoid the first difficulty the thermostat-baths were placed in an office room where chemicals were not handled. The silica irradiation phials were prepared in advance, cleaned as described above, and heated to red heat to drive off adsorbed material, and both ends were then sealed until required. The tubes, and similarly treated silica sampling pipettes, were stored in a desiccator until required.

Immediately before sampling, three phials were opened and a thin silica funnel was inserted in the neck of each to prevent liquid wetting the neck during the filling. The sampling pipette was meanwhile opened and placed in a silica guard-tube heated electrically to a temperature slightly above that of the solution in question. The solution vessel was next raised to be half-immersed in the thermostat-bath and the top was broken off at a previous knife-mark; the sampling pipette was washed through with solution, which was rejected, and an appropriate volume of solution was transferred to the phial, which was cooled in ice. The phial was then quickly sealed. The whole operation needed about 1 minute. The weight of solution was determined later. Two samples were taken from each solution; the third phial contained distilled water to provide a control test of the sampling procedure.

All the sealed phials were tested by heating at 100 for 24 hours, and then packed in the standard aluminum irradiation can. Each can contained 2 pairs of samples and a pair of standards, as well as 2 control tests with sufficient silica wool to prevent movement. As far as possible, each phial was placed symmetrically in the can with respect to its duplicate. Calculations based on the equation given by Hughes<sup>157</sup> showed that flux depression should be negligible under these conditions.

The solutions were irradiated for approximately 1 week in BEPO at pile factor 12. No phials burst. After transport to the laboratory, the cans

were left for 1-1/2 days to cool; the phials were then removed, washed extensively with alcohol and water, and finally immersed overnight in aqua regia. The phials were again thoroughly washed with water before chemical treatment.

#### Chemical Separation of Radioactive Mercury

Although  $\gamma$ -ray spectrometry was used in the counting, the presence of foreign activities with energies similar to those being detected is always possible. For example, Leliaert<sup>213</sup> has shown that appreciable activities may arise from the impurities present in the silica. Chemical separation of the active mercury was therefore carried out before counting.

The phial (either standard or sample) was first centrifuged to collect all the liquid at the bottom of the tube, and the solution then frozen in liquid air before being broken open. This freezing was necessary because of the considerable pressure (at room temperature) of the gaseous radiolysis products. Both parts of the broken phial were placed in a flask containing inactive mercury carrier (15 mg for solution, 30-45 mg for standard) in 3.5M-nitric acid. The phial was completely covered with acid (~15 ml) which was forced into any empty spaces with a dropper; all washings were returned to the flask, whose contents were gently refluxed for 1 hour. This treatment completely removed active mercury from the phial, and also ensured that active and carrier mercury had the same chemical form. The broken pieces of the phial were removed, and the washings, and those from the condenser, were added to the flask. Since nitric acid does not attack silica, this treatment should not bring any foreign activities into solution.

Hydrogen sulfide was passed through the solution for about 1 hour, precipitating mercuric sulfide; the solution was warmed on a water-bath during the early part of this period. Oxidation of the precipitate by nitric acid does not occur if hydrogen sulfide is always present in excess.<sup>212</sup> The precipitate was finally collected by centrifugation and washed twice with 2M-hydrochloric acid. The precipitate was dissolved in a few drops of aqua regia; 3 ml of concentrated hydrochloric acid were added to this solution and

the mixture evaporated almost to dryness to remove nitric acid. 2M-hydrochloric acid (20 ml) and silver nitrate solution (1 mg of  $\text{Ag}^+$  per ml; 5 ml) were added; this silver chloride precipitation scavenges out any foreign activities, and also removes any colloidal sulfur present. This scavenging was repeated; and mercuric sulfide then precipitated from the dilute hydrochloric acid solution.

The centrifuged precipitate was washed (twice with dilute hydrochloric acid, twice with water, once with acetone), and the acetone slurry was filtered through a constant-weight glass-wool filter paper (Waterman glass paper, W. and P. Balston Ltd.). Each filter was dried at  $105^\circ$  for 1-1/2 hour in a separate Petri dish to prevent cross-contamination; in addition, a similar weight of inactive mercuric sulfide was dried at the same time to check for possible contamination in the drying process. The chemical yield of mercury was obtained from the weight of the dry precipitate. The filter paper and precipitate were mounted on an aluminum counting tray with a few drops of Perspex solution; after this had evaporated, the sample was covered with Sellotape.

### $\gamma$ -Ray Spectrometry

The counter consisted of a 1" x 1" NaI (Tl) crystal and photomultiplier tube coupled via a linear amplifier to either a "Philips" single-channel pulse-height analyzer, or a 50-channel analyzer. The radiochemical purity of each precipitate was checked by recording its  $\gamma$ -ray spectrum in the 30-300 keV region with the 50-channel analyzer, and by comparing this with the spectrum of  $\text{Tm}^{170}$ , with photo peaks at 84 ( $\gamma$ ) and 49 (X-ray) keV. A typical spectrum, reproduced in Figure 43, shows the 68-77 keV photo peak broadened on the low-energy side; the resolution is ~25%. The Compton scattering from higher-energy radiation is negligible in this region.

The final activity measurement involved counting the pulses in the 68-77 keV band by using the single-channel analyzer. The samples were placed about 0.4 cm from the front surface of the crystal. At least  $1.5 \times 10^4$  counts were recorded for each sample, thus reducing the statis-



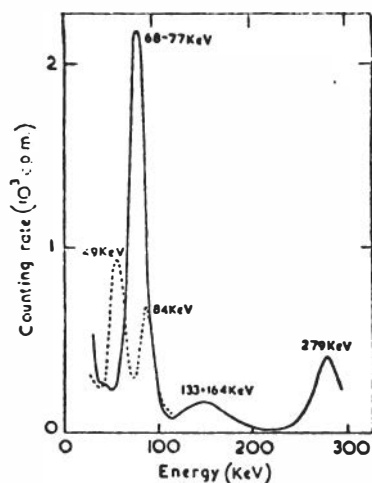

Figure 43.  $\gamma$ -Ray spectrum of Hg<sup>197+197m</sup> (full line), and of Tm<sup>170</sup> (broken line).

tical error to below 1 percent. This number of counts could be recorded in a time sufficiently short that no decay correction for decay was necessary.

#### PROCEDURE 2.

The Determination of Mercury in Rocks by Neutron Activation Analysis.

Source: O. F. C. Morris and R. A. Killick, *Talanta* 11, 781 (1964).

#### Irradiation

About 0.8 g samples of rock were accurately weighed and sealed in cylindrical aluminum capsules of 6 mm diameter. Standards were prepared by weighing out 0.1 ml aliquots of a dilute standard solution of mercuric nitrate (50 mg of Hg/liter) into silica tubes of 4 mm internal diameter. The silica tubes were sealed with a burner, the lower parts being cooled to avoid any possibility of losses by evaporation. Containers of samples and standards were packed together with silica wool in a standard 1 inch diameter x 3 inch long screw-top aluminum can, and sent to Harwell for irradiation. Irradiations were for 6 days in a nuclear reactor at a thermal flux of  $1.2 \times 10^{12}$  n/cm<sup>2</sup> sec.

### Radiochemical Separation

Because of the complex nature of rocks, non-destructive analysis using scintillation spectrometry was impossible. On the other hand, a simple radiochemical procedure for separating mercury from other contaminants was easily developed. Experimental details are as follows.

Step 1: Remove the irradiation capsules containing portions of rock from the can, open them, and transfer the samples to 60 ml platinum crucibles, each containing 1 ml of standard mercury carrier [10 mg of Hg/ml as mercuric nitrate in 1 M nitric acid; standardized gravimetrically with bis(ethylene-diamine) copper (II) tetra-iodomercurate (II)]. Wash out the capsules with a little warm 6 M nitric acid and transfer the washings quantitatively to the crucibles (Note 1).

Step 2: To each sample add 10 ml of 40 percent hydrofluoric acid, cover the crucible loosely with the platinum lid, and digest on a steam-bath until the sample has completely dissolved. Add 3 ml of 9 M perchloric acid and 2 ml of 16 M nitric acid, and heat the mixture till white fumes of perchloric acid begin to be given off, taking care to avoid spattering. Replace the cover loosely, and continue to heat for about 5 minutes at a temperature at which the perchloric acid fumes moderately but does not rapidly evaporate. Heat for 5-10 minutes longer and finally evaporate carefully almost to dryness (Note 2).

Step 3: Transfer the residue with 10 ml of water to a 50 ml centrifuge tube. Add 5-6 drops of 20% stannous chloride solution. Centrifuge and discard the supernate. Wash the precipitate of mercury (I) chloride thoroughly with water and ethanol. Discard the supernates.

Step 4: Slurry the mercurous chloride with acetone and transfer to the bottom of a long cold-finger condenser packet (17 x 2 cm) using a long-tipped dropping pipette for the purpose. Evaporate the acetone with gentle heating. Cover the solid mercurous chloride with powdered iron, and insert the cold finger. Apply increasing heat from a microburner, and maintain the flame for a few minutes to drive all the mercury onto the tip of the cold

finger (Note 3). Allow to cool completely before removing the jacket and replacing it with another containing 6 drops of 12 M hydrochloric acid and 4 drops of 16 M nitric acid. Gently distill the acid onto the finger (water flow now shut off) until the gray film of mercury is dissolved. Cool again and dismantle, rinsing the cold finger thoroughly as it is withdrawn.

Step 5: Transfer the acid solution from the outer jacket to a 50 ml centrifuge tube. Wash thoroughly with water and add the washings to the contents of the centrifuge tube. Make the resulting solution faintly ammoniacal and add 5 ml of 2 percent potassium iodide solution. Heat on a steambath and add, dropwise, a hot concentrated aqueous solution of bis(ethylenediamine) copper (II) nitrate. Allow to cool to room temperature. Centrifuge, wash the precipitate several times with a solution containing 0.2 g of KI and 0.2 g of  $[\text{Cu en}_2] (\text{NO}_3)_2 \cdot 2\text{H}_2\text{O}$  in 200 ml of water, and then with ethanol. Slurry the precipitate with ethanol onto a weighed aluminum counting tray and dry under an infrared lamp. Cool and weigh to determine the chemical yield (usually -80 percent).

#### Treatment of Irradiated Mercury Standards

At a suitable time open the silica irradiation tubes containing the mercury standards. Using a transfer pipette drawn out almost to a point, transfer the irradiated mercury solution quantitatively to a 50 ml volumetric flask. Make up to the mark with 3 M nitric acid. Transfer a 10 ml aliquot to a 50 ml centrifuge tube containing 1 ml of standard mercury carrier. Precipitate  $[\text{Cu en}_2][\text{HgI}_4]$ , mount, dry and weigh it as described in Step 5 of the procedure for rock samples.

#### Notes

(1) Where pieces of rock, as opposed to powdered samples, are irradiated, remove surface contamination by cleaning with warm 6 M nitric acid. After attack of the cleaning solution has proceeded for 1.5 minutes, remove the portion of rock and wash it thoroughly with water.

(2) When an irradiated standard was put through Steps 1 and 2 of the radiochemical procedure, it was found that no loss of radiomercury occurred before exchange with carrier had been achieved.

(3) The vapor pressure of mercury at 400 °C is 2.07 atm.

### Activity Determination

The electromagnetic radiation from  $\text{Hg}^{197}$  in final precipitates from samples and standards were measured at constant geometry by scintillation spectrometry. A thin (3 inch diameter x 0.25 inch thick) NaI (Tl) crystal with a beryllium window was used as a detector to reduce the effect of any high-energy gamma radiation. The  $\text{Hg}^{197}$  spectrum was generally studied after 3 days from the end of irradiation in the region 0-150 keV. This region is lower than the Compton distribution resulting from any higher-energy gamma rays, and the background is relatively low and flat. With the present technique the 68-keV X-rays and 77-keV gamma rays could not be resolved. The activity of  $\text{Hg}^{197}$  was determined from the area under the composite peak. Background correction was made by extrapolation of the Compton contribution. This method of subtraction proved practical and reproducible, although a more refined method could possibly be devised. A self-absorption correction curve, prepared in the conventional manner by precipitating different amounts of  $[\text{Cu en}_2][\text{HgI}_4]$  with fixed amounts of mercury, showed that with the range of weights of precipitates obtained from the radiochemical procedure count rates could be compared directly. A total photopeak area of 100 cpm was considered to be the practical limit of detection.

### PROCEDURE 3.

$\text{Hg}^{206}$  As a Branching Member of the Uranium Series

Source: Wolf, Lux, and Born, *Radiochimica Acta* 3, 206 (1964).

### Procedure

This separation procedure is carried out in a glove box which should be kept under a slight negative pressure and which should have a clean

(uncontaminated) access port. A nitric acid solution of RaD, RaE, and RaF ( $\text{Pb}^{210}$ ,  $\text{Bi}^{210}$ , and  $\text{Po}^{210}$ ) is pipetted in an evaporation apparatus which is closed toward the atmosphere by means of a NaOH wash bottle and a charcoal filter. The solution is slowly and carefully brought to dryness, then taken up by gentle warming in about 2.5 ml of 0.5N  $\text{HNO}_3$  and transferred in an Erlenmeyer flask for neutralization. The pH of this solution, measured with a glass electrode, is adjusted to 2.6 with dilute NaOH.

#### Preliminary Separation of RaE and RaF

A mercuric oxide bed, about 2 cm in diameter and 2 cm high (~12 g yellow  $\text{HgO}$ ) is washed with water, acidified with  $\text{HNO}_3$  to a pH of 2.6, until the effluent has a pH of 3 at a flow rate of 0.5 to 1 ml/minute. The neutralized RaD, E, F solution is transferred from the Erlenmeyer flask to the  $\text{HgO}$  bed and filtered through it under vacuum. The filtrate is set aside and may be worked up later since it contains small amounts of RaD ( $\text{Pb}^{210}$ ). The bulk of RaD, about 95 percent, is washed from the  $\text{HgO}$  bed with water, acidified with  $\text{HNO}_3$  to a pH of 2.6. The collection flask under the  $\text{HgO}$  bed contains 20 mg of  $\text{Hg}^{+2}$  carrier in 0.3 ml glacial acetic acid. The remainder of the RaD is washed from the bed with 5 ml of water (pH 2.6) and set aside to be worked up later.

#### Separation of $\text{Hg}^{206}$ from RaD and from Small Amounts of RaE, RaF, RaE".

To the solution which contains the bulk of RaD and Hg carrier, 10  $\mu\text{g}$   $\text{Ba}^{++}$  is added followed by 1 ml of a 5 percent NaCl solution and 0.1 ml saturated Na-acetate solution. The mixture is allowed to stand to let  $\text{Hg}^{206}$  grow in RaD.

In order to perform rapidly the following separation steps, five "filtration elements" were connected in series. One such filtration element is shown in Figure 44.

The initial precipitate is transferred to a frit and dried under vacuum. By opening slightly the lower stopper, air enters the frit and swirls up the precipitate. Through sidearm b, fresh carrier and reagents

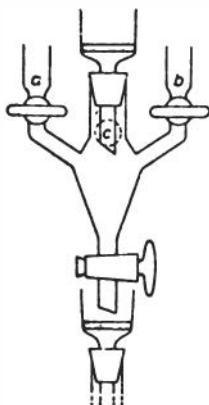

Figure 44. Filtration Element; a, b, sidearms for the addition of reagents, c to be connected to a vacuum line.

are admitted to the filtrate. After thorough mixing, more precipitant is added through sidearm a. After precipitation and venting, solution and precipitate are allowed to reach the frit of the following filtration element where above process is repeated.

#### Step 1

To the aged RaD solution, 0.3 ml of a 5 percent solution of  $\text{Na}_2\text{Cr}_2\text{O}_7 \cdot 2\text{H}_2\text{O}$  is added, mixed thoroughly, and RaD is precipitated. The mixture, solution and precipitate, are transferred to the filtration apparatus described above and filtered through a glass frit.

#### Step 2

To the filtrate from step 1, 10  $\mu\text{g}$  of  $\text{Ba}^{++}$  and 0.2  $\mu\text{g}$  of  $\text{Pb}^{++}$  in 0.3 ml of 2N acetic acid and 0.1 ml of a 5 percent solution of NaCl are added. The solution is mixed by bubbling air through it. Through the second sidearm 0.25 ml of  $\text{Na}_2\text{Cr}_2\text{O}_7$  solution is added and after thorough mixing is filtered through a membrane filter into a second filtration element.

#### Step 3

Repeat Step 2.

#### Step 4

In the third filtration element, 8  $\mu\text{g}$  of  $\text{Bi}^{+3}$  carrier in 0.3 ml of concentrated HCl are added to the filtrate and mixed; through one sidearm

15 mg KCN in 0.5 ml water are added. The cyanide ions form with  $\text{Hg}^{++}$  undissociated  $\text{Hg}(\text{CN})_2$ . Through the second sidearm 250  $\mu\text{g}$  of  $(\text{NH}_4)_2\text{HPO}_4$  in 1 ml of water is added to precipitate  $\text{BiPO}_4$ , which carries the RaE ( $\text{Bi}^{210}$ ). The mixture is filtered through a membrane filter.

### Step 5

A solution of 100  $\mu\text{g}$   $\text{SnCl}_2$  in 1 ml of concentrated HCl is placed inside the fourth filtration element. As soon as this solution is mixed with the filtrate from Step 4,  $\text{Hg}_2\text{Cl}_2$  precipitates which is filtered through a fine filter paper. The precipitate is washed twice with 1 ml of 2 N HCl and twice with 1 ml of alcohol-ether, then removed from the glove box, dried for 30 seconds with hot air, and counted.

The time required from first filtration to the beginning of the counting is about 5 minutes, the chemical recovery of mercury is of the order of 50-70 percent. For clarity, the entire separation scheme is diagrammed in Figure 45. Some important decontamination factors are listed in Table XLII.

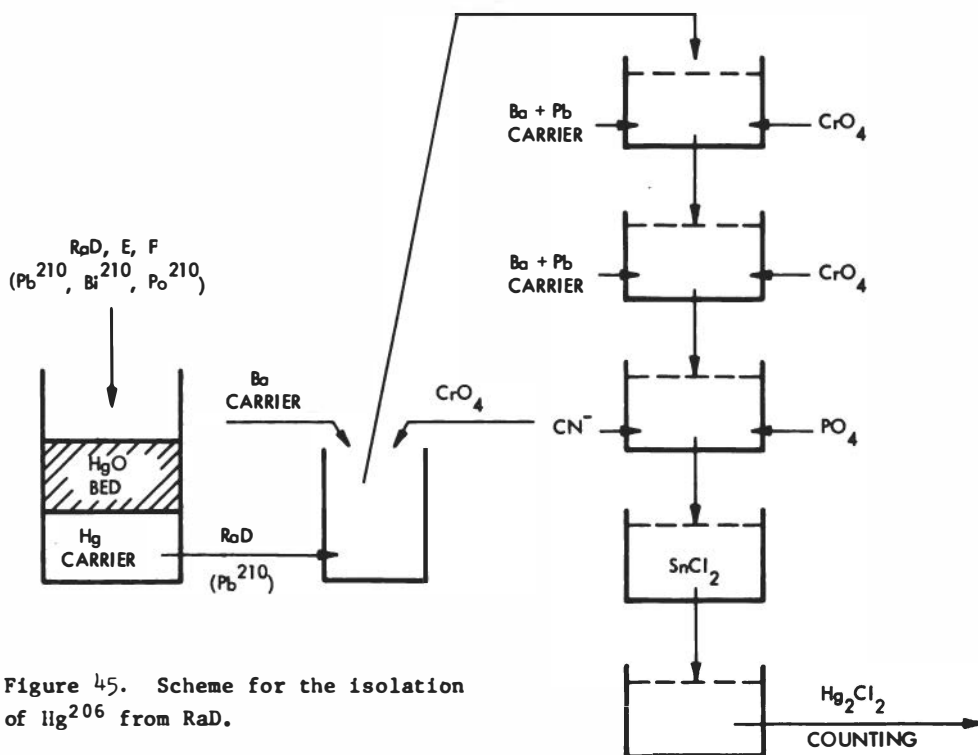

Figure 45. Scheme for the isolation of  $\text{Hg}^{206}$  from RaD.

TABLE XLII. Decontamination factors for some elements.

Element	Prelim. Sep'n.	Decontamination Factors	
		Precipit. Procedure	Total
Pb	-	$>10^8$	$>10^8$
Bi	$2 \times 10^2$	$5 \times 10^5$	$10^8$
Po	$5 \times 10^3$	$2 \times 10^2$	$10^6$
Tl	$2 \times 10^2$	$2 \times 10^2$	$4 \times 10^4$

## PROCEDURE 4

Determination of Mercury in Wheat and Tobacco Leaf by Neutron Activation Analysis Using Mercury-197 and a Simple Exchange Separation

Source: C. K. Kim and J. Silverman, *Anal. Chem.* 37, 1616 (1965).

Apparatus

Samples were counted using a RIDL 200 channel analyzer equipped with a 2 x 2 inch NaI (Tl) well type detector (1 x 1-1/2-inch well size). The reflux condenser used was a Friedrichs Drip Tip type T<sub>5</sub> 24/40; total length, 350 mm. A standard solution of mercury was prepared by dissolving a known weight of mercuric oxide in reagent grade concentrated nitric acid and diluting with demineralized water to give 48.2  $\mu\text{g}$  per ml of mercury in a final concentration of 0.1M nitric acid.

The tobacco leaves were dried in an oven at 45 °C for two weeks prior to analysis.

Sample Irradiation

A weighed sample was transferred to a polyethylene vial. Mercury evaporation was minimized by coating the vials with paraffin, and the temperature of the reactor at the loading site was maintained at less than 30 °C. The vials were positioned side by side within a polyethylene bottle along with a vial containing the standard mercuric nitrate solution and irradiated in the



University of Maryland reactor. The peak thermal neutron flux at the sample position was  $1.4 \times 10^{11}$  neutrons  $\text{cm}^{-2} \text{sec}^{-1}$ .

### Procedure

The irradiated sample was transferred to a 50 ml round bottomed distilling flask containing 3 ml of concentrated nitric acid. About 50  $\mu\text{g}$  of mercury carrier were added and the flask was connected to a reflux condenser. The sample was refluxed for 20 minutes using a Glas-Col heater. A 1 to 1.5 ml portion of concentrated sulfuric acid was added through the side arm of the condenser, and heating was continued for an additional 25 minutes. The flask was cooled with an ice bath, and disconnected from the condenser. The outside of the flask was warmed to about  $80^\circ\text{C}$  to eliminate nitrogen dioxide and was then replaced in the ice bath.

The solution was diluted with 2 ml of water and about 5 ml of concentrated ammonium hydroxide were added dropwise until a solution with a pH of 1 to 2 was obtained. The solution was transferred to a 30 ml Boston bottle and 0.5 gram of ammonium bromide was added; the bottle was shaken to dissolve the salt. A 0.050 ml portion of triple-distilled mercury was added with a microliter pipet; the bottle was capped and shaken for 5 minutes. The mercury droplet was separated from the solution by passing the mixture through a fritted glass disc. The mercury was washed with water and acetone, and the droplet was transferred to a Lusteroid centrifuge tube (1 x 3.5 inches) for counting purposes. The mercury droplet was dissolved by adding 6 to 7 drops of concentrated nitric acid; volume was made to 10 ml with water and counted in the spectrometer. The 68 to 77-keV photo peak region was measured to determine the mercury content.

### PROCEDURE 5

Determination of Mercury in Human Blood by Activation Analysis

Source: Comar et al., Bull. Soc. Chim. France 1962, 56

### Preparation and Irradiation of Samples

In the preparation of samples, extreme care must be exercised to avoid contamination by mercury vapors which often occur in laboratory air. Everything which comes in contact with the blood to be analyzed should be washed in detergent solution, rinsed first with dilute nitric acid, then with bidistilled water, and finally dried.

The blood is withdrawn and placed in a centrifuge tube which contains a drop of heparin. A fraction (0.3 - 1.0 ml) of this blood sample is transferred to a quartz ampoule of about 8 mm o.d. and about 40 mm long. The open end of this ampoule had been drawn out before filling in order to avoid decomposition of the sample during sealing. The weight difference of the quartz sample tubes before and after filling represents the weight of blood to be irradiated.

Standards are prepared by dissolving sufficient  $\text{HgCl}_2$  in bidistilled water to give a final mercury concentration of 0.1  $\mu\text{g/ml}$ . About 0.5 ml of this solution are used as standard and are also sealed in quartz tubes. The sample and standard tubes are packed in groups of five inside a cylindrical aluminum tube after wrapping each ampoule in quartz wool to avoid breakage during handling. The aluminum tubes are sealed and irradiated for seven days at a thermal flux of  $1.6 \times 10^{13}$  neutrons/cm<sup>2</sup> sec.

After irradiation, the samples are allowed to cool for 8-15 days, after which time the residual radioactivity has practically decayed.

### Extraction of Mercury from Samples

Before opening, the quartz ampoules are washed with nitric acid and rinsed with distilled water to be certain that all traces of mercury which may have contaminated the outside of the quartz container before irradiation, has been removed. Before the sample tubes are opened, it is recommended to immerse them in liquid nitrogen to liquify all gaseous decomposition products formed during irradiation. The samples and the fragments from the quartz ampoule are placed in a 50-ml flask and 200.0 mg Hg as  $\text{HgCl}_2$  is added as

carrier. After addition of 2 ml concentrated sulfuric acid, the excess water is distilled and collected in a bubbler containing some powdered  $\text{KMnO}_4$  to retain any volatilized mercury. The final decomposition of the organic matter is accomplished by adding 4 ml of 30 percent  $\text{H}_2\text{O}_2$  and boiling under reflux for 5-10 minutes. After cooling, the decomposition is completed by adding 2 ml of fuming nitric acid and boiling until the solution is clear.

The distillate obtained at the beginning of the decomposition procedure is added to the solution resulting from the oxidation; the  $\text{KMnO}_4$  is reduced by addition of 4 ml of a saturated hydroxylamine sulfate solution. The clear liquid now is filtered through a bed of quartz wool to remove quartz splinters from the sample ampoule. The mercury, already reduced by the hydroxylamine, is precipitated with concentrated ammonia. After decantation, the precipitate agglomerates into a small sphere which is washed first with dilute hydrochloric acid, then dried with acetone.

The radiochemical purity of this mercury sphere is not sufficiently high for precision activity measurements. In fact, it is very possible that during the precipitation of mercury, traces of gold and silver will form an amalgam. In a final purification step, the mercury is distilled in a vacuum of about  $10^{-2}$  mm and the bright droplet of mercury is placed in a small weighing bottle. The weight of the mercury sphere is compared with the 200.0 mg of mercury added as carrier, and a chemical yield is computed. The mercury standards are taken through the same procedure as the samples.

### Counting

In order to insure reproducible counting geometry for samples and standards, the mercury drop is placed in a weighing bottle and is dissolved in 0.5 ml concentrated nitric acid. The weighing bottle (~2 cm o.d.) is placed directly on top of the aluminum can of a scintillation detector. The counting geometry is very close to  $2\pi$  under these conditions and the counting efficiency for both the 68 keV X-ray of  $\text{Hg}^{197}$  and the 279 keV gamma ray of  $\text{Hg}^{203}$  are close to 15 percent.

The gamma counter is mounted in a lead shield of 10 cm wall thickness and is connected to a 100 channel analyzer. The samples are counted for about 1000 minutes. Mercury concentrations are determined in the usual manner by comparing sample and standard count rates. The number of pulses registered by the detector can be determined in two ways:

a. By measurement of the area under the 68 keV or 279 keV photopeaks depending whether the counting is done early or late after the end of the irradiation. The mercury determination based on the area under the Hg<sup>197</sup> photopeak is about 30 times as sensitive than that based on the area under the Hg<sup>203</sup> photopeak, provided the sample counting is done not later than 15 days after irradiation.

The Compton contribution to the photopeak is determined by extrapolating that portion of the spectrum which corresponds to energies higher than the photopeak by a horizontal line. The area under the photopeak then is measured either graphically by summing the pulses accumulated in each channel under the peak and subtracting the Compton contribution.

In a sample containing  $1 \times 10^{-3}$   $\mu\text{g}$  of mercury, the relative standard deviation in the measurement of the Hg<sup>203</sup> activity is 0.85 percent under above irradiation conditions. However, by decreasing the statistical requirements it is possible to measure mercury concentrations of the order of  $2 \times 10^{-4}$   $\mu\text{g}$ , which appears to be the limit of this method.

b. By measurement of the amplitude of the photopeak. In order to carry out a precise measurement, the stability of the associated electronics must be extremely high. By this method, only the number of counts accumulated in the central channel under the peak, corresponding to an energy band of 3 keV, is utilized. Although this method is very fast, it should be used with great caution.

#### PROCEDURE 6.

Determination of Mercury Diffusion in Quartz

Source: G. Leliaert, Pure and Appl. Chem. 1, 121 (1960).

### Irradiation and Separation

Two quartz samples and a mercury standard are irradiated simultaneously for 7 days at a neutron flux of  $5 \times 10^{11}$  neutrons  $\text{cm}^{-2} \text{sec}^{-1}$ .

The quartz tubes with unknown mercury content are coated on the outside with paraffin, so that only the inside can be dissolved away.

The samples are successively weighed, treated with 38 percent hydrofluoric acid containing one drop of concentrated nitric acid and washed twice with distilled water. This series of operations is repeated several times.

The hydrofluoric acid and washing solutions are combined in polythene centrifuge tubes. To each of these mercury-containing solutions 2 ml of mercuric nitrate solution (0.9 mg Hg/ml) is added as a mercury carrier. The solutions are mixed homogeneously and further acidified with nitric acid ( $d = 1.40$ ) in order to minimize co-precipitation of copper, antimony and arsenic sulfides.

The mercury is precipitated as sulfide, the supernatant solution is decanted after centrifugation. The mercuric sulfide residue is washed twice with a dilute solution of hydrofluoric (1N) and nitric (0.1N) acids and once with distilled water. Filtration is finally done on Schleicher and Schüll No. 589 filter paper or on porcelain filtering discs. The standard is treated in the same way.

### Activity Measurements

The low gamma and beta energy of the mercury isotopes formed permit easy purity control. Measurements have been done by means of the multi-channel RCL 256 gamma-ray spectrometer. As a result only  $\text{Sb}^{122}$  seemed to be a source of interference, particularly when measuring gamma radiation above 200 keV. The disintegration ratio of  $\text{Sb}^{122}$  and  $\text{Hg}^{203}$  has been derived from the surface ratio of the respective photo peaks and amounts to 19 percent in the worst cases--two days after the end of irradiation.

From this statement it seems that further purification of the isolated mercuric sulfide is necessary. However, in gamma-ray measurements between the limits of 60 and 85 keV interference by  $\text{Sb}^{122}$  is negligible. Under these measuring conditions no further purification is needed.

#### PROCEDURE 7.

Determination of Mercury in  $\text{LiOH}$  and  $\text{Li}_2\text{CO}_3$  by Activation Analysis

Source: W. N. Crofford and T. A. Kovacina, TID-7606 (1960). p. 248.

#### Introduction

Interest in gas purification utilizing  $\text{LiOH}$  as a  $\text{CO}_2$  absorbent prompted the use of the neutron activation method as a highly sensitive analytical approach to the problem of determining the amount and fate of trace quantities of mercury believed to be present in lithium compounds either naturally or artificially. Favorable cross sections for the reactions  $\text{Hg}^{196} (n, \gamma) \text{Hg}^{197}$  and  $\text{Hg}^{202} (n, \gamma) \text{Hg}^{203}$  insured the high sensitivity of about 0.1  $\mu\text{g}$  Hg required.

The comparator method was used; that is, a sample of  $\text{LiOH}$  and  $\text{Li}_2\text{CO}_3$  containing unknown traces of Hg along with comparators containing known amounts of Hg were irradiated in the Naval Research Laboratory's Swimming Pool Reactor (NRR). After radiochemical separation and purification, the gamma activities of the known and unknown weights of Hg were compared.

#### Irradiation

Samples of  $\text{LiOH}$  and  $\text{Li}_2\text{CO}_3$  to be irradiated, ranging from 300 to 400 mg in weight, were sealed in size number 1 gelatin capsules and individually wrapped in 1/4-mil Mylar film. Two comparators of 50 and 100  $\mu\text{g}$  of Hg, as  $\text{Hg}(\text{NO}_3)_2$  in water, were aliquoted onto a Mylar film and dried under a heat lamp. The comparators were also sealed in gelatin capsules and wrapped in Mylar. The Mylar wrapping was necessary as the gelatin becomes very brittle after eight hours or more of irradiation in the reactor.

The above samples were irradiated in the NRR for eight hours at a flux of  $10^{12}$  n/cm<sup>2</sup>/sec for a total nvt of  $2.9 \times 10^4$ .

### Radiochemical Separations

The radiochemical purification of the radioactive Hg was a modification of the periodate precipitation method.<sup>205</sup> The samples of LiOH and Li<sub>2</sub>CO<sub>3</sub>, along with the comparators, were dissolved in water and neutralized dropwise with concentrated HNO<sub>3</sub>. An excess of 1-1/2 ml of concentrated nitric acid was added and the solution was diluted to 150 ml with water. Hold-backs of Cu(NO<sub>3</sub>)<sub>2</sub>, NaNO<sub>3</sub>, H<sub>3</sub>PO<sub>4</sub>, and H<sub>2</sub>SO<sub>4</sub> were added and the solution was heated to the boiling point to facilitate exchange. Two grams of potassium periodate dissolved in 50 ml of water were slowly added to the boiling solution and the precipitate of Hg<sub>5</sub>(IO<sub>6</sub>)<sub>2</sub> was allowed to digest for 1/2 to 1 hours, after which time it was filtered through a medium, sintered-glass crucible and washed with warm water. The precipitate was dissolved off the filter with hot, concentrated HNO<sub>3</sub>, diluted with 0.1N HNO<sub>3</sub>, and the above radiochemical purification procedure was twice repeated. After the final precipitation and wash with hot water, the Hg<sub>5</sub>(IO<sub>6</sub>)<sub>2</sub> precipitate was dried for an hour at 100 °C. The Hg<sub>5</sub>(IO<sub>6</sub>)<sub>2</sub> was weighed in a gelatin capsule and counted gamma wise. A yield of between 40 and 70% was obtained.

Counting was begun on the purified samples 17 hours after removal from the reactor. A well-type scintillation counter with a 2 x 2 inch NaI (Tl) crystal was used for gamma counting as well as for determining the  $\gamma$ -spectrum with a single channel analyzer. Purity of the radioactive Hg was verified by the  $\gamma$ -spectrum and analysis of the  $\gamma$ -decay curves.

An analysis of the decay curves and the spectra, even 17 hours after removal from the reactor, did not show that any 24-hour Hg<sup>197</sup> was present. The 65-hour isotope was abundant for about seven days, after which time 48-day Hg<sup>203</sup> began to appear.

## PROCEDURE 8.

## Separation of Radioactive Mercury Isotopes From Gold Targets

Source: G. Friedlander and C. S. Wu, Phys. Rev. 63, 228

The neutron-bombarded gold targets were dissolved in aqua regia, a few milligrams each of mercuric chloride and platinum chloride were added, and the solution was evaporated to about 0.5 cc. The residue was taken up in water, and gold and mercury were then extracted with ethyl acetate by the procedure of Noyes and Bray.<sup>17</sup> The separation of gold and mercury was then carried out according to Noyes and Bray. The mercury was finally precipitated in the form of the compound  $\text{HgO}\cdot\text{HgINH}_2$ .

The pertinent steps of the Noyes-Bray procedure are presented in Appendix I.

## APPENDIX I.

## ANALYSIS OF THE GOLD GROUP

Solution of Hg, Au, Ir<sup>1</sup>, Pd, and Rh<sup>1</sup> as chlorides.

## 1. Shake with ethyl acetate

Ester layer: $\text{HgCl}_2$ , $\text{AuCl}_3$		Water layer: $\text{H}_2\text{PtCl}_6$ , $\text{H}_2\text{IrCl}_6$ , $\text{H}_2\text{PdCl}_4$ , $\text{H}_3\text{RhCl}_6$
2. Shake with 3 N $\text{NH}_4\text{Cl}$		
Ester layer $\text{AuCl}_3$	Water layer: $(\text{NH}_4)_2\text{HgCl}_4$	
3. Evaporate, ignite, dissolve in $\text{HCl-HNO}_3$ , add NaOH and KI.	4. Add NaOH and KI	
Red or purple precipitate: Au	Orange precipitate: $\text{HgO}\cdot\text{HgINH}_2$	

<sup>1</sup> Some or all of the element may be found here when it is associated with certain other elements.

Separation of Mercury from Gold

A slightly acidic (<2 N  $\text{HCl}$ ) solution of Hg, Au, and the platinum metals is extracted twice with an equal volume of ethyl acetate. The



organic extracts, containing gold and mercury, are not combined but are shaken with an equal volume of 3 N  $\text{NH}_4\text{Cl}$  successively (the one more dilute in mercury first), since thereby, in accordance with the distribution law, the mercury passes into the aqueous layer more completely. In this step the mercury is removed almost completely (98-99 percent) owing to the formation of the  $\text{HgCl}_4^{--}$  anionic complex; not more than 2 percent of the gold is removed in step 2 from the ethyl acetate.

The combined  $\text{NH}_4\text{Cl}$  solutions from step 2 are washed with 10 ml of fresh ethyl acetate, to which 3 drops of 6 N  $\text{HCl}$  had been added. The aqueous solution now contains mercury only and is ready for specific testing with  $\text{NaOH}$  and  $\text{KI}$ .

$\text{NH}_4\text{Cl}$  is used rather than  $\text{HCl}$  in the extraction for the reasons that the aqueous solution is then ready for the precipitation of mercury in Step 4 and that ethyl acetate is much less soluble in a solution of  $\text{NH}_4\text{Cl}$  than in  $\text{HCl}$ .

#### PROCEDURE 9.

Separation of Neutron Deficient Mercury and Gold Isotopes from Bismuth Targets by Solvent Extraction

Source: E. T. Hunter and J. M. Miller, *Phys. Rev.* 115, 1053 (1959).

The target material is dissolved in concentrated nitric acid. Mercury and gold are extracted together into ethyl acetate from the original nitric acid solution, to which is added a trace of chloride. Mercury is removed from the organic layer with 3M  $\text{HCl}$ , precipitated as  $\text{HgS}$ , and counted. The remainder of the organic layer is evaporated, the gold is taken up with aqua regia, then carefully reduced with hydrazine hydrate and counted as the metal.

#### PROCEDURE 10.

Radiochemical Mercury Separation from Gold Targets

Source: W. W. Meinke, *Chemical Procedures Used in Bombardment Work at Berkeley*, AECD-2738, p. 231, (1949).

Element separated: Mercury	Procedure by: R. W. Fink
Target material: Gold	Time for Sep'n: 70 min.
Type of bbd: 60 MeV protons	Equipment required: Standard
Yield: Near 80-90 percent	
Degree of purification: Excellent - factor of 100 from activities present.	

**Procedure:**

1. The gold target is dissolved by heating in 4 milliliters hot, concentrated aqua regia. Pt and Hg carrier (50  $\mu$ g) are added. Five or more extractions with isoamylacetate using 3 milliliters each portion are made. The gold will be found in the organic layer.
2. The aqueous layer is boiled to near dryness with concentrated HCl to expel  $\text{HNO}_3$ , and excess  $\text{SnCl}_2$  added to precipitate.  $\text{Hg}_2\text{Cl}_2$ , which is then washed until free from red  $\text{Pt}^{++}$  color.
3. The  $\text{Hg}_2\text{Cl}_2$  precipitate is then redissolved in 2 milliliters of dilute aqua regia, and used as the mercury fraction.

**Remarks:**

- a. The isoamyl acetate extraction of gold from mercury is quantitative in presence of 0.1N or more chloride. This is the method used to milk gold daughters from the mercury fraction.

PROCEDURE 11.

**Radiochemical Mercury Separation from Platinum Targets**

Source: W. W. Meinke, Chemical Procedures Used in Bombardment Work at Berkeley, AECD-2738, p. 230, (1949).

Element separated: Mercury	Procedure by: R. W. Fink and
Target material: Platinum	D. G. Karraker
Type of bbd: 65 MeV $\alpha$ -particles	Time for sep'n: 60 minutes
for 3 hours	Equipment required: Standard

Yield: ~70 percent

Degree of purification: Excellent - factor of at least 100 from activities present.

Procedure:

1. Pt target dissolved in 4 milliliters of aqua regia in a porcelain crucible. 50  $\mu\text{g}$  Au and Hg carriers added. The solution is evaporated to expel  $\text{HNO}_3$ .
2. Extracted 5 times with 1/5 volume of isoamyl acetate in presence of at least 0.1N  $\text{HCl}$ . The isoamyl acetate layer contains gold free from mercury.
3. The aqueous layer has excess  $\text{SnCl}_2$  added to ppt  $\text{Hg}_2\text{Cl}_2$ . The Pt is reduced to a beautiful red  $\text{Pt}^{++}$  color. The precipitate is washed until free of this color.
4. The precipitate is dissolved in dilute aqua regia and used as the mercury fraction.

Remarks:

- a. Recycling will improve purity, although this method has been shown to give excellent radiochemical purity.

PROCEDURE 12.

Radiochemical Separation of Mercury

Source: W. W. Meinke, Chemical Procedures Used in Bombardment Work at Berkeley, AECD-2738, p. 233, (1949).

Element separated: Mercury

Procedure by: Prohaska

Target material: Au

Time for sep'n: Two or more days

Type of bbd: Neutron capture  
in pile

Equipment required: Separatory funnels,  
+ ordinary beakers, flask, etc.

Yield: ? probably 60-80 percent

Degree of purification: 95-98 percent

Advantages: Will separate 5-10 mg of Hg from 100 g of Au.

## Procedure:

1. Dissolve sample (assume 100 gms of Au) in 250 ml hot conc. HCl and minimum  $\text{HNO}_3$  under (air cooled) reflux condenser.
2. When sample completely dissolved, dilute to 500 ml (approx.  $6 \text{ M H}^+$ ). Extract with four successive 200 ml portions of ether.
3. Add NaOH to  $\text{H}_2\text{O}$  portion until  $\text{pH} \approx 1$ . Add  $\text{H}_2\text{S}$  and precipitate  $\text{Au}_2\text{S}_3 + \text{HgS}$ . Centrifuge.
4. Dissolve  $\text{HgS} + \text{Au}_2\text{S}_3$  in (minimum) 6N HCl + drops of concentrated  $\text{HNO}_3$ , volume of solution should be less than 100 ml at this point.
5. Extract with successive 50 ml portions of ether until no yellow color of  $\text{AuCl}_4^-$  can be observed in  $\text{H}_2\text{O}$  portion.
6. Extract with 2 additional 50 ml portions of ether.
7. Again reduce pH to  $\approx 1$  with NaOH and ppt  $\text{HgS}$  with  $\text{H}_2\text{S}$ .
8. Repeat the solution and extraction procedure.

## Remarks:

In the three ether extractions, an estimated 20-30 percent of the  $\text{HgCl}_2$  would be extracted along with  $\text{AuCl}_3$ . Working up these extracts for Hg would probably increase total yield of Hg separated.

It appears doubtful that purity of Hg reported would be increased by further solution and extraction.

## PROCEDURE 13.

Preparation of  $\text{Hg}^{197\text{m}_2}$  and  $\text{Hg}^{197}$  in High Specific Activity

Source: Case et al., ORNL Radioisotopes Procedures Manual, Oak Ridge National Laboratory Report, ORNL-3633 (1964).

Production method:

Half-life:  $\text{Hg}^{197\text{m}_2}$  24 hour

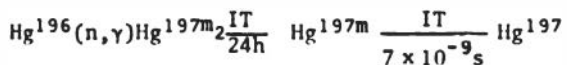

$\text{Hg}^{197}$  65 hour

Cross section:  $\text{Hg}^{197\text{m}_2}$ , 400 barns

Radiations:

$\text{Hg}^{197}$ , 900 barns

Isotope	Beta	Gamma	Other
$\text{Hg}^{197\text{m}_2}$	None	0.133(97%)	EC (3%)
		0.164(97%)	IT (97%)
		0.191(3%)	
		0.275(3%)	

Target: HgO

Target weight: 1 g

Neutron flux:  $1 \times 10^{13}$  neutrons

$\text{cm}^{-2} \text{sec}^{-1}$

Irradiation time: 3 days	Hg <sup>197</sup>	None	0.077	EC
Reactor yield: 1.6 curies			0.191	
Processing yield: 80%				Processing facility and shielding required: manipulator cell, 3 in. lead equivalent
Radiochemical purity: 98% (exclusive of Au <sup>197m</sup> daughter, Hg <sup>203</sup> , and Hg <sup>197m2</sup> )				

1. Prepare equipment
  - Hot off-gas scrubber unit (Figure 46)
  - 150 ml Pyrex beaker
  - 100 ml product bottle
2. Open irradiation can and transfer target material into beaker under hot off-gas scrubber assembly.
3. Add a minimum amount of 16M HNO<sub>3</sub> and heat the solution until target is dissolved.
  - Overheating may result in a loss of mercury.
4. Adjust volume to 50 ml with distilled H<sub>2</sub>O and transfer to product bottle.
  - Product solution should be clear and water-white.
  - Nitric acid concentration should be >1M since hydrolysis might occur at lower values.
5. Sample and analyze for:
  - Molarity of HNO<sub>3</sub>
  - Total solids
  - Hg<sup>197</sup> concentration
  - Radiochemical purity
  - Refer to ORNL Master Analytical Manual (TID-7015) procedure nos. 9 0732005, 9 0731000, 9 0732009, 9 0733000, 9 073301, and 9 073302.

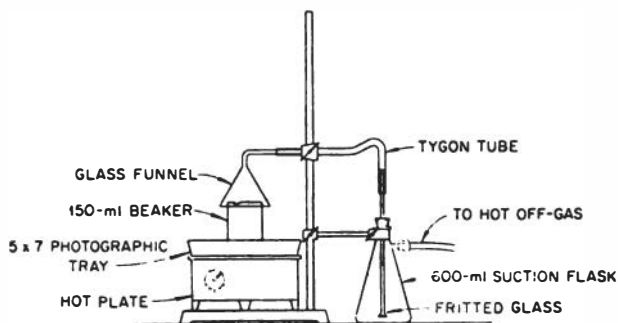

Figure 46. Hot Off-Gas Scrubber Unit.

## PROCEDURE 14.

Preparation of  $\text{Hg}^{203}$  in High Specific Activity

Source: Case et al., ORNL Radioisotopes Procedures Manual, Oak Ridge National Laboratory Report ORNL-3633 (1964).

Production method: $\text{Hg}^{202}(\text{n},\gamma)\text{Hg}$	Half-life: 45.4 days
Cross section: 3.0 barns	Radiations:
Target: $\text{HgO}$	Beta                      Gamma
Target weight: 10 g	0.208                      0.279
Neutron flux: $2 \times 10^{14}$ neutrons $\text{cm}^{-2} \text{sec}^{-1}$	Processing facility and shielding required: manipulator cell, 3 in. lead equivalent
Irradiation time: 5 months	
Reactor yield: 100 curies	
Processing yield: 80 percent	
Radiochemical purity: 98 percent	

1. Prepare equipment
  - Hot off-gas scrubber unit (Figure 46)
  - 100 ml product bottle
  - Three 150 ml Pyrex beakers
2. Open irradiation can and transfer target material into beaker under a hot off-gas scrubber assembly.
3. Add the minimum amount of 16M  $\text{HNO}_3$  necessary to dissolve the target.
  - Low heat will increase rate of dissolution.
4. Adjust volume to 50 ml of 5 to 6M  $\text{HNO}_3$  necessary to dissolve product bottle.
  - Solution should be clear and water-white.
5. Remove  $\text{Tl}^{204}$  contaminant if present.
  - a. Evaporate  $\text{Hg}^{203}$  solution to near dryness under hot off-gas scrubber assembly.
    - Concentration of  $\text{Tl}^{204}$  is determined by radiochemical analysis. This removes  $\text{HNO}_3$ . Overheating may result in loss of mercury.
  - b. Adjust volume to 100 ml of distilled  $\text{H}_2\text{O}$ .
    - Low heat will facilitate dissolution of  $\text{Hg}(\text{NO}_3)_2$ .
  - c. Add hydrazine hydrate dropwise until pH of  $\sim 10$  is attained.
    - Avoid violent reaction between  $\text{HNO}_3$  and hydrazine by stirring constantly and adding hydrazine very slowly. This step reduces mercury to the element.
  - d. Allow  $\sim 1$  hour for finely divided elemental mercury to deposit on bottom of beaker.

- |  |  |
|--|--|
| <p>e. Decant solution from elemental mercury and wash twice with 50 ml portions of distilled H<sub>2</sub>O.</p>                             | <p>Allow sufficient time for finely divided mercury to deposit on bottom of beaker after each H<sub>2</sub>O wash.</p> |
| <p>f. Evaporate until mercury forms a single drop, but do not allow beaker to become dry.</p>  | <p>Overheating will result in loss of mercury.</p>   |
| <p>g. Transfer elemental mercury to a clean beaker and dissolve in 50 ml of 5 to 6M HNO<sub>3</sub> under hot off-gas scrubber assembly.</p> |  |
| <p>h. Adjust acidity of HNO<sub>3</sub> to &gt;1M. Transfer product solution to product bottle.</p>  | <p>Product solution should be clear and water-white.</p>   |
6. Resample for determining Tl<sup>204</sup> concentration.
7. Sample and analyze for  
Molarity of HNO<sub>3</sub>  
Total solids  
Hg<sup>203</sup> concentration  
Radiochemical purity
- Refer to ORNL Master Analytical Manual (TID-7015), procedure no. 9 0733491.

PROCEDURE 15.

Ion Exchange Separation of Zinc, Cadmium, and Mercury in Aqueous and Partial Non-Aqueous Media

Source: E. W. Berg and J. T. Troemper, Anal. Chem. 30, 1827 (1958).

Zinc, cadmium and mercury can be separated as their anionic chloro complexes by ion exchange both in aqueous and in partial non-aqueous media. Dowex-1 resin is treated in a batch process with 0.5 M hydrochloric acid to convert it to the chloride form and transferred as a slurry to a glass column of about 1.2 cm inside diameter. The resin bed is then washed with more 0.5 M hydrochloric acid to ensure complete conversion to the chloride form, and to remove any iron impurity present in the commercial product. It is necessary to use a dilute solution of hydrochloric acid, because solutions of approximately ≥2 M produce an anionic chloro complex of iron which is absorbed by the resin. After treatment with the acid, the column is washed with water and then with 150 to 200 ml of the sample solvent.

A mixture of the metal ions prepared from standard solutions is adjusted to 50 ml with the appropriate solvent, and added to the column. The eluant can be either 0.01 M HCl, 0.01 M HCl + 10 percent by volume methanol mixture, or 0.01 M HCl + 25 percent by volume methanol mixture. The corresponding resin bed lengths are 28 inches, 18 inches and 6 inches. An additional 10 ml of the solvent is used to complete the transfer of the sample to the resin bed. The total sample volume is 60 ml. The sample is then eluted from the column with the appropriate solvent at a flow rate of 1.5 to 2.0 ml per minute.

The solution containing  $Zn^{++}$ ,  $Cd^{++}$ , and  $Hg^{++}$  is buffered with an ammonium chloride-ammonium hydroxide buffer to a pH slightly over 10 and titrated with a standard solution of versene. A chelating dye, Eriochrome Black T, is used as end-point indicator.

Mercury is determined by precipitating and weighing  $HgS$ . This method was chosen because mercury is eluted with 0.1 M thiourea - 0.01 M hydrochloric acid mixture from which  $HgS$  can conveniently be precipitated. The solution is heated to about 90 °C for 30 minutes to form sulfide ions by hydrolysis of thiourea. After addition of an excess of concentrated ammonium hydroxide precipitation occurs. The  $HgS$  forms large aggregates and is easily filtered. The addition of dilute ammonium hydroxide results in a colloidal precipitate which is difficult to filter.

The ion exchanger can be readied for reuse in one step by washing the resin bed free of thiourea with the eluting agent for zinc and cadmium.

#### PROCEDURE 16.

Separation of Tin, Mercury, Zinc, and Silver in NaK Alloy by Ion Exchange

Source: A. A. Smales, Proceedings of the International Conference on the Peaceful Uses of Atomic Energy, Vol. 9, p. 273 (1955).

One gram of alloy is dissolved in 35 ml methanol. Water is added and the solution titrated with standard acid to find accurately the amount of



alloy taken. The calculated quantity of concentrated hydrochloric acid, 10 mg each of  $\text{Sn}^{++}$ ,  $\text{Hg}^{++}$ , and  $\text{Zn}^{++}$  as chlorides, and, with stirring, 10 mg Ag as nitrate are added and the solution is transferred to a 250 ml flask and made up to the mark with water. The clear solution should be exactly 2 M in hydrochloric acid.

25 ml are pipetted onto a 150 mm x 7 mm diameter column of 70-100 mesh Amberlite IRA-400 which has been washed with 2 M HCl and is allowed to feed under its own head. The column is then eluted with 37 ml 2 M HCl, 85 ml 2 M  $\text{HNO}_3$  and 17 ml 7.5 M  $\text{NH}_4\text{OH}$  successively at an average flow rate of 0.44 ml/minute. The HCl fraction is collected for feeding to the second column, the first 25 ml of the  $\text{HNO}_3$  fraction contains the tin and zinc and the remainder (60 ml) contains the mercury. The  $\text{NH}_4\text{OH}$  fraction contains the silver.

#### PROCEDURE 17.

Polonium, Thallium, and Mercury Ion Exchange Separation from Neutron Irradiated Meteorites

Source: W. D. Ehmann and J. R. Huizenga, *Geochim. and Cosmochim. Acta* 17, 125 (1959).

#### Solution and General Ion Exchange Separation

The irradiated meteorite powder is transferred to a small platinum disc containing 5 ml of concentrated  $\text{H}_2\text{SO}_4$ , a  $\text{Po}^{208}$  spike, and mercury and thallium carriers. The slurry is warmed under a heat lamp with occasional stirring for about 15 to 20 minutes. Concentrated HF is then added dropwise with stirring until effervescence ceases. Finally, an additional 10 ml of HF is added and the mixture is gently heated under a heat lamp at a distance of at least 20 inches until the residue is reduced to a paste. Care must be taken to prevent the mixture from going to dryness at any time. Additional HF is added, and the evaporation repeated.

Concentrated  $\text{HNO}_3$  (5 ml) is added to the resulting paste, and the slurry is transferred to a glass beaker. A small amount of concentrated

HCl is added, and after any evidence for reaction ceases, the solution is made up to 50 ml with 9 M HCl. Usually the solution at this point is clear. In some cases, however, a very small black deposit settles out on standing. Where this is observed, the residue should be treated with aqua regia, diluted to 9 M HCl and again added to the main portion.

The solution then is placed on an anion exchange column containing Dowex-1, X-10, 100-200 mesh. The resin bed is about 1/2 inch in diameter and 5 inches long. After introduction of the sample, the column is washed successively with 75 ml of 9 M HCl, 75 ml of 0.5 M HCl, and 25 ml of distilled H<sub>2</sub>O. This treatment elutes the gross amount of activity from the column, which may now be treated in a 'low-level' laboratory (column was <<5 mr/hr at 2 inches).

The polonium is eluted from the column with 75 ml of 1 M H<sub>2</sub>SO<sub>4</sub>, thallium is removed from the column with 75 ml of 1 M H<sub>2</sub>SO<sub>4</sub> freshly saturated with SO<sub>2</sub>.

### Mercury Chemistry

Mercury is eluted from the column with 75 ml of 4 M HNO<sub>3</sub>. The eluant is neutralized to pH 6.5 with solid NaOH and HgS precipitated by addition of H<sub>2</sub>S gas. The HgS is separated by centrifugation, washed with H<sub>2</sub>O and dissolved in a few drops of aqua regia. Iridium carrier is added, and the solution evaporated with low heat to near dryness to remove excess HNO<sub>3</sub> after addition of 5 ml of concentrated HCl.

The small volume of solution is diluted to 10 ml with H<sub>2</sub>O, and mercury is precipitated by the addition of several drops of freshly prepared SnCl<sub>2</sub> solution. The mercury precipitate is separated by centrifugation, washed with H<sub>2</sub>O, dissolved in aqua regia, and again precipitated as above using iridium carrier and SnCl<sub>2</sub>.

The final mercury precipitate is again separated and washed and dissolved in several drops of aqua regia. The resulting solution is diluted to 10 ml with H<sub>2</sub>O, brought to pH 7 with NaOH, and HgS precipitated with H<sub>2</sub>S gas.

The HgS is filtered on weighed paper, washed with H<sub>2</sub>O and ethyl alcohol, dried at 110 °C, weighed and mounted for counting. Chemical yields generally range from 50 to 80 percent.

#### PROCEDURE 18.

##### The Abundance of Mercury in Meteorites and Rocks by Neutron Activation Analysis

Source: W. D. Ehmann and J. F. Lovering, *Geochim. et Cosmochim. Acta* 31, 357 (1967).

##### Sample Preparation

Mercury is a common contaminant in chemical laboratories. This, compounded by its high vapor pressure at room temperature, makes the pre-irradiation history and treatment of the sample to be analyzed of critical importance. In the case of many meteorites analyzed in this work, the specimens were originally in museum collections and the details of the conditions of storage over the years are not available. Carbonaceous chondrites, in particular, could act as scavengers for mercury, due to their content of free sulphur.

Certainly specimens stored or powdered in the environment of a typical chemical laboratory, or displayed in cases containing assorted terrestrial minerals, may have picked up mercury contamination. In the case of the more friable specimens this contamination may have penetrated into the interior of even rather large specimens.

While the extent of this problem is fully recognized, it is still felt that useful data on mercury abundances can be obtained by analyzing sufficient samples from the various classes of materials and using all possible care in the preparation of the sample once it is in the investigator's hands. In virtually all cases the specimen to be analyzed was first fractured in a steel mortar and interior fragments selected. These fragments were finely powdered in an agate mortar in an office area away from chemical laboratory

operations. The powdered samples were stored in clean sealed vials or bottles prior to weighing into quartz irradiation vials.

The powdered specimens of 0.1-0.5 g were introduced into weighed quartz vials which had been boiled in aqua regia, rinsed in distilled water and acetone, and dried at 110 °C. Prior to this work there was no history of mercury or mercury salts being used in the areas of sample preparation. The vials were then oven dried for several hours at 65 °C prior to sealing. Weight losses were generally less than 1 percent. The quartz vials were quickly sealed with a hydrogen torch. Initially, during the sealing operation, the end of the vial containing the sample was cooled with water. With experience, the sealing operation became so rapid that water cooling was not required.

#### Flux Monitors and Carriers

Carrier solutions for mercury were in most cases prepared immediately prior to use and in any case not stored for extended periods. These solutions were prepared by dissolving triple distilled mercury in 1:1 nitric acid and diluting with distilled water into volumetric glassware.

Flux monitor solutions were prepared by dilution of a freshly prepared carrier solution. The flux monitor solutions were in all cases used within an hour of their preparation to avoid problems associated with the stability of very dilute solutions. The density of the flux monitor solution was determined and an aliquot introduced into a weighed quartz vial containing approximately 50 mg of Specpure SiO<sub>2</sub> (Johnson-Matthey, London, Cat. No. J.M. 425, Lab. Control No. 23403). The weight of the flux monitor solution added was immediately determined and the amount of mercury added (usually 10-20 µg for meteorite analyses and 5-10 µg for rock analyses) thereby derived. The filled flux monitor vials were oven dried at 65 °C for three days and sealed like the sample vials.

Two flux monitor vials were packaged with five or six sample vials in each irradiation can. The average specific activity of the mercury in the two flux monitors was used for the calculation of the abundance of mercury

in the samples. The very small deviations of the two flux monitor specific activities from their mean (average =  $\pm 2.7$  percent), even where the amounts of mercury varied by more than a factor of two, suggested that self-shielding, contamination, and preparative errors were negligible.

It should be noted that the Specpure  $\text{SiO}_2$  used in the preparation of the flux monitors was also analyzed in duplicate and found to contain less than 0.06 ppm mercury. Hence, the mercury in the 50 mg of  $\text{SiO}_2$  used in the flux monitor vials was negligible compared to the amount added via the flux monitor solution.

### Irradiation

Sample and flux monitor vials were irradiated together in the Australian Atomic Energy Commission HIFAR reactor in a flux of approximately  $6 \times 10^{12}$  n/cm<sup>2</sup>-sec. Irradiation times varied from 5 days to 2 weeks depending on the expected levels of mercury abundance. Chemical separations were generally started 36-48 hours after removal from the reactor and the samples were ready for counting in an additional 2-3 days.

Self-shielding problems were shown to be negligible by the concordant results obtained in meteorite samples varying by nearly a factor of two weight and flux monitors varying more than a factor of two in mercury content.

### Radiochemical Techniques

Consideration of the possible important radiochemical contaminants resulted in addition of hold-back carriers for chromium (27.8 day  $\text{Cr}^{51}$ ), gold (2.7 day  $\text{Au}^{198}$ ), iridium (74 day  $\text{Ir}^{192}$ ), and a scavenging step for silver (253 day  $\text{Ag}^{110}$ ).

While several steps in the procedures contribute to the elimination of these impurities chromium appears to be largely eliminated in the 0.01 M HCl anion exchange elution, iridium in the  $\text{Hg}_2\text{Cl}_2$  precipitation, gold in the ethyl acetate solvent extraction, and silver in the AgCl precipitation. The bulk activity of the irradiated sample is removed in the anion exchange step. In 0.5 M HCl major contaminants such as iron, cobalt, nickel, alkali

metals, and alkaline earths are not held on the column. Many other possible contaminants are also discriminated against in this step.

In the processing of an irradiation unit the sample vials were processed first and then removed from the hot laboratory before the flux monitor vials were opened.

A number of samples were recycled through these chemical procedures after they had been counted. No significant differences were found.

#### Detailed Separation Procedures

In these procedures the vials containing the rock or meteorite samples and the vials containing the mercury flux monitors were processed identically. After the irradiation all vials were washed in hot aqua regia, distilled water, and acetone prior to opening. The opened vials were emptied by gentle tapping over a Teflon evaporating dish, containing a few drops of distilled water. An aliquot of a standard solution of mercuric nitrate containing approximately 50 mg of mercury, as well as hold-back carriers for iridium (as chloride), gold (as chloride), and chromium (as dichromate) were added to the sample in the dish at this point. After the powder had been discharged the interiors of the vials were individually washed in warm aqua regia, using a transfer pipette to thoroughly flush both halves of the broken vial. This wash solution was combined with the bulk of the sample at a later step in these procedures.

The powdered sample in the dish was first treated with 20 ml of concentrated HF plus one or two drops of concentrated  $H_2SO_4$ . The dish was placed approximately seven inches below an infrared heat lamp and heated to reduce the solution volume to approximately 2 ml. The HF addition was then repeated and the volume reduced to 1 ml. To the residue was added 5 ml of aqua regia and the previously mentioned vial wash solution. The solution was then reduced to near dryness under the heat lamp. Loss of mercury occurs if at any point in the dissolution the solution goes to dryness.

The salts in the Teflon dish were then dissolved in 20 ml of 0.5 M HCl. In the case of the chondritic meteorite samples a fine dark residue was often

observed at this point. In these procedures fusion steps or high temperature dissolution had to be avoided to prevent loss of mercury. Therefore, this slight residue was not further processed, but rather removed by centrifugation and discarded.

The 0.5 M HCl solution of the sample was then added to a pre-washed Dowex 1, X-4 50-100 mesh, anion exchange column which was approximately 1/4 inch I.D. and 4 inches in length. Mercury was held on this column while a large number of interfering ions were eluted with 40-50 ml of 0.5 M HCl. The column was further washed with 25 ml of 0.1 M HCl and 25 ml of distilled water which removed additional interferences.

Mercury was eluted from the column with 40-50 ml of freshly prepared 0.1 M thiourea which was also 0.01 M in HCl. The eluent containing the mercury was heated to 80 °C for fifteen minutes to hydrolyze the thiourea and treated with several drops of concentrated NH<sub>4</sub>OH to precipitate the mercury as HgS. The precipitate was separated by centrifugation and washed with warm distilled water.

The precipitate HgS was dissolved in a few drops of warm aqua regia, heated with a few drops of concentrated HCl to remove excess NO<sub>3</sub><sup>-</sup>, diluted to 20 ml with distilled water, and centrifuged to remove free sulfur. The solution was then neutralized with a saturated solution of Na<sub>2</sub>CO<sub>3</sub> to the point where a precipitate of Hg(OH)<sub>2</sub> just persisted, and then made acid with two drops of concentrated HCl. To this slightly acid solution was added 10 ml of a freshly prepared 50 percent by weight solution of phosphorous acid. The solution was then warmed to 60 °C for ten minutes to initiate precipitation and cooled in a water bath at 10 °C for at least one hour. The white precipitate of Hg<sub>2</sub>Cl<sub>2</sub> (further reduction causes the precipitate to darken due to the formation of elemental mercury) was centrifuged and washed twice with 5 ml aliquots of 0.5 M HCl.

The Hg<sub>2</sub>Cl<sub>2</sub> precipitate was dissolved in a few drops of aqua regia and additional gold carrier added. This solution was diluted with 10 ml of 8 M HCl and AuCl<sub>4</sub><sup>-</sup> extracted with two successive 10 ml portions of ethyl

acetate. The aqueous layer which contained the mercury was reduced to a volume of 2 ml on a hot plate to remove excess HCl and diluted with 30 ml of distilled water.

A few drops of  $\text{AgNO}_3$  were added as a silver scavenger. The precipitate of  $\text{AgCl}$  was centrifuged and discarded.

The mercury containing solution was then adjusted to pH 6.5 with a saturated solution of  $\text{Na}_2\text{CO}_3$  and warmed to  $80^\circ\text{C}$ . A small amount of solid thioacetamide (the size of the head of a match) was added to the solution with stirring to precipitate mercury as  $\text{HgS}$ . The precipitate was digested at  $80^\circ\text{C}$  for fifteen minutes, washed several times with distilled water and ethyl alcohol, and transferred to a weighed, rimmed, stainless steel planchet, using absolute ethyl alcohol and a transfer pipette. The precipitate was dried at  $105^\circ\text{C}$  in a drying oven for one hour, prior to final weighing and counting.

Any extended heating of solutions containing both mercury and chloride ion, or evaporation to dryness greatly decreases the chemical yields of these procedures. Using minimal amounts of aqua regia in the various dissolution procedures is advantageous. Chemical yields, using these procedures, varied from as little as 10 percent to as high as 80 percent.

### Counting

The radionuclides of primary analytical interest are  $\text{Hg}^{197\text{m}}$ ,  $\text{Hg}^{197}$ , and  $\text{Hg}^{203}$ . In meteorites, contributions to the  $\text{Hg}^{203}$  by fast neutron reaction products such as  $\text{Tl}^{203}$  ( $n,p$ )  $\text{Hg}^{203}$  and  $\text{Pb}^{206}$  ( $n,\alpha$ )  $\text{Hg}^{203}$  are negligible due to their low reaction cross sections, and the low abundance of thallium and lead in the materials analyzed.

### $\text{Hg}^{197}$

The intense 0.0776 MeV gamma-rays emitted by 65 hour half-life  $\text{Hg}^{197}$  were easily observed in the spectra obtained. However, it was felt that the data obtained from this radionuclide would not be superior to that obtained by counting the longer-lived  $\text{Hg}^{203}$ . First, any slight radiochemical contamination in the counting sample which would emit ionizing radiation would also



generate mercury X-rays ( $K_{\alpha I} = 70.8$  keV). Since this X-ray peak falls close to the photopeak of the  $\text{Hg}^{197}$  gamma-ray, some difficulty would be experienced in this resolution and the interpolation of a proper base-line correction. In addition, variable chemical yields might require corrections for self-absorption and self-scattering in the use of such low energy radiations.

#### $\text{Hg}^{197m}$

There were also several disadvantages in the use of the 0.133 MeV gamma-rays of 24 hour half life  $\text{Hg}^{197m}$  as an analytical radionuclide. The region near 0.133 MeV in the experimental spectra contains an addition peak due to the summation of two 0.0766 MeV gamma-rays from the decay of  $\text{Hg}^{197}$ . In addition there are contributions to this region from the low intensity 0.19 MeV gamma-ray of  $\text{Hg}^{197}$ , and scattered radiation from the principal 0.28 MeV gamma-ray of  $\text{Hg}^{203}$ . Therefore, precise determination of mercury after passage of up to five half lives by means of  $\text{Hg}^{197m}$  may be impossible due to difficulties in baseline interpolation and the relatively low intensity.

#### $\text{Hg}^{203}$

For reasons discussed above,  $\text{Hg}^{203}$  was chosen as the analytically most important radionuclide. All counting was done by gamma scintillation spectrometry. A 1-1/2 x 1 inch NaI(Tl) scintillation crystal with a thin aluminum window coupled through a detector to a RIDL 200 channel analyzer, or a Packard 400 channel analyzer was used. The front face of the crystal was approximately 3/4 inch from the sample planchet during counting.

Counting periods varied from two minutes up to 1000 minutes depending on the level of activity involved. For most meteorite samples the integration of the  $\text{Hg}^{203}$  photopeak above an interpolated baseline yielded more than  $10^4$  counts. For the rock samples containing the smallest amounts of mercury, it was usual to accumulate 2500-7500 net counts above the baseline. Using the irradiation and counting conditions of this work, the sensitivity could be expressed as ranging from  $2 \times 10^3$  to  $9 \times 10^3$  counts/minute per  $\mu\text{g}$  of mercury, for the 0.28 MeV gamma-ray photopeak integrated above the interpolated baseline.

### Radiochemical Purity

Checks on the radiochemical purity of the samples counted can be made by means of chemical recycling and determination via different mercury activities.

#### PROCEDURE 19.

##### Cellulose Column Chromatography to Separate Mercury and Gold from RaDEF

Source: G. W. Warren, et al., Search for New Radioactive Nuclides in the Region of 126-Neutrons, U.S. Atomic Energy Commission Report AECU-3165 (1956).

### General Procedure

A chromatographic column of conventional design was comprised of a 3 cm pyrex glass tube, approximately 125 cm long joined to a 29/42 ground glass joint. The uppermost portion of the inner joint had been mended over and 4 holes of approximately 1 mm diameter were placed at random over the oval surface which was covered with a piece of Whatman No. 1 filter paper. The bottom portion of the inner tube had been reduced to about 7 mm diameter. The rate of flow of solvent during packing of the column was adjusted by a pinch clamp attached to a rubber hose which had been placed over the 7 mm tubing. To obtain reproducible results it was necessary to insure that the cellulose column packing was of maximum density and homogeneity, i.e., that no bubbles or cavities were present.

The column is prepared by addition of a cellulose solvent slurry to the chromatographic tube containing the solvent. The slurry is prepared by the addition of 1 part per volume of freshly screened (100 mesh) cellulose powder to 2 parts by volume of the solvent to be used as the eluant. The solvent is stirred slowly as the cellulose powder is added so that the slurry does not contain lumps of cellulose powder. The solvent layer within the column is maintained at a minimum of 5 cm above the cellulose level. Solvent is withdrawn constantly from the column until the desired or minimum flow rate has been obtained. The initial rate of flow must be fairly slow

in order to avoid cavity formation and bubbles, and to insure that the cellulose powder packs evenly. The flow rate is gradually increased as more cellulose powder is added to increase the column length, until the maximum flow rate is reached approximately 2 hours after the addition of slurry is completed. After the rate of solvent flow is constant for a period of 20 to 30 minutes, the column is ready for use. The mixture to be separated is added in HCl solution and is contained in the smallest possible volume. The solvent just covers the cellulose surface during and immediately after the addition of the sample. The band width is found to depend largely upon the volume of the solvent above the cellulose surface; for this reason the volume of the mixture and of the solvent above the cellulose surface has to be kept to a minimum in order to produce narrow zones. When the cellulose surface is exposed to air while the sample is at the top of the column, some cations, e.g., Au and Po are reduced to lower oxidation states, which are characterized by different  $R_F$  values.

To produce a clear separation by use of the cellulose column method, it is necessary that the desired species be eluted first from the column, so that the remaining ions follow at a  $R_F$  value differing by at least 0.2 from the first cation eluted.

After collection of each fraction, the receiving section of the column is removed and thoroughly washed in order to remove completely the portion of the preceding zone remaining.

The zones are identified either by scanning with a counter, spot testing, or by identifying the characteristic color of the complex ion, e.g., red:  $\text{PdCl}_4^-$ , yellow:  $\text{AuCl}_4^-$ , and red:  $\text{IrCl}_6^-$ . Mercury is identified by use of a 0.5 percent alcoholic solution of diphenyl carbazide, which results in a blue coloration of the band.

#### Separation of Hg and Pt from RaDEF

Sample consists of spend radon seeds in the presence of Au and Hg

1. Add 25 ml each of Pt, Tl, Bi, and Pb carrier.
2. Reduce solution to approximately 5 ml volume.

3. Add 10 ml aqua regia.
4. Evaporate three times with added HCl to expel HNO<sub>3</sub>.
5. Make solution 6N with HCl.
6. Add 10 ml of ethyl ether (pre-equilibrated with 6 N HCl).
7. Extract with stirring. Centrifuge. Ether Layer contains the Au-Tl fraction; Aqueous Layer contains the Pt, Pb, Bi, Hg and Po fraction.
8. Reduce aqueous solution to a 2 ml volume.
9. Add solution to a standard cellulose column.  
Band width = 5 cm, Elution rate = 2.2 ml/minute.  
Eluant - Butanol saturated with 3 N HCl.
10. Collect fractions listed below. Identify the components and discard the Au, Po, Bi and Pb fractions.

Element	Hg	Pt	Au	Po	Bi	Pb
R <sub>F</sub>	0.8	0.7	1.1	1.0	0.6	0.3

11. Reduce Hg and Pt fractions to a 2 ml volume.
12. Add 25 mg of Pb, Bi, and Au carriers.
13. Add 5 ml of aqua regia.
14. Evaporate three times with added HCl to expel HNO<sub>3</sub>.
15. Reduce solution to a 2 ml volume.
16. Repeat steps (9) through (15) twice.
17. Identify Hg and Pt fractions and mount for counting.

#### PROCEDURE 20.

##### Fast Separation of Cations Using Ascending Paper Chromatography

Source: G. W. Warren, Search for New Radioactive Nuclides in the Region of 126-Neutrons, U. S. Atomic Energy Commission Report AECU-3165 (1956).

Separations of microgram quantities of radioactive mercury, thallium, bismuth, and lead and of non-radioactive platinum, gold, copper, nickel,

cobalt, iron, cadmium, silver, and palladium in from 2 to 20 minutes can be achieved with ascending paper-chromatography using acetone containing various complexing agents as developers.

The most suitable paper for producing fast and reproducible separations is Eaton-Dikeman Grade 301, 0.1 inch thick, which had been purified by downward percolation with nitric acid, acetic acid and water. Whatman No. 1 paper without washing will give separations normally in 1 to 2 hours under identical conditions.

Separations are carried out in 10 cm diameter glass tubes about 50 cm long placed erect in a 1 liter beaker containing the developer solution. A rubber stopper containing both a glass hook for suspending the paper strip and two 6 mm glass vapor tubes is used to seal off the tube. Solvent vapors are introduced continuously by passing a small stream of air through the flask containing the boiling solvent connected to the vapor inlet of the glass chamber.

About 10 microliters of a solution containing 5 to 10 micrograms of the cations to be separated are applied to the paper so that, when suspended in the chamber, the spot would be about 1 cm above the surface of the developer. With mercury, thallium, bismuth, and lead, radioactive  $\text{Hg}^{203}$ ,  $\text{Tl}^{204}$ ,  $\text{RaE}$  and  $\text{Pb}^{210}$ , respectively, are used either at tracer concentrations or carrier-free. Prior to suspending the paper strip, the chamber is supersaturated with solvent vapors. The chamber is ready for use about 5 to 10 minutes after the solvent vapors are first introduced. Under these conditions, acetone ascends the first 20 cm of Eaton-Dikeman Grade 301 paper in about 15 minutes, whereas 1-1/2 to 2 hours are required for acetone to ascend the same distance on Whatman No. 1 paper. After a distance suitable for a separation is reached, from 5 to 20 cm depending on the  $R_F$  values for the particular developer system, the strip is removed from the chamber and either streaked with a suitable reagent to indicate the presence of active zones or scanned with a counter.

The streaking reagents used to locate the zones are as follows:

diphenyl carbazide (0.05% in ethanol) for  $\text{Hg}^+$ ,  $\text{Hg}^{++}$ , and  $\text{Tl}^{+3}$

potassium iodide (5% solution) for  $\text{Pt}^{4+}$ ,  $\text{Pd}^{++}$ ,  $\text{Au}^{+++}$ ,  $\text{Hg}^+$ ,  $\text{Hg}^{++}$ ,  $\text{Tl}^+$ ,  
 $\text{Tl}^{+++}$ ,  $\text{Pb}^{++}$ , Bi

sodium sulfide (5% solution) for Cd,  $\text{Cu}^+$ ,  $\text{Cu}^{++}$ , Co, Ni, Pb, Au,  $\text{Pt}^{4+}$ ,  
 $\text{Tl}^+$ , Bi $^{+++}$ ,  $\text{Te}^{++}$ ,  $\text{Te}^{+3}$ , Ag

dimethylamino benzalrhodamine (0.03% in ethanol) for  $\text{Hg}^+$ ,  $\text{Hg}^{++}$ , and Ag.

TABLE XLIII.  $R_F$  values for Eaton-Dikeman Grade 301 Paper.

Cations	Developer Systems									
	I	II	III	IV	V	VI	VII	VIII	IX	X
Pd	0.91	0.82	0.98	0.92	0	0.95	0.88	0.86	0.83	
Ag	0	0.40	0.44	0.45	0	0.37	0	0.23	0.96	
Cd	0.63		0.76	0.68	1.0	0.45	0.46	0.33	0.75	
Fe(II)	0.76	0.80	0.24	0.52	0	0.73	0	0.88	0.81	
Fe(III)	0.76	0.70	0	0	0	0	0	0	0.85	
Co	0.33	0.80	0.64	0.55	0	0.40	0.40	0.26	0.93	
Ni	0	0.62	0	0.17	0	9	0	0	0.91	
Cu	0.64	0.60	0	0	0	0	0	0.21	0.79	
Bi	0.93	0.93	0.98	0.96	1.0	0.98	0.92	0.91	0.91	0
Pb	0.48	0.16	0	0.35	0	0	0.25	0	0.81	0.7
Tl(I)	0.11	0.26	0.26	0.08	0	0	0	0	0.71	0.4
Tl(III)	0	0	0.26	0.45	0	0	0	0	0.70	0.4
Hg(II)	0.96		0.80	0.83		0.13	0.77	0.74	1.0	0.3
Au(III)	1.0	1.0	1.0	1.0	1.0	1.0	1.0	1.0	0.71	0
Pt(IV)	0.89	1.0	1.0	0.92	1.0	1.0	0.88	0.80	0.89	

The  $R_F$  value tabulated in Table XLIII is the ratio of the distance leading edge of a zone to the distance of the solvent front, both measured from the midpoint of the original spot. The developer systems used are as follows:

- I 50% of 6N HCl - 95% acetone
- II 5% of 0.5N HCl - 95% acetone
- III 10% of a 5% tartaric acid solution - 90% acetone
- IV 10% of a 5%  $\text{Na}_2\text{HPO}_4$  solution - 90% acetone
- V 20% methyl acetate - 80% acetone
- VI 5% of a 10% antipyrene solution - 95% acetone
- VII 5% of a 5% solution of thioacetamide - 95% acetone

- VIII 5% of a glacial acetic acid - 95% acetone
- IX 5% tartaric acid solution - (aqueous)
- X water saturated with aniline

Percentages are by volume except with the case of solids where they are by weight.

#### PROCEDURE 21.

Thermal Separation of Radiomercury from Radiosodium

Source: Reaser et al., Science 109, 198 (1949).

A number of physiological phenomena can be studied best by the simultaneous administration of two or more radioactive isotopes.

Mercury, one of the oldest of therapeutic agents, combines with other elements to form many compounds, usually organic, of definite biological interest. Its organic combinations are characterized by thermal instability, which is the basis of the following separation procedure.

Thirty samples of an aqueous Mercurhydrin preparation labelled with  $\text{Hg}^{203}$  were accurately measured onto filter paper discs and allowed to dry at room temperature. Similarly, 30 such samples of a solution of radioactive sodium ( $\text{Na}^{22}$ ) chloride were prepared, to which, after drying, was added a known amount of radioactive Mercurhydrin solution. The papers were fixed to tinned discs with rubber paper cement.

After being counted, all preparations were placed alternately in position on a sheet of aluminum measuring 18" x 12" x 3/16" and heated in an oven to 250 °C for one hour and twenty minutes. Upon removal and cooling they were again counted. Interference by the rubber cement was shown to be nonexistent.

A mean of more than 99 percent of the mercury of a Mercurhydrin preparation was driven off by heat, whereas under identical conditions a sodium preparation did not change significantly.

## PROCEDURE 22.

## Trace Mercury Determination in Liquid Metals

Source: A. A. Smales, Proceedings of the International Conference on the Peaceful Uses of Atomic Energy, Vol. 9, p. 273 (1955).

Approximately 1 gram of the sample is dissolved in methanol and titrated accurately with standardized acid to a methyl red endpoint. On the basis of a 1:2 sodium-potassium ratio, the equivalent weight of the alloy samples was taken as 33.732 grams. To the titrated solution, add 30 mg of  $\text{Hg}^{++}$  carrier and 3 ml of concentrated HCl, then evaporate carefully to incipient crystallization. Dilute the sample to about 20 ml and add an excess of stannous chloride to precipitate all mercury in the metallic form. Centrifuge, discard the supernate and dissolve the metal in 3 drops of concentrated hydrochloric acid and 2 drops of concentrated nitric acid with the aid of gentle heating. Dilute again to 20 ml and carry out two silver chloride scavenges using 5 mg  $\text{Ag}^+$  each time and digest the precipitates for a few minutes on a boiling water bath before centrifuging. Test for complete removal of silver carrier by adding a further drop of concentrated HCl after the last centrifuging. Discard the scavenging precipitates and add 2-3 small drops of 6N stannous chloride reagent to the supernate. Centrifuge the mercurous chloride precipitate, wash twice with 10 ml portions of water and once with methanol. Discard all supernates. Slurry the mercurous chloride with methanol and transfer to the bottom of a long cold finger condenser packet (17 x 2 cm) using a long-tipped dropping pipette for the purpose. Evaporate the alcohol with gentle heating. Cover the solid mercurous chloride with powdered iron, insert the cold finger, and adjust an asbestos shield around the jacket about one-half inch above the bottom of the cold finger. Apply increasing heat from a bunsen burner until the iron is glowing red and maintain the flame for a few minutes to drive all mercury onto the tip of the cold finger. Allow to cool completely before removing the jacket and replacing it with another having 7 drops of a concentrated



HCl-HNO<sub>3</sub> mixture in the bottom. Gently distill the acid onto the cold finger (water flow now shut off) until the gray film of mercury is dissolved. Cool again and dismantle, rinsing the cold finger thoroughly as it is withdrawn. Transfer the diluted acid washings to a 40 ml centrifuge tube, and add 2-3 small drops of stannous chloride reagent. The precipitate should be white or at worst faintly gray. If an excess of stannous reagent has made it gray, the precipitate may be centrifuged off, redissolved in a few drops of aqua regia and reprecipitated with less stannous chloride. Centrifuge, wash twice with water, once with alcohol and slurry onto a weighed counting tray and dry under an infra-red lamp. Weigh, and correct the activity for chemical yield.

#### PROCEDURE 23.

A Method for the Separation of Mercury Isotopes from Irradiated Gold

Source: W. Parker, Nucl. Instr. Methods 8, 354 (1960).

The purpose of this note is to make known the constructional details of an apparatus developed for the separation and consequent deposition of Hg isotopes from irradiated Au. The apparatus, seen in Figure 47, functions as a vacuum evaporator and can be put together in a few hours by a machine shop and, when complete, may be relied upon to give reproducible results. Part of the apparatus forms a dewar flask constructed by placing a small brass cup, A, within a larger one, B. Cup A has a diameter of 40 mm's, the larger cup, B, 70 mm's. The bottom of A is drilled and tapped to take a threaded rod, C. Hard soldered to B are two half-inch standard vacuum connections E and D. The male counterpart of D is fitted with a quartz tube, F, fastened by means of thermal cement G, while the second vacuum connection E, is for evacuating the system.

The operating procedure is as follows: Part of all of the Au target is placed in the quartz tube. A gold spot, the diameter of which will

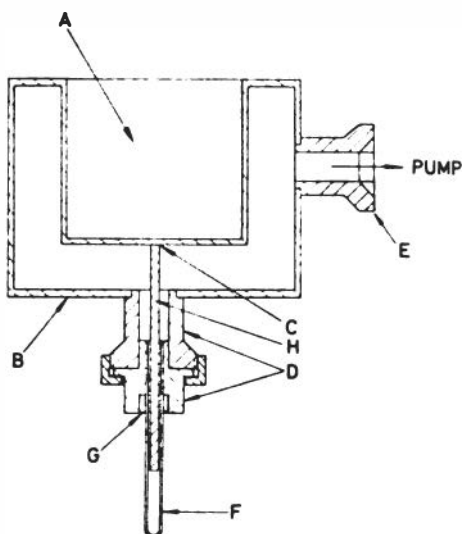

Figure 47. Vacuum evaporation apparatus for mercury separations.

deposited on the source requirements, is vacuum deposited onto a suitable piece of mylar. The unthreaded end of the rod is smeared with vacuum grease and brought into contact with the uncoated side of mylar, the surplus mylar being pleated along the sides of the rod. The rod and quartz tube can now be screwed into their respective positions. After pumping for some minutes the rotary pump is isolated by means of a valve and the dewar filled with either dry ice and alcohol or liquid air. A bunsen burner is suitable as a heat source and only a small flame necessary.

Deposition times were from 15 to 60 minutes after which the mylar was removed and stretched over a suitable holder. Using the described apparatus efficient depositions have been carried out, and when necessary, 100% separation achieved.

#### PROCEDURE 24.

Carrier-Free Separation of Mercury Isotopes by Volatilization from Gold or Thallium Targets

Source: R. W. Fink and E. O. Wiig, *J. Am. Chem. Soc.* 74, 2457 (1952).

A portion of the gold or thallium target is placed in the chamber of a stainless steel vaporizer. A clean platinum collecting plate is cemented to a stainless steel water cooled cold finger. The bottom of the apparatus is heated for about 5 minutes with a Fisher burner to not more than  $-400^{\circ}\text{C}$ .

The vapor pressure of pure mercury is 1572.1 mm at  $400^{\circ}\text{C}$ , of pure gold only 0.001 mm at  $1292^{\circ}\text{C}$ , and of pure thallium only 0.001 mm at  $413^{\circ}\text{C}$ . This large difference of vapor pressure between mercury and gold and thallium at  $400^{\circ}\text{C}$  affords a mercury volatilization separation procedure which is quick, carrier-free, and excellent with respect to purity.

#### PROCEDURE 25.

##### Radiochemical Mercury Separation

Source: W. W. Meinke, Chemical Procedures Used in Bombardment Work at Berkeley, AECD-2738, p. 232, (1949).

Element separated: Mercury

Procedure by: R. W. Fink and  
S. G. Thompson

Target material: Gold or platinum

Time for sep'n: from 1 to 5 min.

Type of bbd: Protons on gold or  
 $\alpha$ - particles on Pt, but not vice  
versa.

Equipment required: mercury volatilizer  
(see astatine boiler)

Yield: Enough activity to work with but by no means quantitative. For more yield, heat longer.

Degree of purification: Extremely pure.

Advantages: For short Hg half-lives when quick samples are desired for counting. Definitive purity.

##### Procedure:

1. The target is introduced into the chamber of the Mercury vaporizer. A thin Pt collecting plate is put on the bottom of the water-cooled cold finger with duco cement.
2. The Hg is then vaporized by a bunsen flame, and is collected in high specific activity on the plate.

Remarks:

- a. Caution must be exercised not to open the vaporizer until it has thoroughly cooled, lest the hands become covered with unwashable mercury activity which spews forth when the vaporizer is hot.
- b. The vapor pressure of Hg at only 400 °C is 1574.1 mm of Hg, over 2 atm.; while that of molten gold at 1292 °C is only 0.001 mm. Hence, at 1000 °C, a complete separation is attained.  
Tl if present will follow the Hg in this procedure.

PROCEDURE 26.

Steam Distillation of Mercury

Source: J. R. DeVoe, NAS-NS-3108 (1962).

Steam distillation of mercury in the presence of a reducing agent was first proposed by Miller (W. L. Miller & L. E. Wachter: Anal. Chem. 22, 1312, 1950), who claimed quantitative recoveries. In this procedure the reducing agent (either  $\text{SnSO}_4$  or  $\text{SnCl}_2$ ) was added in one step instead of dropwise. A micro-Kjeldahl apparatus was used. The distillation process was monitored with  $\text{Hg}^{197}$  -  $\text{Hg}^{203}$  tracer.

Procedure

Introduce the solution into the micro-Kjeldahl apparatus and add  $\text{H}_2\text{SO}_4$  to make the solution 0.5N in acid. The total volume should not exceed 20 ml. Add 20 ml  $\text{SnSO}_4$  or  $\text{SnCl}_2$  solution. Steam distillation is carried out from 15 to 20 minutes, the tip of the cooler plunging into 25 ml of a  $\text{H}_2\text{SO}_4$  -  $\text{KMnO}_4$  solution, cooled in ice water.

Reagents

1. Concentrated  $\text{H}_2\text{SO}_4$  analytical grade.
2. Reducing agent:
  - a) 10 g  $\text{SnSO}_4$  dissolved in 100 ml  $\text{H}_2\text{O}$  + 1 drop 36 N  $\text{H}_2\text{SO}_4$ ; filter off residue;

- b) 125 g  $\text{SnCl}_2 \cdot 2\text{H}_2\text{O}$  are dissolved in 100 ml of 12 N  $\text{HCl}$  and diluted with water to 1000 ml;
3.  $\text{H}_2\text{SO}_4$  -  $\text{KMnO}_4$  mixture: 250 ml 3.5 N  $\text{H}_2\text{SO}_4$  + 250 ml 0.8 N  $\text{KMnO}_4$ .

#### PROCEDURE 27.

##### Separation of Mercury Deposit from Metallic Copper

Source: J. R. DeVoe, U. S. Atomic Energy Commission Report AECU-4610, December 1959.

##### Method

This method uses the well-known fact that copper metal will reduce mercury onto its surface from aqueous solution. The copper strip is then heated to remove the mercury.

1. To a 50 ml round bottom centrifuge cone, add carrier-free  $\text{Hg}^{203}$  tracer solution, in known amount for yield determination. If a decontamination factor is to be measured, use inactive mercury plus a radioisotopic tracer of the contaminant.

2. Add sufficient acid to bring total volume to 2 ml of 0.15N  $\text{HNO}_3$ .

3. Prepare an 8 mg Cu foil, 0.5  $\text{cm}^2$  (10 mils thick), by washing in 1N  $\text{HNO}_3$  to clean the surface; rinse with distilled water and add to the centrifuge cone.

4. Stir slowly for about 20 minutes and wash six times with distilled water and once with acetone.

5. Transfer to a carbon rod furnace, and heat to 100  $^{\circ}\text{C}$  for three minutes.

6. Collect the mercury on Teflon film. Cut out the area where collection occurs, and count in a scintillation well counter.

##### Notes

1. The yield of the separation with 76  $\mu\text{gm}$  of Hg in 0.15N  $\text{HNO}_3$  is  $72 \pm 3\%$ .

Error is standard deviation for 5 experiments.

2. Decontamination factors for a number of elements are listed in Table XLIV.

Remarks

Method was tested with Hg carrier in the 0.2 µg range. Quantitative results were obtained for up to 78 µg.

Alternative Procedure

Distillate is collected in two one ml portions of the H<sub>2</sub>SO<sub>4</sub> mixture in 2 consecutive micro-traps.

TABLE XLIV. Decontamination factors for the separation of mercury onto copper and the distillation of mercury.

Contaminant	Amount (µg)	Decontamination Factors		Total
		Chemical Redn.	Distillation	
Ag <sup>110</sup>	200	1.2	2x10 <sup>4</sup>	2.4x10 <sup>4</sup>
Ba <sup>140</sup>	C.F.	3x10 <sup>2</sup> (2.3x10 <sup>5</sup> )	3.3x10 <sup>2</sup>	10 <sup>5</sup> (7.6x10 <sup>7</sup> ) <sup>*5</sup>
Au <sup>198</sup>	220	40	4x10 <sup>3</sup>	1.6x10 <sup>5+2</sup>
Ce <sup>144</sup> -Pr <sup>144</sup>	C.F.	1.2x10 <sup>3</sup>	2.3	2.8x10 <sup>3</sup>
Cd <sup>115m</sup>	190	1.6x10 <sup>2</sup>	3.4 *3	5.4x10 <sup>2</sup>
Co <sup>60</sup>	7.4	10 <sup>5</sup>	5	5x10 <sup>5</sup>
Cr <sup>51</sup>	5	2.5x10 <sup>3</sup>	6	1.5x10 <sup>4</sup>
Cs <sup>134</sup>	2.5	3x10 <sup>3</sup>	2.3	6.9x10 <sup>3</sup>
Cu <sup>64</sup>	65	1.2x10 <sup>2</sup>	1.4x10 <sup>2</sup>	1.7x10 <sup>4</sup>
In <sup>114</sup>	4.6	10 <sup>5</sup> (2x10 <sup>7</sup> ) <sup>*4</sup>	10 <sup>2</sup>	10 <sup>7</sup> (2x10 <sup>9</sup> )
Ir <sup>192</sup>	0.2	2x10 <sup>4</sup>	1.4	2.8x10 <sup>4</sup>
Nb <sup>95</sup>	8	3x10 <sup>3</sup>	10	3x10 <sup>4</sup>
Pd <sup>109</sup>	50	1.4	1.7x10 <sup>5</sup>	2.4x10 <sup>5</sup>
Ru <sup>106</sup>	2	32	350	1.1x10 <sup>4</sup>
Se <sup>75</sup>	3.5	6.5	2.8x10 <sup>3</sup>	1.8x10 <sup>4</sup>
Sb <sup>124</sup>	0.6	2.8x10 <sup>2</sup>	4.7	1.3x10 <sup>4</sup>
Sn <sup>113</sup>	500	1.3x10 <sup>3</sup>	10	1.3x10 <sup>4</sup>
Ta <sup>182</sup>	4	-	-	--*1
Tl <sup>204</sup>	400	4x10 <sup>4</sup>	2.5	10 <sup>5</sup>
Zn <sup>65</sup>	180	4.3x10 <sup>3</sup>	4.7	2x10 <sup>4</sup>
Zr <sup>95</sup>	8	2.7x10 <sup>3</sup>	14	3.8x10 <sup>4</sup>

- \*Notes: 1. Fluoride complexing agent for Ta interferes with the mercury yield.  
 2. Mercury comes off at 350 °C.  
 3. Mercury comes off at 220 °C.  
 4. Start with 5 x 10<sup>6</sup> and (4 x 10<sup>6</sup>) (C/M resp.)  
 5. Start with 1.9 x 10<sup>6</sup> and (1.9 x 10<sup>9</sup>) (C/M resp.)

## PROCEDURE 28.

Determination of Mercury in Biological Materials by Activation Analysis

Source: B. Sjostrand, Anal. Chem. 36, 814 (1964).

Sample and Standard Preparation

Because of the volatility of mercury compounds, samples weighing 0.3-1 gram must be sealed in quartz tubes before irradiation. The tubes must

be carefully cleaned before filling them with the samples, and precautions should also be taken to avoid contamination inside the tube. A sealing technique is presented in the Appendix I to this Procedure.

Mercury standards are prepared from an aqueous  $\text{HgCl}_2$  solution and should contain about 1  $\mu\text{g}$  of the element. A known amount of the freshly prepared standard solution is pipetted on a small filter paper circle. About the same volume of saturated  $\text{H}_2\text{S}$  solution is added to the filter paper. After careful drying, the filter paper is placed in a quartz tube and sealed as described in Appendix I. During neutron irradiation samples and standards should be located as close as possible to each other to minimize the effects of flux gradients and flux depression in the reactor. After irradiation the samples should be allowed to cool for at least ten days.

In breaking the tubes, precautions must be taken to avoid loss of gaseous components of the sample formed by the heat in the reactor. The tubes should therefore be opened in nitric acid in the following way:

After careful cleaning of the tube to remove surface contamination, it is inserted in a piece of plastic tube, sealed at one end. The plastic tube is then filled with oxidation mixture to cover the quartz tube completely. The open end of the plastic tube is then sealed with a Hoffman clamp. Pressure is applied to the tube with a pair of tongs to crush the quartz tube. The sample is then immediately mixed with the acid and the gases are absorbed by shaking the tube. The plastic tube is then opened and the sample transferred to the distillation flask. The plastic tube should be carefully rinsed with a few milliliters of the oxidation mixture. It is not necessary to separate the sample from the crushed quartz tube.

### Radioactivity Measurement

The gamma spectrometry is performed using a multichannel analyzer and a 3 x 3 inch  $\text{NaI(Tl)}$  detector. The  $\text{Hg}^{197}$  activity is determined by measuring the area under its 77-keV peak. Standards are counted in exactly the same geometry as the samples.

### Digestion of Sample

Transfer the sample to the flask after breaking the tube as described.

Add carrier solutions of  $\text{HgCl}_2$  and  $\text{As}_2\text{O}_3$ , 20 mg of each element. Add oxidation mixture to make 15 ml. Connect the flask to the Bethge apparatus. Pour a few milliliters of water into the splash head.

Close the tap and heat the flask until the nitric acid has distilled into the reservoir. Allow the temperature to rise to over  $300^\circ\text{C}$  and boil the sample in the sulfuric acid remaining.

When cold, run the distillate back into the flask.

Repeat the heating cycle until the solution is completely clear and colorless when boiling under reflux.

### Separation of Mercury

Add a mixture of 5 ml of 70 percent perchloric acid and 0.5 grams of glycine in 5 ml of water to the dissolved sample.

Apply heat to the flask. When the solution is boiling under reflux, close the tap and collect the mercury fraction in the reservoir. Interrupt the distillation when the temperature exceeds  $250^\circ\text{C}$ .

Tap the distillate into a 600-ml glass beaker. Dilute the distillate to about 300 ml with water. Deposit mercury on a  $1 \times 3$  cm, 0.02 mm thick gold foil in 15-20 hours of electrolysis at 4-6 volts and a current of 0.3-0.5 amps. When the electrolysis is completed, neutralize the electrolyte with ammonium hydroxide, using phenol red as an indicator, before the current is interrupted.

Rinse the gold foil with distilled water and transfer the foil to a beaker containing ethyl alcohol, where it is stored until the weighing can be performed. Leave the foil to dry in the air for a few minutes. Do not dry the foil by heating. Determine weight increase of the foil and calculate the chemical yield by comparison with the amount of mercury added as carrier. Seal the foil in a plastic bag. Measure the  $\text{Hg}^{197}$  activity by  $\gamma$ -spectrometry.



## APPENDIX I

Method for Sealing Quartz Tubes.

Since the sealing in quartz tubes in the case of mercury-containing materials may not be trivial, our method for this will be described shortly.

The tubes used were made from ordinary quartz glass tube, available here in 0.5 m lengths. The tubes were cut to about 60 mm, sealed at one end and carefully cleaned (chromic acid, distilled water, alcohol, annealing) before inserting and weighing the samples. The tube length, of course, depends on the size of the irradiation can used but should be at least 40 mm to insure that no radiant heat damage of the sample occurs during the sealing process. For the same reason, samples should be placed only in the lower part of the tube. The sealing was made under water cooling of the tube's sample region by means of some kind of high temperature burner ( $>1700^{\circ}\text{C}$ ). Up to now, we have used an ordinary welding burner (acetylene-oxygen) for this purpose but a hydrogen-oxygen burner might be still more effective. The sealing must be done rapidly (in a few seconds) to prevent heat from spreading to the tube's sample region.

The apparatus shown in Figure 48 has been used for sealing several hundreds of samples without any indication of serious heating effects. The apparatus consists in its simplest form of a small water-filled can with a hole in the cover fitting the tube or, still better, some kind of spring system fitting a certain range of tube diameters to keep the tube in the center of the can. The can is mounted vertically and rotated slowly (20-30 rpm) around its axis by means of a small motor. The tube is inserted in the

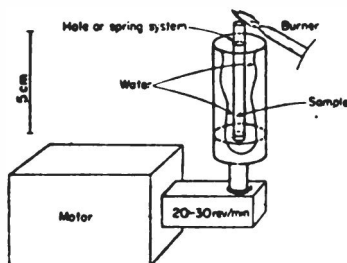

Figure 48. Sketch illustrating the quartz tube sealing technique.

can (4/5 of the tube under water) and is then ready for sealing. The water should be changed frequently when sealing a number of tubes in series.

## APPENDIX II

### Decomposition and Distillation Apparatus

The decomposition of the organic material must, because of the volatility of the mercury compounds, be carried out in a closed system. The decomposition and the distillation should therefore be performed in the apparatus shown in Figure 49.

This apparatus, described by Bethge,<sup>214</sup> consists of a 150-ml distillation flask, A, a reservoir, B, with a two-way tap and a bypass, a reflux condenser, C, and a splash head, D. With the tap in the position indicated in the

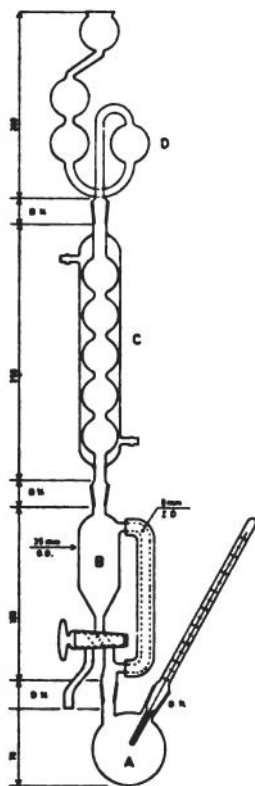

Figure 49. Apparatus for controlled decomposition of organic materials, also used as distillation apparatus.

Bypass insulated with asbestos yarn.

All measures in millimeters.

See page 201 for copyright citation.

figure, the apparatus will function as an ordinary reflux device. If the tap is turned through  $90^{\circ}$ , a liquid heated in A will distill through the bypass, condense, and collect in B, from where the distillate may be run back into the flask or out through the side arm. The apparatus consists, with the exception of B, of easily available standard parts.

#### Method for Destruction of Organic Matter and the Recovery of Mercury.

The oxidation mixture consists of concentrated nitric acid containing 5 to 10 percent of concentrated sulfuric acid. Fifteen milliliters of the mixture should be used for samples weighing up to 1 gram. The sample is mixed with the oxidation mixture in flask A. The tap is closed and heat applied to the flask until all the nitric acid has distilled into the reservoir. The temperature is raised to over  $300^{\circ}\text{C}$ , and the sample is boiled for a few minutes in the sulfuric acid remaining in the flask, before the distillation is interrupted. When cold, the distillate is run back into the flask and the heating cycle is repeated until the solution is completely clear and colorless when boiling under reflux. The temperature rise at the end of each heating cycle seems to accelerate the destruction of organic matter, so that the destruction can be completed within half an hour or less.

The splash head at the top of the Bethge apparatus should contain a few millimeters of water.

#### Distillation of Mercury

A mixture of perchloric acid and a water solution of glycine is added to the dissolved sample in the flask. The flask is heated and the liquid distilled into the reservoir. As seen from Figure 50, the distillation must not be interrupted until the temperature exceeds  $250^{\circ}\text{C}$ . The distillate, representing the mercury fraction, is run off through the side arm and treated separately. The role of the glycine added is to reduce the perchloric acid to produce hydrochloric acid, which then reacts with the mercury to give a volatile compound. As this formation seems to take place mainly at temperatures above  $120^{\circ}\text{C}$ , addition of hydrochloric acid would not produce

volatile mercury compounds when heated, because the hydrochloric acid would distill over before the temperature is attained at which volatile mercury compounds are formed.

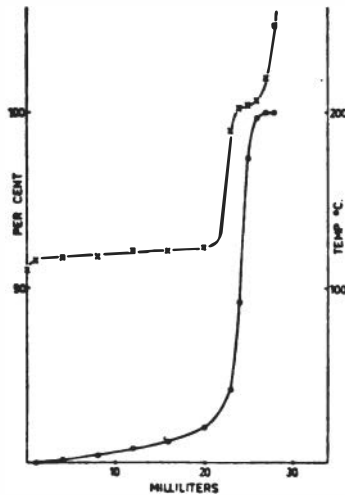

Figure 50. Distillation curve for mercury.  
(% of mercury distilled, X Temperature of Fumes)  
See page 201 for copyright citation.

From Figure 50 it is seen that only 10 percent of the mercury is removed with the first 20 ml of liquid distilled in the temperature range below 125 °C; about 80 percent of the mercury distills between 190 °C and 210 °C. The volume of liquid distilled in that temperature range is about 4 ml and the distillation of mercury is 100 percent complete between 220 ° and 250 °C. From these results the importance of not interrupting the distillation too early is obvious.

#### PROCEDURE 29.

Radiochemical Method for Determination of Arsenic, Bromine, Mercury, Antimony, and Selenium in Neutron-Irradiated Biological Material

Source: K. Samsahl, Anal. Chem. 39, 1480 (1967).

Neutron activation analysis of trace elements which form volatile compounds may be simplified in many matrices by introducing a distillation step. The distillate may then be analyzed by gamma spectrometry, either

directly or after further chemical separation steps. The procedure given below is based on the simultaneous distillation as oxides or bromides of As, Br, Hg, Sb, and Se.

### Apparatus

The distillation apparatus, shown in Figure 51 is made of borosilicate glass, and ungreased B 14, B 10, or spherical joints are used as connections. The neck of the distillation flask, A, is surrounded by three turns of a coil with an inner diameter of 5 mm. This coil, which reduced spray during the distillation, forms the direct connection to the receiver, B.

Reagents for flask A are added to a small funnel, H, and then sucked in through a capillary tube which continued along the walls and ends near the bottom of the flask. The distillation flask is surrounded by a borosilicate glass tube in order to ensure sufficient isolation during the distillation. The flask is heated with hot air from a Bunsen burner.

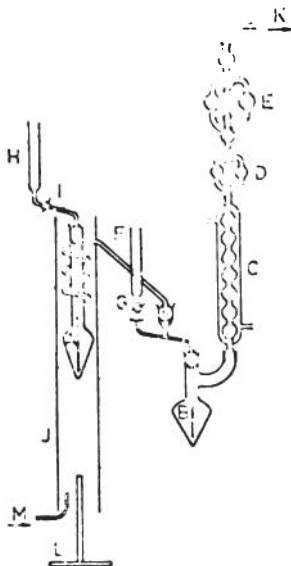

Figure 51. Distillation Apparatus  
See page 201 for copyright citation.

- A. Distillation flask, 15-ml volume, 175 mm long, B 14 joint
- B. Receiver flask, 30-ml volume, 120 mm long, B 14 joints
- C. Reflux condenser, 150 mm long, B 10 and B 14 joints
- D. E. Traps for 2 and 5 ml, respectively, B 10 joints

- F. H. Funnels, 10 x 100 mm
- G. I. Stopcocks
- J. Borosilicate tube, 45 x 380 mm
- K. Arrow points to water suction pump
- L. Bunsen burner
- M. Compressed Air

The receiver flask, B, is connected in its turn to a reflux condenser, C, two U-tubes, D and E, and a water-suction pump, K. Reagents are sucked into the flask via funnel F.

### Procedure

The following method is suitable for soft animal tissue samples and may also be used without modification for hard animal tissue containing maximally 6 to 7 mg of Ca. However, it has not been sufficiently tested with plant samples rich in silica.

Preparation and Irradiation. Maximally 200 mg of a dried, soft animal tissue sample is sealed in a small quartz tube and irradiated together with standards of As, Br, Hg, Te and Se for 1 to 2 days with a thermal neutron flux of  $2 \times 10^{13}$  n/cm<sup>2</sup>·sec. The high radioactivity of the sample is then allowed to decay for 2 to 3 days before starting the chemical separation. Further details about the preparation of samples and standards as well as the irradiation are given in reference 215.

### Decomposition and Distillation

To flask B are added 1 ml of 1 to 1 H<sub>2</sub>SO<sub>4</sub> and 1 ml of 30% H<sub>2</sub>O<sub>2</sub>. To trap D is added 2 ml of 1 to 10 H<sub>2</sub>SO<sub>4</sub> and to E, 5 ml of 6N NaOH. A faint stream of air is now maintained through B, C, D, and E.

The quartz tube with the sample is rinsed with acid and water and placed in liquid nitrogen for a short time. The ampoule is then immediately broken. The sample is transferred to the distillation flask, A, care being taken that glass pieces from the broken tube do not accompany the sample. Fifty microliters of a 48% HBr carrier solution containing 50 µg each of As<sup>+5</sup>, Hg<sup>+2</sup>, Sb<sup>+5</sup>, and Se<sup>+4</sup> is then added and the flask is closed. If non-

distillable elements are to be determined simultaneously, further carrier additions should be made at this juncture.

Through funnel H is now added, with suction, 2 ml of 30 to 33% fuming  $\text{H}_2\text{SO}_4$ . Stopcock I is then closed and G opened, thus maintaining a slow stream of air through the receiver system.

The mixture is very carefully heated with a small flame placed a few centimeters below the lower end of the glass tube surrounding the distillation flask. This critical initial heating stage must be watched and regulated to obtain an even release of gases without excessive spattering of material into the flask coil. After about 10 minutes the excess of  $\text{SO}_2$  and  $\text{SO}_3$  has been transferred to the receiver. During the next 10 minutes, heating of the contents of flask A is successively increased to the boiling point. The carbonization is then finished by a short vigorous boiling of the mixture in order to bring down any material spattered around in the flask. The heating is then interrupted and the contents of the flask are cooled to room temperature by means of a blast of compressed air (I open, G closed). One milliliter of 30%  $\text{H}_2\text{O}_2$  is added to the flask through tube H. When the reaction has ceased (G open, I closed), the mixture is heated to incipient fumes of  $\text{SO}_3$ . Without interrupting the heating, the straw-yellow solution is made completely clear by slowly adding in small drops through tube H about 0.75 ml of 30%  $\text{H}_2\text{O}_2$ . Finally, the solution is cooled to room temperature with compressed air. To the wet-ashed sample solution is added 0.5 ml of 48% HBr. To receiver flask B is added 1 ml of 30%  $\text{H}_2\text{O}_2$ . The additions are followed by strong heating of the solution until boiling, concentrated  $\text{H}_2\text{SO}_4$  just begins to distill (I closed, G open). After cooling and addition of a new portion of 0.5 ml of 48% HBr to the flask, the distillation is repeated in the same way for a second and a third time. After the third addition of HBr the solution is heated until 0.5 ml of  $\text{H}_2\text{SO}_4$  is left in the flask.

The distillation procedure is now finished. The 0.5 ml of  $\text{H}_2\text{SO}_4$  solution remaining in distillation flask A contains the greater part of the trace elements present in biological material. The subdivision of

the distilled trace activities as As, Br, Hg, Sb, and Se into four different groups is described below.

**Separation of Bromine.** While maintaining a faint stream of air through B, C, D, and E the contents of flask B are heated to the boiling point, and heating is continued until the solutions in B and D are completely colorless. This takes 5 to 10 minutes. At this point 95 to 99 percent of the  $\text{Br}^{82}$  activity has been expelled and quantitatively absorbed in trap E.

**Separation of Antimony, Arsenic, Mercury and Selenium.** The trace activities of antimony, arsenic, mercury, and selenium remaining in flask B after the volatilization of bromine are subdivided into three different groups by selective sorption steps in a series of three small anion-exchange columns. The separation is performed simultaneously and automatically with a proportioning pump apparatus. The system is schematically shown in Figure 52.

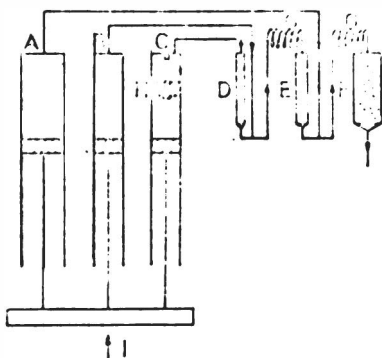

Figure 52. Scheme of the anion-exchange separation system.

See page 201 for copyright citation.

- A. Piston barrel, 28 x 150 mm
- B. C. Piston barrels, 20 x 150 mm
- D. 5 x 50 mm, Dowex 2 ( $\text{HSO}_4^-$ , 200 - 400 mesh)
- E. 7 x 50 mm, Dowex 2 ( $\text{Cl}^-$ , 200 - 400 mesh)
- F. 18 x 50 mm ( $\text{Br}^-$ ,  $\text{Cl}^-$ , 200 - 400 mesh)
- G. Mixing coils, 5 turns, 15-mm outer diameter
- H. Piston with rubber stopper
- I. Perspex plate, 15 mm thick



The working principle as well as the constructional details of this kind of machine has been described in reference 216.

The anion-exchange column, D, is prepared with a few milliliters of 3.6N  $H_2SO_4$ , column E with 4.5N HCl, and column F with a mixture containing equal volumes of 4.5N HCl and 48% HBr. The piston barrel, A, is filled with 48% HBr and B with 9N HCl. Barrel C, finally, contains both the sample solution and a washing solution. The sample solution is prepared by adding to the mixture of the acid distillate in receiver B and the contents of trap D 0.25 ml of 8N HCl, followed by dilution to 20 ml with  $H_2O$ . This solution, about 3.5N in  $H_2SO_4$  and 0.1N in HCl, is transferred to barrel C above its upper piston, H, while the washing solution consisting of 10 ml of 0.1N HCl occupies the space between the two pistons of the barrel.

Plate I is now forced upwards at a predetermined, constant speed corresponding to the delivery of the sample solution to column D at a rate of approximately 1 ml per minute. The amounts of acid between the columns, injected simultaneously via barrels A and B, make the influent solution about 4.5N in HCl for column E and 2.3N in HCl and 4.5N in HBr for F, respectively. When the sample solution has been forced out of C, a small glass rod in the bottom of the barrel automatically pushes out the rubber stopper in piston H, thus giving free passage for the subsequent washing solution. After about 30 minutes the sample and the washing solution have passed through the system of ion-exchange columns and the machine stops.

After the draining of the columns, the resin phases are transferred to polyethylene tubes, homogenized by means of the corresponding influent solutions, and counted with gamma-ray spectrometry. The  $Br^{82}$  activity in trap E is measured after appropriate dilution with water. Quantitative results are obtained by comparison with the standards.

A peristaltic pump may also be used for these separations.

The main disadvantage of the present method, and of distillation procedures in general, is the difficulty of introducing automatized operations. In the serial analysis of strongly irradiated biological

samples this is a drawback, owing to the high radiation levels, among other things. Some improvements on the present method along this line might include the fast destruction of organic matter with  $\text{Na}_2\text{O}_2$  fusion and subsequent distillation of bromides from acid solution with a continuous stream of dry HBr gas.

#### PROCEDURE 30.

Determination of Trace Elements in Stone Meteorites by Activation Analysis.  
I. Selenium, Arsenic, Antimony, Tin, and Mercury.

Source: W. Kiesel, Z. Analyt. Chem. 227, 13 (1967).

After irradiation with thermal neutrons in a reactor, traces of selenium, arsenic, antimony, tin, and mercury are separated from their respective meteorite or mineral matrices by distillation of the halides.

#### Standards

**Selenium.** Anhydrous  $\text{Na}_2\text{SeO}_3$  (Fluka) was dissolved in water. The Se concentration was determined in two ways: gravimetrically by precipitating metallic Se with  $\text{SO}_2$  from a strongly hydrochloric acid solution and by iodometric titration in 1.5 N  $\text{HNO}_3$ .

**Mercury.** Analytical grade  $\text{HgCl}_2$  (Merck) was dissolved in water, slightly acidified with HCl. The mercury concentration was determined by adding a known excess 0.1 M  $\text{ZnSO}_4$  solution, adjusting the pH to 10 and back titrating with 0.1 N EDTA solution using Eriochrome Black T as indicator.

**Arsenic.** A weighed amount of  $\text{As}_2\text{O}_3$  (Merck) was dissolved in NaOH.

**Antimony.** Analytical grade  $\text{SbCl}_3$  (Merck) was dissolved in HCl; its concentration was determined by titration with 0.1 N  $\text{KBrO}_3$ .

**Tin.** Metallic tin of a purity of 99.9995 percent (Unterharzer Berg-und Hüttenwerke GmbH, Goslar) was dissolved in HCl which contained some free chlorine.

#### Activation

Samples and standards were sealed in quartz ampoules and were irradiated for 60 hours in a thermal flux of  $2 \times 10^{13}$  neutrons/cm<sup>2</sup> sec.

Before analysis, samples and standards were allowed to cool for 10-15 hours.

#### Separation by Distillation

After opening the quartz ampoules, the samples, measured volumes of carrier solutions, and 10 ml of concentrated  $H_2SO_4$ , were placed in an all-quartz distillation apparatus. Nitrogen was passed slowly through the apparatus while the temperature was raised to about  $200^\circ C$ . Through a funnel 20 ml of a 3:1 mixture of HCl and HBr was added dropwise to the sample. The distillate passed through a condenser and was collected in an ice cooled solution of dilute HCl in which a few crystals of  $KBrO_3$  had been dissolved. After the addition of the HCl-HBr mixture was complete, heating was continued for another 15-20 minutes or until  $SO_3$  fumes were given off. All volatile components of the samples now had been volatilized and were in the distillate. At times metallic Se deposited in the condenser. In this case, the Se was dissolved by placing a few  $KBrO_3$  crystals inside the distillation head and washing with 7 N HCl.

#### Separation of Se and As from Sb, Sn, and Hg

In the distillate which now has a volume of 20-30 ml selenium is precipitated with  $SO_2$  after adding 5 ml of 7 N HCl and heating to  $70^\circ C$ . The solution with the Se precipitate is allowed to cool, then Se is filtered. The Se need not be reprecipitated if the concentration of Sb and Hg in the distillate is below  $10\ \mu g$ , and the concentration of Sn below  $100\ \mu g$ . The filtrate is adsorbed on Dowex 1-X8. The anion exchange column has an i.d. of 7 millimeters and contains 2.5 grams of 100-200 mesh Dowex 1-X8 which had been converted to the chloride form by washing with 7 N HCl.

Arsenic is eluted with 3 N HCl and precipitated as  $As_2S_3$ . Antimony, tin and mercury remain adsorbed on the anion exchanger.

#### Separation of Sb, Sn, and Hg

Two ion exchange methods for separating Sb, Sn, and Hg from each other are given below.

a. Ascorbic Acid Method. The distribution coefficient of Sb as a function of normality of HCl shows a characteristic minimum of 3.5 at 0.4 N HCl in

presence of 10 percent ascorbic acid. Thus, Sb is eluted at 0.4 N HCl. At this molarity, the distribution coefficient of Hg is not different from that in pure HCl of the same acidity whereas that of Sn is displaced toward lower values. Tin and mercury remain adsorbed. Tin can now be eluted with 22 N H<sub>3</sub>PO<sub>4</sub>. The distribution coefficient for Hg is still high enough that this element is retained on the column. To elute Sn completely from the column, about 60-70 ml of 22 N H<sub>3</sub>PO<sub>4</sub> are necessary. The column then is washed with 3-4 ml 1 N HCl to remove H<sub>3</sub>PO<sub>4</sub>. Finally, mercury is eluted with 7 N HNO<sub>3</sub>.

The disadvantage of this separation method is that the volume of 0.4 N HCl (10 percent ascorbic acid) required to elute Sb is about 130-150 ml. Since the rate of elution should be one drop in about 4 seconds, the separation takes rather long. Furthermore, the elution of Sn is almost as time consuming.

b. Ammonium Fluoride Method. The distribution coefficient for Sb can be decreased appreciably in NH<sub>4</sub>F-HCl solutions over that in HCl solutions, hence the volume of HCl to elute Sb can be reduced to 10 to 15 ml of eluant. The optimum elution conditions are 0.4-0.5 N in HCl in 10 percent NH<sub>4</sub>F. The distribution coefficient is 1.7. Tin is eluted with 22 N H<sub>3</sub>PO<sub>4</sub> and Hg with 7 N HNO<sub>3</sub>.

The dependence of the distribution coefficients for Sb, Sn, and Hg on the various eluants used in the two methods described are summarized in Figure 53. A flow chart for the separation of As, Sb, Sn, Hg, and Se is given in Figure 54.

#### PROCEDURE 31.

Activation Analysis of Mercury in High Purity Bismuth

Source: J. I. Kim and J. Hoste, Anal. Chim. Acta 35, 61 (1966).

Displacement of mercury ions by more electro-negative metals has been applied by several authors.<sup>217,218,219</sup> With regard to the sample solution,

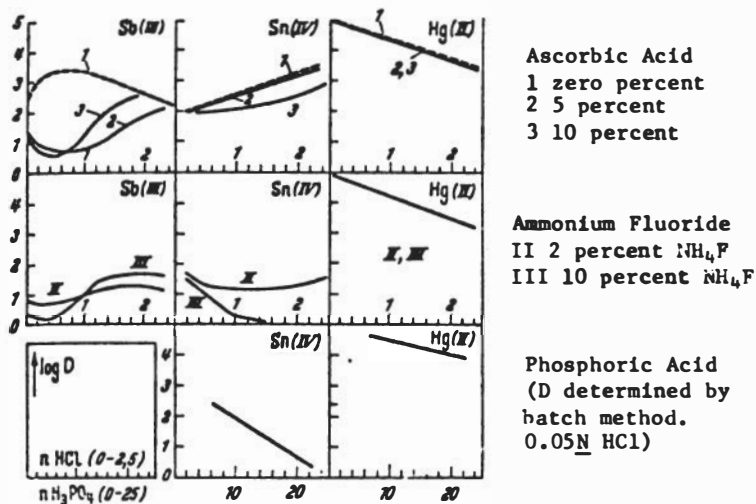

Figure 53. Dependence of distribution coefficients on acid molarity.

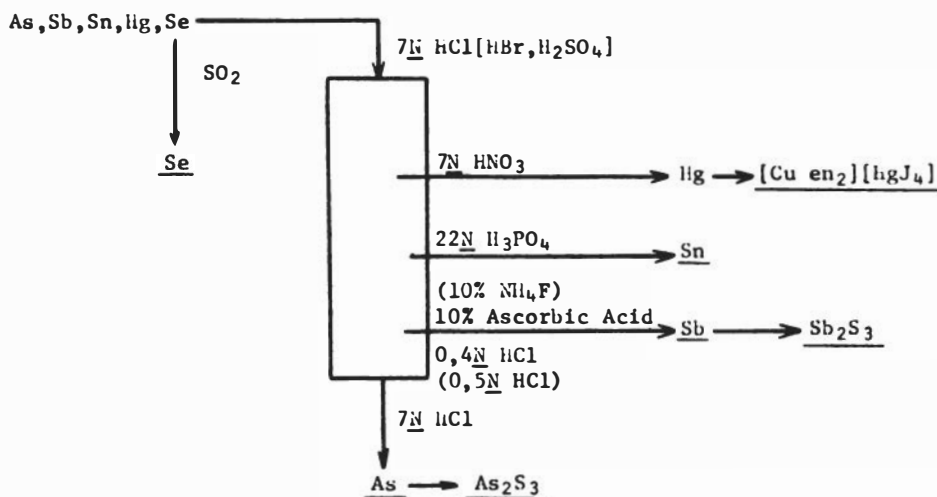

Figure 54. Flowchart for the separation of As, Sb, Sn, lig and Se.

copper was chosen, since the bismuth matrix may contain impurities which are more electro-negative than copper. With the latter, only the more electro-positive elements can be deposited, such as mercury, silver, gold, platinum, etc.

The deposition can be performed in hydrochloric<sup>217</sup> or nitric acid solution,<sup>218,219</sup> the latter being preferable as the former is rather time-consuming for a complete deposition. With nitric acid, good results are

obtained in the concentration range of 0.01-1.5 N. An acid concentration lower than 1 N favors the deposition of undesirable elements such as antimony and bismuth itself, whereas a concentration higher than 1.5 N causes a quick dissolution of the copper. Therefore the use of 1.0-1.5 N nitric acid is believed to be appropriate.

Preference was given to copper powder (200 mesh) over metal foils as the surface is larger. The copper powder was placed on a microfiltering unit, and the sample solution sucked through the copper powder at a rate of 2-3 ml/min. It was found that one passage gave a complete deposition of up to 100 mg of mercury on 1 gram of copper. This procedure was still insufficiently selective for the separation of mercury from other interfering species as gold, silver, etc. The obtained metallic mercury was therefore further purified by distillation, the distillate being collected on a silver foil.

#### Distillation

For the recovery of mercury, amalgamation with gold or silver foil is often used in conventional analytical procedures.

Accordingly, after the previous separation technique, the copper powder was transferred to a nickel crucible, inserted in the circular opening of an iron plate placed on an asbestos board, just large enough for the crucible to fit snugly and protrude by about half its height. This prevented the flame from heating the upper portion. The disc of the silver foil was cooled by contact with a cylindrical brass condenser, through which cold water circulated, as shown in Figure 55. The bottom of the crucible was

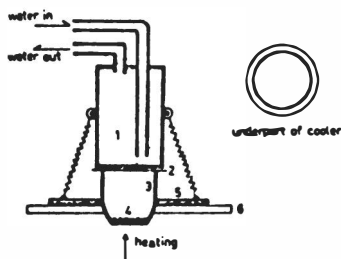

Figure 55. Apparatus for Hg distillation. 1, cooler: made of brass (o.d. ~3 cm, o.h. ~5 cm); 2, Ag plate (thickness ~0.05 mm, diam. ~3 cm); 3, nickel crucible (i.d. ~2.7 cm, height ~2.5 cm); 4, sample deposited on copper powder (Cu ~1g); 5, iron crucible-supporter; 6, asbestos.

gradually heated with a small bunsen burner, being careful not to overheat. To avoid the escape of mercury vapor, which might be due to overheating as well as to leakage between the silver foil and the crucible, a circular incision was made on the bottom surface of the condenser, to the edge of which the crucible could be matched, thus making a tight joint. All portions of the crucible were readily brought above the boiling point of mercury ( $375^{\circ}$ ) while the silver foil was kept at  $10-50^{\circ}$ . Heating for 30 minutes was sufficient to distill all the mercury deposited on the copper powder. The apparatus was then allowed to cool for 10 minutes without disconnecting the condenser. The increase in weight of the foil was due to mercury.

Before starting this procedure, the sample containing the mercury deposited on the copper grains should be washed with alcohol and ether, otherwise the moisture in the copper grains will condense on the foil and cause a poor amalgamation.

The results of this procedure were found to be satisfactory in accuracy and reliability. Gold and silver, deposited together with mercury on the copper grains, did not interfere.

## Experimental

### Sampling and Irradiation

Approximately 1 gram samples of high purity bismuth were taken from 3 different kinds of matrices: certified purity of 99.999 percent (B-1) of unknown but high purity (B-2) and of certified purity of 99.999 percent (B-3). The samples were washed with dilute nitric acid and packed in sealed quartz ampoules. The insides of the quartz ampoules were also thoroughly washed with concentrated nitric acid, water and alcohol, then dried, as they might contain mercury impurities.<sup>213</sup> The mercury contained in the quartz would not be removed by this procedure; the washing of the inner surface was only intended to avoid any accidental contamination.

For the standard, high purity mercuric oxide was used, dissolved in 6N nitric acid and diluted to a 10  $\mu\text{g/ml}$ ; 100  $\mu\text{l}$  were taken and sealed in a quartz ampoule.

The samples were irradiated for 3 days in the BR-1 reactor at a flux of  $4.10^{11}$   $\text{n/cm}^2/\text{sec}$ . The quartz ampoules were placed in liquid air before opening to condense any mercury vapor that might be formed during irradiation.

### Radiochemical Separation

Place the irradiated sample in a 150-ml beaker together with the open quartz ampoule. Add 18.5 mg of mercury carrier (18.5 mg/ml) and 5 ml of 7N nitric acid. Cover with a watch glass and dissolve on a hot plate by gentle heating.

Dilute to 30 ml with cold water and transfer to the reducing apparatus, in which about 1 gram of copper powder is placed. Wash the beaker with 1.4 N nitric acid and add to the sample solution. Pass the solution at a rate of 2-3 ml/minute through the copper powder and repeat this step. Wash the copper powder under suction, with water, alcohol and ether and carefully transfer to a nickel crucible set in the distillation apparatus. Insert a silver foil between the nickel crucible and the brass condenser, adjust the crucible and condenser together in the circular incision on the bottom surface of the condenser, and tighten with spring holders. Apply increasing heat to the bottom of the crucible during 30 minutes, taking care not to overheat. Allow to cool for 10 minutes without disconnecting the condenser.

Remove the silver foil, wash successively with alcohol and ether and dry in a desiccator. Weigh the foil and pack in a thin plastic bag for counting.

Standard samples are processed by the same technique.



## Counting

Counting was performed with a  $\gamma$ -scintillation spectrometer (3" x 3" NaI (Tl) crystal coupled to a 400-channel analyzer). For the quantitative measurements the photo peak in the 68-77 keV region was selected and counted for 5 minutes, starting 1.5 days after the end of the irradiation. When mounting the sample on the scintillation detector, the silver foil, packed in the plastic bag, was placed flatly, the amalgamated side toward the detector. It is obvious that this way of mounting gave rise to a somewhat better counting efficiency, since the silver foil absorbed the weak-energy  $\gamma$ -rays, i.e.  $\pm$  15 percent of the 68-77 keV region by 0.05 mm silver foil.

All the samples and standards were counted alternately and results were calculated by comparison of the obtained data.

## PROCEDURE 32.

Separation of Small Quantities of Mercury from Gross Amounts of Silver in Nitric Acid Solution by Displacement

Source: B. M. Maude and K. L. Wilkinson, Atomic Energy Research Establishment Report AERE-M 2008 (1968).

### 1. Introduction

Stable mercury isotopes as produced by the electro-magnetic separator, are collected in silver pockets. These pockets are then leached with strong nitric acid to give a solution containing mg quantities of the mercury isotope together with several gms of silver.

A chemical process was required which would quantitatively separate and recover this mercury, the final product to be in the form of mercury metal, or mercuric nitrate solution.

### 2. Procedure

Pure copper turnings were added to nitric acid solutions, of varying concentrations, containing the silver and mercury mixture until no further

reaction occurred, and subsequent additions of copper remained bright. The treated solution was filtered through a glass sinter, and the spongy Cu/Ag/Hg alloy washed thoroughly with water, and then with acetone before sucking dry. The dried alloy was loaded into a quartz tube which was sealed to a glass trap and vacuum line via a quartz/pyrex graded seal as shown in Figure 56.

The apparatus was evacuated, liquid nitrogen placed around the glass trap, and when the pressure was down to <1 torr the system was isolated

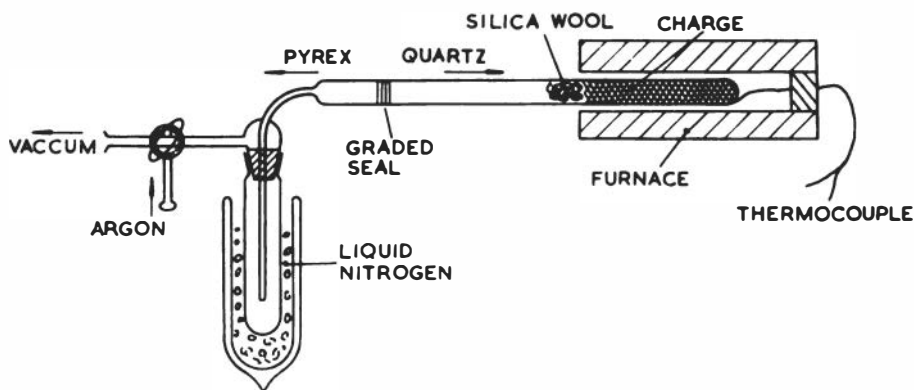

Figure 56. Apparatus for heating the Hg/Ag/Cu alloy.

from the vacuum pump. The charge was then heated, the temperature being raised to 700 °C over a period of several hours. Mercury was sublimed in the reaction tube just outside the hot zone of the furnace, and was flamed along the tube into the cold trap. When no more mercury was seen to sublime, the furnace was removed, the reaction tube allowed to cool, and the apparatus slowly let down to atmospheric pressure with argon, with the liquid nitrogen trap still in place. As soon as the system reached atmospheric pressure, the liquid nitrogen was removed, and the cold trap allowed to warm up to room temperature, the apparatus being open to the atmosphere during this last operation via the vacuum tap. The whole trap assembly was then broken from the quartz tube and the mercury content determined.

In the natural mercury trials, the collected mercury was dissolved in nitric acid and estimated as mercuric zinc thiocyanate. In the isotopic mercury runs, the mercury was carefully washed into a weighing bottle. After

rinsing well, the bulk of the wash water was removed by suction, and the final drying done in a  $P_2O_5$  desiccator. After weighing to constant weight, the isotopic mercury bead was kept under distilled water.

This method was found to give a good separation and a good yield. After several successful experiments with natural mercury it was used for the isotopic mercury processing.

The following points are very important when carrying out this method:-

- (a) Thorough washing of the Hg/Ag/Cu alloy until free from nitrate ions.
- (b) Making sure the alloy is dry before loading.
- (c) Heating the charge for a sufficient length of time.
- (d) Heating the charge to a sufficiently high temperature. Most of the mercury is released below  $500^\circ C$ , but some heating is required at  $700^\circ C$  to remove the last traces.
- (e) Leaving the liquid  $N_2$  trap in place when letting the apparatus down to atmospheric pressure.

Failure to observe any one of these conditions was found to give low yields.

### PROCEDURE 33.

#### Determination of Mercury Vapor in Air

Source: L. Magos, Brit. J. Industr. Med. 23, 230 (1966).

#### Materials and Methods

Mercuric acetate-potassium chloride reagent:  $2.5 \times 10^{-4}$  M mercuric acetate and 0.25 M potassium chloride in glass distilled water. Weaker solutions were prepared by dilution. The mercuric acetate was labelled with  $Hg^{203++}$  solution obtained from the Radiochemical Centre, Amersham. The increase in mercury concentration caused by labelling was always less than 1.0 percent.

### Determination of Mercury Concentration in the Solutions

Excess penicillamine (Koch-Light Labs Ltd.) was added to the samples, and the penicillamine not bound to mercury was determined with 5,5-dithio-bis-2 (2-nitrobenzoic acid).

### Radiochemical Measurements

0.5 to 2.0 ml of the solutions were counted in a well-shaped NaI scintillation detector (Detector N664B) with a scaler (N610A, Ekco Electronics, Ltd.), having a counting efficiency for  $\text{Hg}^{203}$  of 40 percent with a background of 600 counts/100 seconds. Specific activities were expressed as counts/100 second/ $\mu\text{g}$  Hg. The activity of mercury absorbed by the absorber was counted by inserting the absorber into the well of the NaI scintillation detector.

### Absorber

The absorbers were Polyallomer tubes  $5/8 \times 3$  inches (15.8 x 76.2 mm) (Beckman Instruments, Inc., Spinco Division) containing activated hopcalite (Hopkins and Williams Ltd., a solid mixture of copper and manganese oxide.) Inlet and outlet tubes were sterivac polythene cannulae, size 4, bore 2.0 mm,

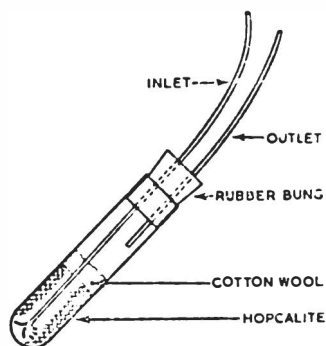

Figure 57. The absorber.

wall thickness 0.5 mm (Allen & Hanbury's, Ltd.), led through a rubber bung with a close but a sliding fit. The inlet touched the bottom of the tube and its end was cut and splayed (Figure 57). The absorber was filled by

holding the splayed end of the inlet cannula firmly to the bottom of the tube; introducing 3 g hopcalite; covering with cotton wool; and stoppering the tube by sliding the bung down the inlet cannula.

#### Saturation of Air with Mercury

The saturation system is shown in Figure 58. Compressed air was passed through a Flostat minor (G. A. Platon Ltd.) to regulate the air flow; a Rotameter (Rotameter Manufacturing Co.) of 5-150 ml/min capacity to measure the air flow and five 50 ml and one 250 ml. Quickfit wash bottles, their bottoms covered with metallic mercury; and a coil condenser with 14 coils, every coil containing one droplet of mercury.

In the majority of the experiments saturation was carried out at room temperature. In some experiments air was saturated with mercury at room temperature in the wash bottles and subsequently desaturated at 0 °C. The coil condenser and a 250 ml gas washing bottle filled with glass wool were connected in series and immersed in ice. The outgoing air was passed through an inverted Quickfit stirrer guide containing a thermometer which was supported by a pad of glass wool and stoppered. (These modifications are not shown in Figure 58.)

At 0 °C the saturated air was assumed to contain 2.24 µg Hg per liter, the concentration used by Thorpe and Marriott (1957) for calibrating ultra-violet mercury vapor meters. At room temperature mercury concentrations were calculated from the simplified equation:

$$\mu\text{g Hg/liter} = \frac{200.6 \times (\text{v.p.}) \times 10^6}{760 \times (\text{mol. vol.})} \quad (1)$$

where 200.61 is the atom weight of mercury; v.p. is the vapor pressure of mercury given by the Handbook of Chemistry and Physics (1951) and mol. vol. is the molar volume of mercury at saturation temperature. Changes in atmospheric pressure influence mercury concentration insignificantly so the mole volume was not corrected for them.

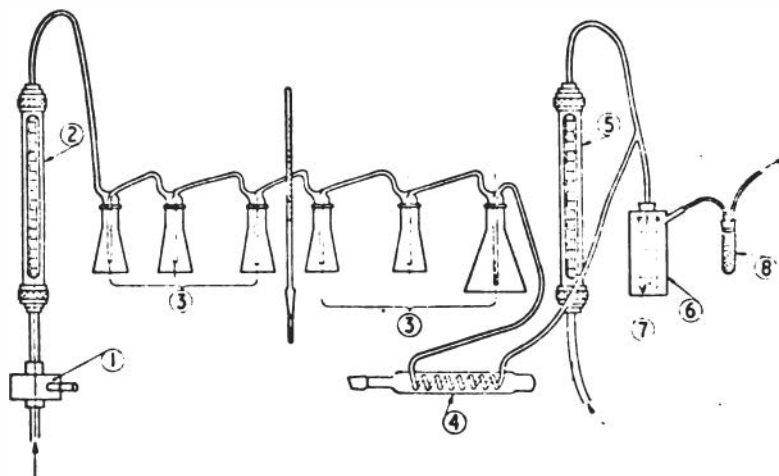

Figure 58. Details of the system for producing and sampling known concentrations of mercury vapor. (1) Flostat minor to regulate the air flow through the saturation system; (2) rotameter to measure the volume of the saturated air; (3) Quickfit wash bottles having mercury layer in the bottom; (4) coil condenser having mercury droplets in the coils; (5) rotameter to measure the volume of mercury-free air; (6) lead shield; (7) midget impinger; (8) absorber.

To obtain lower concentrations the saturated air was mixed with a mercury-free air by a Y piece. Mercury-free air was taken from the laboratory atmosphere by filtering it through hopcalite attached to the inlet of a rotameter of 0.5-5.0 liters/minute capacity and its flow rate was regulated with a Flostat.

#### Method of Operation

The air, with or without added mercury, was sucked through a 30 ml impinger containing 20 ml of reagent and then through one or more absorbers. The flow rate was 1 liter/minute except when stated otherwise.

#### 1 $\mu$ g Calibration

A plastic syringe with a horizontal tube connected to its eccentric orifice was used for 1  $\mu$ g of calibration (see Figure 59). The syringe consists of an outer cylinder, an inner cylinder, and a piston. The inner cylinder can be rotated in the outer cylinder. When the orifices of the inner

and outer cylinders communicate, the piston provides the means of adjusting the chamber volume and of filling or emptying the chamber. The volume of the inner cylinder is graduated in  $^{\circ}\text{C}$  in such a way that when it is filled with mercury-saturated air to the mark of the room temperature it contains  $1\ \mu\text{g}$  mercury vapor. The syringe was made airtight with silicon stopcock grease (Edward High Vacuum, Ltd.). To fill the syringe the horizontal tube was connected with the saturating system and with a water pump giving 75 to 100 ml/minute air flow. After two to three minutes' flow to ensure saturation in the tube the piston was slowly pulled to the correct mark. The syringe was then closed by turning the inner cylinder. The horizontal tube was disconnected from the saturating system and 0.5 minutes later from the water pump. It was connected with the inlet of the midget impinger without interrupting the 1 liter/minute air flow. The syringe was opened by turning back the inner cylinder to the original position and the piston was pushed in.

The syringe provided a way of introducing a small quantity of mercury vapor into the air stream in a high reproducible way without the errors which may attend mixing two air streams. It was therefore useful for standardizing the apparatus and for investigating those factors upon which the exchange reaction depended.

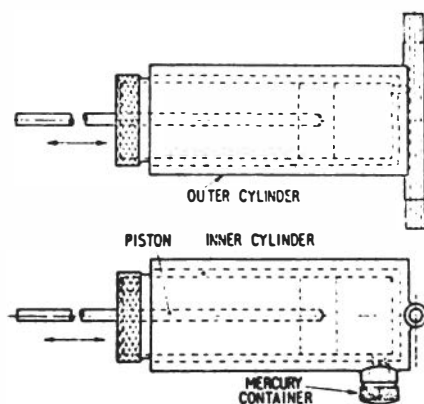

Figure 59. Plane (upper sketch) and side view (lower sketch) of the  $1.0\ \mu\text{g}$  calibrator.

The syringe was also designed so that the mercury-saturated air could be produced within it without the use of an external saturating system. The lower part of the syringe (Figure 59) has a removable attached container which can be filled with mercury, and the inner cylinder has an aperture which can be lined up with this so that the air in the syringe can become saturated. In 40 to 45 minutes 98 to 99 percent saturation was achieved. Before injecting the saturated air the mercury container was always replaced by a solid stopper to avoid the risk of mercury vapor escaping from the container through the grease into the air stream due to the negative pressure.

#### Disposal of Radioactive Waste

The reagents usually contained less than 2  $\mu\text{c}/20$  ml. This low radioactivity may be disposed of as normal laboratory waste down a sink. The hopcalite contains much less  $\text{Hg}^{203}$  than the reagent and can be disposed of as normal solid waste.

#### PROCEDURE 34.

##### Mercury Analysis by Isotopic Dilution

Source: J. Ruzicka and J. Stary, *Talanta* **8**, 535 (1961).

This method permits the determination of mercury in amounts of  $10^{-6}$  to  $10^{-7}$  g/ml with an average precision of  $\pm 0.5$  percent and in amounts of  $10^{-8}$  to  $10^{-9}$  g/ml with an average precision of  $\pm 2.5$  percent.

#### Apparatus required:

Scintillation counter with a well-type NaI (Tl) detector,

Mechanical shaker, and

Glass test tubes, 25 ml volume, with ground stoppers.



Chemicals:

Water, redistilled,

Carbon Tetrachloride, analytical grade,

Dithizone, analytical grade,

Sulfuric acid, analytical grade, 50 percent and 5 percent solutions,  
purified by extraction with a  $\text{CCl}_4$ -dithizone solution.

Radiomercury solution (46.9-day  $\text{Hg}^{203}$ ). A solution of a specific activity of 30 mC/g was diluted to an appropriate concentration with 5 percent sulfuric acid.

Procedure

To 10 ml of the solution of non-active mercury ( $10^{-6}$  to  $10^{-7}$  g/ml) which may contain a large excess of other metals, an amount of the same order of magnitude of radiomercury is added. To this solution 4 ml of 50 percent  $\text{H}_2\text{SO}_4$  and 1 ml of 10 percent  $\text{NH}_2\text{OH}\cdot\text{HCl}$  are added to reduce oxidizing agents, which may be present, and which would decompose dithizone. The solution thus prepared is extracted by 1.5 ml of  $2 \times 10^{-5}$  M dithizone solution in  $\text{CCl}_4$ . After shaking for 10-20 minutes which is sufficient to reach equilibrium, the organic phase is separated, and the activity  $A_2$  of 1.00 ml of the extract is measured with a scintillation counter. At the same time, a solution which contains only radiomercury, 4 ml of 50 percent  $\text{H}_2\text{SO}_4$  solution, 1 ml of a 10 percent  $\text{NH}_2\text{OH}\cdot\text{HCl}$  solution, and about 1.5 ml of the dithizone solution, is extracted. The activity of 1.00 ml of this extract,  $A_1$  is measured in the same way.

The amount of non-active mercury is determined from the relation:

$$x = y \left[ \frac{A_1}{A_2} - 1 \right]$$

In determining smaller amounts of mercury the same procedure is followed, again adding amounts of radiomercury of the same order of magnitude and less dithizone than corresponds to the amount of mercury present. The most satisfactory ratio of active and non-active mercury is 1:1. Because

a more dilute solution of dithizone is used, the solution to be analyzed should be less acid; therefore a smaller amount of sulfuric acid (4 ml of 4 percent H<sub>2</sub>SO<sub>4</sub> solution) is used.

#### PROCEDURE 35.

##### Radiometric Determination of Submicrogram Amounts of Mercury

Source: J. Stary and R. Milosevic, *Talanta* 14, 521 (1967).

The radiometric method for the determination of mercury by exchange with silver-110m dithizonate given below permits the determination of as little as  $5 \times 10^{-10}$  grams of mercury/ml. Gold is the only element interfering seriously.

Exchange reactions between a metal to be determined and a complex of another metal with lower stability or extraction constant are often used in analytical chemistry. With the use of radioisotopes the sensitivity of determinations of this type can be greatly increased. From the extraction constants of the metal dithizonates<sup>220,221</sup> it follows that silver is completely exchanged by mercury according to the equilibrium:

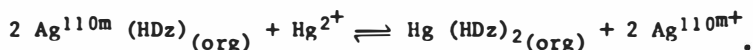

Preliminary experiments showed that equilibrium for this reaction is reached within 1 minute. The amount of mercury present can be found from the decrease in the radioactivity of the silver-110m dithizonate in the organic phase or from the increase in the radioactivity of the silver-110m cations in the aqueous phase.

##### General Procedure

To 8 ml of the test solution (pH 1-2) containing 0.01-0.10  $\mu\text{g}$  of mercury, and 1 ml of 5 percent urea solution and 1 ml of 10M acetic acid (previously purified by dithizone extraction). Transfer the solution into a separate funnel, and add 1.00 ml of  $10^{-6}$  M silver-110m dithizonate in carbon tetrachloride. The dithizonate solution is prepared by shaking  $10^{-6}$  M dithizone

solution in carbon tetrachloride with an excess of silver-110m nitrate solution containing 0.5 percent of urea and 1 N acetic acid. Thus prepared, and kept in the dark, the solution is stable for at least two days. Shake the funnel for 2-3 minutes, transfer 0.50 ml of the organic phase into an aluminum planchette, evaporate to dryness and measure the activity with a Geiger-Muller counter. A typical calibration curve is linear and has a slope of  $-1400 \text{ cpm silver activity}/10^{-8} \text{ g of mercury/ml}$ .

For determination of mercury in amounts ten times as great, use  $10^{-5} \text{ M}$  silver-110m dithizonate. The specific activity of silver-110m available permits the determination of mercury down to  $5 \times 10^{-10} \text{ g/ml}$  with sufficient precision. The method is rather selective; only palladium, gold, silver, and large amounts of copper and bismuth interfere, and these must be removed.

#### Procedure in the presence of palladium, copper and bismuth

To 8 ml of the test solution in 2N sulphuric acid, containing 0.1-1.0  $\mu\text{g}$  of mercury and 20 times as much palladium or 100 times as much copper and bismuth, add 1 ml of 0.01M 8-hydroxyquinoline solution in 10N acetic acid. Extract palladium (and partially copper and bismuth) as the 8-hydroxyquinolate several 5 ml portions of chloroform. To the aqueous phase, still containing all the mercury, add 1.00 ml of  $10^{-5} \text{ M}$  silver-110m dithizonate in carbon tetrachloride, and test the solution as previously described. The amount of mercury is found from the calibration curve.

#### Procedure in the presence of silver

To 8 ml of the test solution (pH 1-3) containing 10-100 times as much silver as mercury, add 1 ml of 5 percent urea solution, 1 ml of 10 N acetic acid and 1.3 g of solid sodium chloride so that the total concentration of chloride ions is now about 12.5 percent). Extract the mercury quantitatively with an excess of dithizone solution in carbon tetrachloride (for 0.1-1.0  $\mu\text{g}$  of mercury use 2.00 ml of  $10^{-5} \text{ M}$  dithizone solution), leaving the silver completely in the aqueous phase. Transfer 1.00 ml of the organic extract into another separating funnel, and shake it for 2 minutes with an excess of silver-110m nitrate solution containing 0.5 percent of urea and 1 M acetic

acid. Transfer 0.50 ml of the organic extract to a planchette, evaporate it to dryness and measure the activity with a Geiger-Müller counter. The amount of mercury in the test sample is determined from a calibration curve prepared under the same conditions as before.

#### PROCEDURE 36.

##### Simple and Rapid Determination of Mercury in Urine and Tissues by Isotope Exchange

Source: T. W. Clarkson and M. R. Greenwood, *Talanta* 15, 547 (1968).

##### Principle of Method

Current methods for the determination of mercury in urine and other biological materials require that the organic material should be removed by chemical oxidation, either partially or completely. As has been stressed by others,<sup>222,223</sup> the chief problem lies in the digestion procedure. Too vigorous oxidation results in losses of mercury by volatilization, too little leads to incomplete extraction by the complexing agents (e.g., dithione). If the chemical oxidant is not completely reduced after the digestion procedure other complications result.

The method described here avoids these difficulties by making use of an entirely new procedure. Sufficient quantities of cysteine are added to the biological sample to complex all the mercury present. Trace quantities of radioactive mercury,  $\text{Hg}^{203}$ , are added, which rapidly equilibrate with the non-active mercury in the cysteine complex. The biological sample, now containing labelled mercury complexed to cysteine, is exposed to non-radioactive mercury vapor. A rapid isotopic exchange takes place resulting in the transfer of radioactivity to the vapor phase. Experimental conditions are adjusted to that the half-time of the exchange process is directly proportional to the concentration of mercury in the sample.

ExperimentalReagents

Cysteine hydrochloride. Sodium hydroxide, 1.0M. Sodium chloride, 0.9 percent solution. Octyl alcohol.  $\text{Hg}^{203}$  isotope as mercuric nitrate at a specific activity of approximately 1 mc/mg (Cambridge Nuclear Co., Cambridge, Mass.).

Apparatus

The general arrangement of the apparatus is shown schematically in Figure 60.

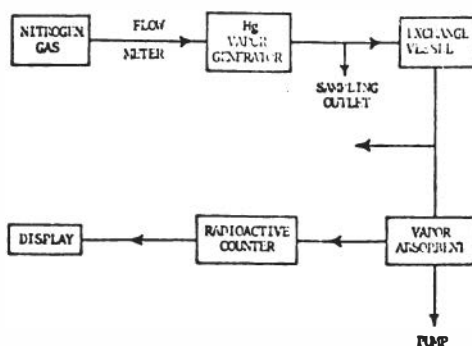

Figure 60. Schematic arrangement of apparatus.

Mercury vapor was generated by passing nitrogen at a flow-rate of 240 ml/min through a midget impinger (Gelman Instrument Co., Ann Arbor, Michigan Model No. 7202) containing a small quantity of metallic mercury. The impinger was immersed in water at 45 °C. The vapor was passed through a second impinger containing a similar amount of metallic mercury but maintained at room temperature. The nitrogen gas emerging from the second impinger contained almost the saturation level of mercury (20 mg/m<sup>3</sup>). The vapor then passed to the exchange vessel where it bubbled through the aqueous phase containing the radioactive mercury. The vessel, shown in Figure 61, consisted of a vertical pyrex glass tube, length 52.5 cm, internal diameter 1.9 cm, stoppered at each end by rubber bungs and had a nylon inlet-tube (Labtician Products, Hollis, New York, 0.096 in. bore, 0.125 in. outside diameter) extending to the bottom, the lower end of the

nylon tube being heat-sealed and perforated with small holes. A short nylon outlet-tube passed through the upper rubber stopper. The issuing vapor was passed through a watertrap consisting of a small disposable plastic test-tube, 12 x 75 mm (Falcon Plastics, California) and then through a similar tube containing about a 1-inch length of activated Hopcalite. The Hopcalite tube was placed in a NaI well-crystal to record  $\text{Hg}^{203}$  activity. The counting equipment consisted of a decade counter (Radiation Instrument Detection Laboratories, Des Plaines, Ill., Model No. 49-51), a rate-meter (Packard Inst., Co., La Grange, Ill., Model No. 280 A) and a pen-recorder (Leeds Northrup, Philadelphia, Pa. Type G.).

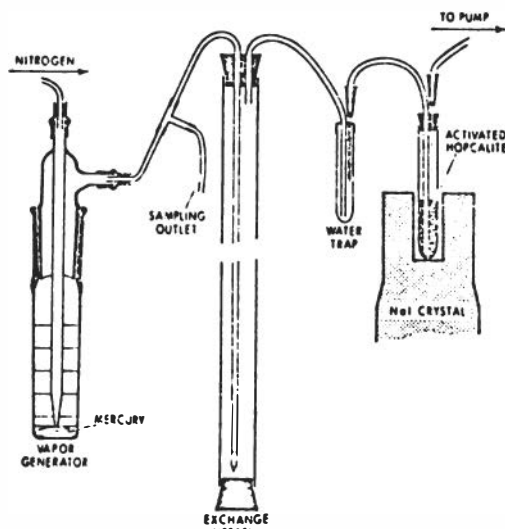

Figure 61. The exchange and counting assembly.

Nitrogen gas was drawn through the system by a small electric pump (Universal Electric Co., Owosso, Michigan, Model No. 3) and the flow-rate recorded by a flow-meter (Brock Inst. Co., Hatfield, Pa.).

### Procedure

Pour 70 ml of urine into a 100-ml graduated cylinder containing 3.15 gram of cysteine hydrochloric and 22.5 ml of 1.0M sodium hydroxide. Add a trace quantity of  $\text{Hg}^{203}$  isotope to give at least 10,000 cpm and a final mercury concentration of  $10^{-8}$  M. Dilute to the 100-ml mark with 0.9

percent sodium chloride solution and add 1 ml of octyl alcohol to prevent foaming. Mix the contents of the cylinder and pour them directly into the exchange vessel. Start the nitrogen flow (containing mercury vapor at  $17 \text{ mg/m}^3$ ) at a rate of  $240 \text{ ml/min}$ . Record the radioactivity in the Hopcalite absorbent as a function of time and stop the exchange run when the activity in the Hopcalite has become steady. At this point all the radioactivity in the exchange vessel is completely transferred to the Hopcalite, so the final trace on the recorder represents the initial radioactivity in the urine, and the difference between the final pen-recording and the pen-recording at any given time during the exchange run is the amount of activity remaining in the urine. This value is plotted on semi-log paper (Figure 62) against time and yields a straight line from which the half-time can be calculated. The amount of mercury originally present in the urine sample is calculated from the half-time by referring to the standard curve.

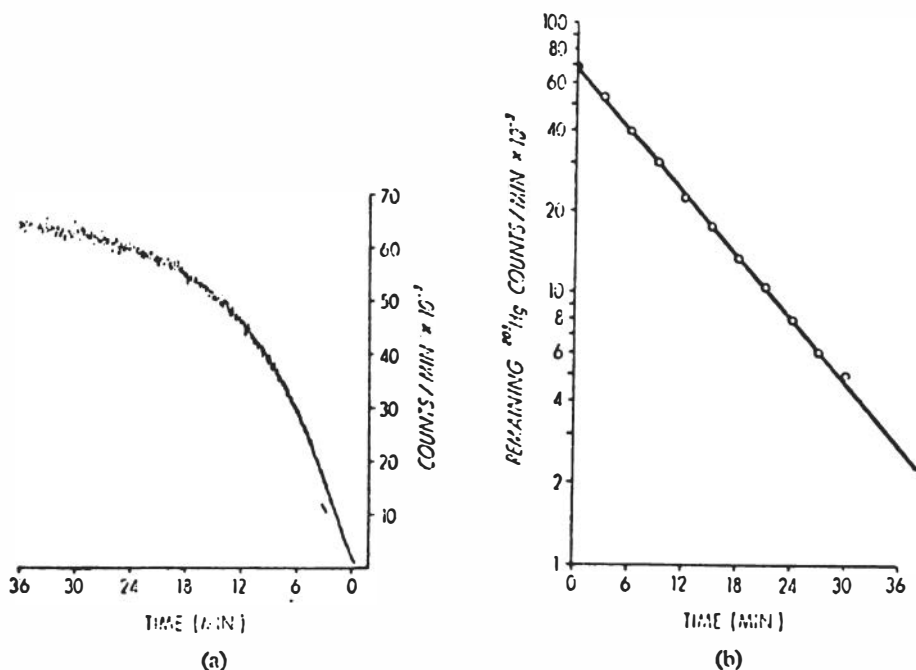

Figure 62. (a) Recorder tracing. (b) Semi-log plot. The radioactivity remaining in the solution at any time was calculated from the pen-recording as described in the text.

To measure the mercury in kidney or liver, 1 gram wet-weight of tissue is chopped and homogenized in 0.9 percent sodium chloride solution with a tissue grinder, made up to a volume of 70 ml with 0.9 percent sodium chloride solution, and then treated identically to the urine sample.

A standard curve is prepared by applying above procedure to 0.9 percent sodium chloride solutions containing known amounts of mercuric chloride in the concentration range  $10^{-7}$  to  $3 \times 10^{-6}$  M and plotting  $t_{1/2}$  against the concentration of mercury added.

## Discussion

### Flow of mercury vapor and carrier gas

As indicated by theory and confirmed by experiment, the exchange half-time is inversely proportional to the vapor flow-rate. This fact allows the exchange half-time to be set for any given value of the mercury concentration. When dealing with low concentrations of mercury, it is convenient to reduce the mercury vapor concentration so that the half-time falls within the response time of the recording equipment and yet is not too large to make the measurement very time-consuming.

Nitrogen was used as the carrier gas in order to remove oxygen from the system. There were three reasons for this: to prevent formation of any oxide layer over the metallic mercury in the vapor generator; to prevent any oxidation of cysteine in the exchange vessel; to avoid any conversion of mercury vapor into mercury(II) ions in the aqueous phase, which is known to require oxygen.<sup>224</sup>

In the principle it is best to make the flow of nitrogen as rapid as possible so that the transit time of mercury in the plastic tubing is brief. In practice the flow is limited by the rate at which bubbles will pass through the exchanger without spillage or excessive foaming. A flow of 240 ml/min is close to the practical maximum and this requires the use of an antifoaming agent when biological samples are being analyzed.



Cysteine, 0.2M, pH 7.4

In order to measure non-radioactive mercury present in biological samples two conditions had to be met: first, that the non-radioactive mercury would immediately equilibrate with trace quantities of  $\text{Hg}^{203}$  isotope added to the sample, and second that the total mercury in the labelled sample should be converted into one chemical species capable of undergoing rapid isotope exchange with mercury vapor. The use of the monothiol compound cysteine achieved both conditions. This compound was chosen because it had previously been shown that mercury complexed with cysteine underwent rapid isotopic exchange with mercury vapor<sup>225</sup> and that concentrations of monothiol compounds greater than  $10^{-2}$  M were capable of removing mercury from tissue homogenates;<sup>226</sup> other monothiol compounds may also be used, but cysteine is the cheapest and most readily available commercially.

The pH of 7.4 was used because the reaction is not sensitive to small fluctuations in pH in this region. The exchange rate is reduced in acidic solutions of cysteine, and, on the other hand, cysteine is readily oxidized at very high pH values.

Antifoaming agents

These are necessary to prevent excessive foaming when urine and tissue homogenates are present in the exchange vessel. However, octyl alcohol reduces the exchange rate. Complete isotopic exchange in the exchange vessel is indicated when the slope of the plot of  $t_{1/2}$  against  $[\text{Hg}]_{\text{aq}}$  agrees with the theoretical value. This occurs only with solutions of mercury in saline or cysteine buffer. In the presence of octyl alcohol, the slope is about 90 percent of the theoretical. However, this slope is the same and reproducible both with standard solutions and biological samples.

The construction of the exchange vessel

Complete isotopic equilibration between vapor and aqueous phases was achieved by adjusting two variables: the surface area of contact between the phases was made as large as possible by generating small bubbles,

and the aqueous phase was encased in a narrow vertical tube so that the time of rise of the bubbles from the bottom to the top of the sample was long.

#### The absorption of mercury vapor on hopcalite

This material was chosen because it is efficient, absorbent, cheap and commercially available. When hopcalite is present in the absorbent tube to a depth of 1 inch, all the radioactivity is collected in the lower 25 percent of the column. When a second hopcalite tube was placed in series with the first, no radioactivity was ever found in the second tube. An average of 98 percent of the radioactivity removed from the exchange vessel was recovered in the hopcalite. Small losses can occur if the plastic tubing leading from the exchange vessels is excessively long or if the flow-rate of carrier gas is very low.

#### Plastic tubing

Plastic tubes made from tygon, polyethylene and nylon have been found to be equally acceptable. The length of tubing was kept as short as possible to avoid potential loss of mercury by diffusion through the plastic or by adsorption on surfaces of the tubes.

#### Vacuum pump

The purpose of the pump was to maintain a slight (1-5 cm of water) negative pressure throughout the vessels and tubing so that, in the event of a leak, radioactive or stable mercury would not be released into the laboratory. A cheap electrically operated pump was used but a water pump is equally effective.

#### Radioactive detection and display equipment

The essential items are a NaI(Tl) gamma detector with a well large enough to accept the Hopcalite tube, a suitable tube and a suitable scaler to record the activity. The rate-meter and the recorder are a convenience in that they allow a graphic recording of the rate of build-up of radioactivity in the Hopcalite and can give accurate recording when the exchanger rate is rapid. However, a manual instrument can be used when 1-minute counts are made at appropriate intervals, but the half-time of exchange has

to be 5 minutes or more. If the very low concentrations are being measured the half-time can be adjusted by lowering the concentration of mercury vapor and/or the rate of flow of carrier gas.

#### Applications and limitations

The great advantage of this technique is that it is both rapid and simple. It avoids the tedious procedures involved in the removal of organic material from biological samples by oxidation, with all the attendant uncertainties. This method is ideal for checking urine or tissue samples to see whether higher-than-normal concentrations of mercury are present, and if there has been exposure to inorganic mercury (vapor or salt). However, mercury present in urine or tissue as an organic mercury compound with at least one covalent link with a carbon atom will not undergo rapid isotopic exchange, for example the mercurial diuretics.

The method has been tested for samples containing 2.0  $\mu\text{g}$  or more of mercury. The theoretical limit to the sensitivity of the method is determined by the specific activity of the  $\text{Hg}^{203}$  isotope. With the specific activity commercially available (5 mc/g) and very low concentrations of the vapor passed through the exchange vessel, the lower limit of detection should be approximately 0.025  $\mu\text{g}$  of mercury.

#### PROCEDURE 37.

##### Spectrophotometric Determination with Dithizone

This method is adapted from the method of S. S. Yamamura, *Anal. Chem.* 32, 1896 (1960).

Source: E. F. Norton, *Chemical Yield Determination in Radiochemistry* NAS-NS-3111 (1967).

##### Reagents:

HCl - 2F

NaCl - solid

KClO<sub>3</sub> - solid

NH<sub>4</sub>OH - concentrated.

**EDTA:** ammonium chloroacetate buffer - 0.002F EDTA:0.1F

ammonium chloroacetate. Dissolve 4.7 g of chloroacetic acid in about 400 ml of water and adjust the pH to 2.7 with concentrated  $\text{NH}_4\text{OH}$ . Add 0.37 g of disodium ethylenediamine tetraacetate and stir for several hours. Filter, if solution of the EDTA is incomplete, and dilute to 500 ml.

Dithizone - about 10 micrograms per ml in  $\text{CHCl}_3$ . Prepare a solution containing about 0.5 mg of dithizone per ml in  $\text{CHCl}_3$ . This solution is stable for at least a month if kept in the refrigerator. Dilute the concentrated solution before use to give a solution containing 10 to 12 micrograms of dithizone per ml in  $\text{CHCl}_3$ .

**Procedure:**

- 1) Mercury is generally counted as  $\text{HgS}$  or as  $\text{Hg}_2\text{Cl}_2$ . Transfer the sample to a 50 ml beaker. Add 10 ml of 2F  $\text{HCl}$  and a few crystals of  $\text{KClO}_3$ . Warm to dissolve the sample. Boil until all the  $\text{Cl}_2$  is expelled. Dilute to volume with water.
- 2) Into a 50 ml beaker take an aliquot containing less than 20 micrograms of  $\text{Hg(II)}$ . If the sample is an acid solution of  $\text{Hg(II)}$  which contains no chloride, add about 10 mg of  $\text{NaCl}$ . Adjust the pH to about 3 with  $\text{NH}_4\text{OH}$ , using a pH meter. Transfer the solution to a stoppered centrifuge tube.
- 3) Add 5 ml of EDTA: ammonium chloroacetate buffer. Dilute to 20 ml with water.
- 4) Add 5.0 ml of dithizone solution (10 to 12 micrograms per ml).
- 5) Stopper and shake for 15 seconds.
- 6) Centrifuge. Withdraw and discard the aqueous phase using a capillary and suction.
- 7) Measure the absorbance of the  $\text{CHCl}_3$  phase at 510  $\mu$  in a 1 cm stoppered cell. Subtract a blank which has been carried through the procedure from step 3. Prepare a calibration by taking known amounts of  $\text{Hg(II)}$

through the procedure from step 2. The calibration should be checked for each new dilution of dithizone solution.

Interferences: See Sandell<sup>212</sup> pp. 158-163.

Other methods:

Mercury can be determined polarographically by measuring the diffusion current at a constant potential (-0.1 volts vs. the saturated calomel electrode) of Hg(II) in 1F HCl containing 0.005 percent gelatin.

Mercury can also be determined by atomic absorption.

VII. BIBLIOGRAPHY

1. Lederer, Hollander, and Perlman, Table of Isotopes, (John Wiley, New York, N. Y., 1967), 6th ed.
2. N. E. Holden and F. W. Walker, General Electric Company Chart of the Nuclides, revised July 1969.
3. C. L. Gordon and E. Wichers, Ann. N. Y. Acad. Sci. 65, 369 (1957).
4. Forsling, Hietanen, and Sillen, Acta Chim. Scand. 6, 901 (1952).
5. W. D. Latimer, The Oxidation States of the Elements and Their Potentials in Aqueous Solution (Prentice Hall, Inc., New York, 1938).
6. C. V. King, Ann. N. Y. Acad. Sci. 65, 360 (1957).
7. W. W. Meinke, Chemical Procedures Used in Bombardment Work at Berkeley, U. S. Atomic Energy Commission Report AECD-2738 (1949), p. 232.
8. R. S. Maddock and W. W. Meinke, Progress Report No. 8, University of Michigan, 1959, pp. 46-53.
9. DeVoe, Nass, and Meinke, Anal. Chem. 33, 1713 (1961).
10. B. H. Morrison, and R. E. Blanco, The Hermex Process for Metal Decontamination by Hg-Processing, Oak Ridge Central Files Report ORCF-56-1-151 (1956).
11. Leary et al., Pyrometallurgical Purification of Pu Reactor Fuels, Proceedings of the International Conf. on the Peaceful Uses of Atomic Energy, Geneva, Vol. 17, 376 (1958).
12. S. S. Choi and D. G. Tuck, J. Chem. Soc. 1962, 4080-4088.
13. J. W. Pfennington, Bureau of Mines Information Circular 7941 (1959).
14. J. Soucek, Chem. Listy 58 (10), 2003 (1964).
15. E. Krause and A. von Grosse, Metall-Organische Verbindungen (Verlag Bornträger, Berlin, 1937), pp. 127-90.

16. H. T. S. Britton, Hydrogen Ions (D. Van Nostrand Co., New York, 1943), Vol. 2.
17. A. A. Noyes and W. C. Bray, A System of Qualitative Analysis for the Rare Elements (The MacMillan Co., New York, 1943).
18. G. Jander and H. Wendt, Lehrbuch für das anorganisch-chemische Praktikum (S. Hirzel, Leipzig, 1948).
19. T. Yamane and N. Davidson, J. Am. Chem. Soc. 81, 4438 (1959).
20. N. I. Sax, Handbook of Dangerous Materials (Reinhold Publishing Corp., New York, 1951), pp. 236-7.
21. H. E. Voress and N. K. Smelcer, Mercury Toxicity. A Bibliography of Published Literature, U. S. Atomic Energy Commission Report TID-3067 (1957).
22. R. O. R. Brooks and A. Holmes, The Control of Mercury Metal in the Laboratory, Atomic Energy Research Establishment Report, AERE-Med/R-2350 (1966).
23. Stock et al., Z. Angew. Chem. 44, 200 (1931), and Z. Angew. Chem. 46, 62 (1933).
24. F. J. Welcher, Organic Analytical Reagents (Van Nostrand, New York, 1947).
25. J. F. Coetzee in I. M. Kolthoff and P. J. Elving, Treatise on Analytical Chemistry (Interscience Publishers, New York, 1961), Part II, Vol. 3, Section A, pp. 231-326.
26. E. D. Fultz, Thermodynamic Stability Constants of Organic/Metal-Ion Complexes, University of California Radiation Laboratory Report UCRL-50200 (1967).
27. A. C. Wahl and N. A. Bonner, Radioactivity Applied to Chemistry (Wiley, New York, 1951).
28. K. Bielfeldt and A. Gänssle, Angew. Chem. 66, 563 (1954).
29. W. L. C. vanZwet and J. C. Duran, Chem. Weekblad 38, 186 (1941).
30. T. S. West, Anal. Chim. Acta 25, 405 (1961).
31. A. E. Ballard and C. D. W. Thornton, Ind. Eng. Chem. Anal. Ed. 13, 893 (1941).
32. R. Vesterberg and O. Sjöblom, Arkiv Kemi Mineral. Geol. 22, No. 22 (1946).
33. H. O. Phillips and K. A. Kraus, J. Am. Chem. Soc. 85, 486 (1963).
34. I. M. Korenman and M. N. Baryshnikova, Zhur. Anal. Khim 12, 690 (1957).
35. V. T. Chuiko and A. U. Mamenko, Zhur. Anal. Khim. 11, 332 (1956).
36. Korenman et al., Zhur. Neorg. Khim. 1, 863 (1956).
37. V. Prochazkova and V. Jara, Z. Anal. Chem. 161, 251 (1958).
38. V. I. Kuznetsov and G. V. Myasoedova, Referat. Zhur. Khim., (1956) Abstr. No. 10,085.

39. E. L. King, *J. Am. Chem. Soc.* 71, 3553 (1949).
40. Reuben, Seaborg, and Kennedy, *J. Appl. Phys.* 12, 308 (1941).
41. J. M. Cross and J. J. Pinajian, Observations on the Exchange of Mercury Between Phenylmercuric Chloride and Mercuric Chloride Using Mercury 203, U. S. Atomic Energy Commission Report AECU-863 (1950).
42. Reutov, Smolina, and Khum-Ven Khu, *Izvest. Akad. Nauk SSSR, Otdel Khim. Nauk* 1959, 559-60.
43. Nefedov, Sinotova, and Frolov, *Zhur. Fiz. Khim.* 30, 2356 (1956).
44. M. Haissinsky and M. Cotton, *J. Chim. Phys.* 46, 476 (1949).
45. L. Magos, *J. Chem. Soc. (A)*, 4, 545 (1967).
46. L. Magos, *Brit. J. Industr. Med.* 23, 230 (1966).
47. G. Belmondi and A. Ansaloni, *Ricerca Sci.* 26, 3067 (1956).
48. D. Monnier and L. Loepfe, *Anal. Chim. Acta* 37, 339 (1967).
49. H. Okashita, *Radiochim. Acta* 7, 81 (1967).
50. Y. Kamemoto and S. Yamagishi, *Nippon Genshiryoku Gakkaishi* 4, 611 (1962).
51. Ruch, DeVoe, and Meinke, *Talanta* 9, 33 (1962).
52. DeVoe, Kim, and Meinke, *Talanta* 3, 298 (1960).
53. DeVoe, Nass, and Meinke, *Anal. Chem.* 33, 1713 (1961).
54. W. B. Silker, *Anal. Chem.* 33, 233 (1961).
55. I. H. Qureshi and W. W. Meinke, *Talanta* 10, 737 (1963).
56. Orbe, Qureshi, and Meinke, *Anal. Chem.* 35, 1436 (1963).
57. J. Roesmer, M. S. Thesis, Mainz University (1955).
58. J. E. B. Randles and K. W. Somerton, *Trans. Faraday Soc.* 48 951 (1952).
59. Booth, Audrieth, and Boiler, *Inorganic Synthesis* (McGraw-Hill Co., New York, 1939).
60. G. H. Morrison and H. Freiser, Solvent Extraction in Analytical Chemistry (J. Wiley, New York, 1957).
61. Irving et al., *J. Chem. Soc.*, 1847 (1949).
62. E. B. Sandell, Colorimetric Determination of Traces of Metals (Interscience Publishers, New York, 1944).
63. Irving, Andrews, and Risdon, *J. Chem. Soc.*, 541 (1949).
64. Irving, Risdon, and Andrews, *J. Chem. Soc.*, 537 (1949).
65. H. Friedeberg, *Anal. Chem.* 27, 305 (1955).
66. Furman, Mason, and Pekola, *Anal. Chem.* 21, 1325 (1949).

67. Auger, Lafontaine, and Caspar, *Compt. Rend.* 180, 376 (1925).
68. R. E. Oesper and R. E. Fulmer, *Anal. Chem.* 25, 908 (1955).
69. H. Bode, *Z. Anal. Chem.* 144, 165 (1955).
70. F. Kröhnke, *Ber. Deut. Chem. Ges.* 60, 527 (1927).
71. H. Freiser and G. H. Morrison, *Annual Review of Nuclear Science* (Annual Reviews, Inc., Palo Alto, California, 1959), Vol. 9, p. 221.
72. S. Kitahara, *Bull. Inst. Phys. Chem. Res. (Tokyo)* 24, 454 (1948).
73. T. S. West, *Metallurgia* 53, 132 (1956).
74. H. C. Moser and A. F. Voigt, *J. Inorg. Nucl. Chem.* 4, 354 (1957).
75. Bock, Kusche, and Bock, *Z. Anal. Chem.* 138, 167 (1953).
76. A. R. Denaro and V. J. Occleshaw, *Anal. Chim. Acta* 13, 239 (1955).
77. F. Mylius and C. Huttner, *Ber. Deut. Chem. Ges.* 44, 1315 (1911).
78. R. Bock and M. Herrmann, *Z. Anorg. Allgem. Chem.* 284, 288 (1956).
79. R. Bock, *Z. Anal. Chem.* 133, 110 (1951).
80. P. W. West and J. K. Carlton, *Anal. Chim. Acta* 6, 406 (1952).
81. R. Bock and E. Bock, *Z. Anorg. Allgem. Chem.* 263, 146 (1950).
82. Ishimori, Watanabe, and Fujino, *J. Atomic Energy Soc. Japan* 3, (No. 1) 19 (1961).
83. Ishimori et al., *Data of Inorganic Solvent Extraction* (1), (2), Japan Atomic Energy Research Institute Reports JAERI-1047 (1963) and JAERI-1062 (1964).
84. A. Alian and W. Sanad, *Microchem. J.* 12, 418 (1967).
85. J. C. White and W. J. Ross, *National Academy of Sciences--National Research Council Monograph NAS-NS-3102* (1961).
86. Ishimori, Watanabe, and Nakamura, *Bull. Chem. Soc. Japan* 33, 636 (1960).
87. Hitchcock, Dean, and Handley, *Anal. Chem.* 35, 254 (1963).
88. T. H. Handley and J. A. Dean, *Anal. Chem.* 32, 1878 (1960).
89. T. H. Handley, *Anal. Chem.* 35, 991 (1963).
90. U. Schindewolf, *Z. Elektrochem.* 62, 335 (1958).
91. S. S. Choi and D. G. Tuck, *Inorg. Chem.* 2, 780 (1963).
92. Ichikawa, Uruno, and Imai, *Bull. Chem. Soc. Japan* 34, 952 (1961).
93. H. H. Willard and L. R. Perkins, *Anal. Chem.* 25, 1634 (1953).
94. O. Samuelson, *Ion Exchange in Analytical Chemistry* (Wiley, New York, 1953).



95. O. Samuelson, Ion Exchange Separations in Analytical Chemistry (Almgvist and Wiksell, Goteborg, 1963).
96. F. C. Nachod and J. Schubert, Ion Exchange Technology (Academic Press, New York, 1956).
97. F. Helfferich, Ion Exchange (McGraw-Hill, New York, 1962).
98. K. A. Kraus and F. Nelson, Metal Separations by Anion Exchange (A.S.T.M. Special Technical Publication No. 195, 27-57, 1958).
99. J. Andelin and N. Davidson, Adsorption of Cupric and Mercuric Ions by a Weak-Base Anion Exchange Resin, U. S. Atomic Energy Commission Report AECU-2555 (1957).
100. Hicks et al., The Qualitative Anionic Behavior of a Number of Metals with an Anion Exchange Resin, Dowex-2. Lawrence Radiation Laboratory Report LRL-65 (1953).
101. K. A. Kraus and F. Nelson, Anion Exchange Studies of the Fission Products, in Proceedings of the International Conference on the Peaceful Uses of Atomic Energy (Geneva, 1955), Volume 1, p. 113.
102. K. A. Kraus and G. E. Moore, J. Am. Chem. Soc. 75, 1457 (1953).
103. K. Mizumachi, Nippon Kagaku Zasshi 83, 61 (1962).
104. B. Tremillon, Bull. Soc. Chim. France 1961, p. 275.
105. H. Samsahl, A Chemical Eight Group Separation Method for Routine Use in Gamma Spectrometric Analysis, Aktiebolaget Atomenergi Reports AE-54, and AE-56 (1961).
106. T. Anderson and A. B. Knutsen, Acta Chim. Scand. 16, 849 (1962).
107. Y. Marcus and I. Eliezer, J. Inorg. Nucl. Chem. 25, 867 (1963).
108. J. P. Faris, Anal. Chem. 32, 520 (1960).
109. Nelson, Rush, and Kraus, J. Am. Chem. Soc. 82, 339 (1960).
110. G. Aubouin and J. Laverlochere, Ion Exchange Resin Separation Applied to Activation Analysis, Commissariat à l'Énergie Atomique Report CEA-2359 (1963).
111. R. F. Buchanan and J. P. Faris, Proceedings of the Conference on the Use of Radioisotopes in the Physical Sciences and Industry, Copenhagen, 6-17 Sept. 1960, (International Atomic Energy Agency, Vienna, 1962), p. 361.
112. J. S. Fritz and R. G. Greene, Anal. Chem. 36, 1095 (1964).
113. G. P. Morie and T. R. Sweet, J. Chromatog. 16, 201 (1964).
114. A. K. De and S. K. Majumdar, Z. Anal. Chem. 184, 356 (1961).
115. Nelson, Murase, and Kraus, J. Chromatog. 13, 503 (1964).
116. J. S. Fritz and S. A. Sutton, Anal. Chem. 28, 1300 (1956).
117. S. M. Khopfar and A. K. De, Anal. Chim. Acta 22, 153 (1960).

118. S. M. Khopfar and A. K. De, *Anal. Chim. Acta* 23, 441 (1960).
119. S. K. Majumdar and A. K. De, *Anal. Chim. Acta* 24, 356 (1961).
120. C. W. Koch in University of California Radiation Laboratory Report (Chemistry Division Quarterly Report) UCRL-2531 (1954), p. 39.
121. J. S. Fritz and G. R. Umbreit, *Anal. Chim. Acta* 19, 509 (1958).
122. J. S. Fritz and B. B. Garralda, *Anal. Chem.* 34, 102 (1962).
123. Fritz, Garralda, and Karraker, *Anal. Chem.* 33, 882 (1961).
124. A. K. Majumdar and B. K. Mitra, *Z. Analyt. Chem.* 208, 1 (1965).
125. Strelow, Rethemeyer, and Bothma, *Anal. Chem.* 37, 106 (1965).
126. Maeck, Kussy, and Rein, *Anal. Chem.* 35, 2086 (1963).
127. Bigliocca et al., *Anal. Chem.* 39, 1634 (1967).
128. Gregor, Dolar, and Hoeschele, *J. Am. Chem. Soc.* 77, 36 75 (1955).
129. W. J. Burke (E. I. Dupont de Nemours), U. S. Patent 2, 418, 497 (1947).
130. E. Blasius and M. Laser, *J. Chromatog.*, 11, 84 (1963).
131. A. Lewandowski and W. Szczepaniak, *Z. Analyt. Chem.* 202 (5) 321 (1964).
132. A. Lewandowski and W. Szczepaniak, *Chem. Analit. (Warszawa)* 7, 593 (1962).
133. R. A. Wells, *Quart. Rev. Chem. Soc.* 7, 307 (1953).
134. H. Weil, *Can. Chem. Processing* 38, 68 (1954).
135. S. N. Tewari, *Kolloid Z.* 133, 132 (1953).
136. G. W. Warren and R. W. Fink, *J. Inorg. Nucl. Chem.* 2, 176 (1956).
137. G. W. Warren, Search for New Radioactive Nuclides in the Region of 126 Neutrons, U. S. Atomic Energy Commission Report AECU-3165 (1956).
138. M. Lederer and V. Moscatelli, *J. Chromatog.* 13, 194 (1964).
139. M. Lederer and L. Ossicini, *J. Chromatog.* 13, 188 (1964).
140. J. W. O'Laughlin and C. V. Banks, *Anal. Chem.* 36, 1222 (1964).
141. R. A. Bailey and L. Yaffe, *Can. J. Chem.* 38, 1871 (1960).
142. Sherma et al., *Anal. Chem.* 35, 224 (1963).
143. J. I. Hoffman and G. E. F. Lundell, *J. Res. Natl. Bur. Std. (U.S.)*, 22, 465 (1939).
144. W. Geilmann, *Z. Anal. Chem.* 160, 410 (1958).
145. J. Merinis and G. Bouissieres, *Anal. Chim. Acta* 25, 498 (1961).
146. W. C. Parker and Y. Grunditz, *Nuclear Instr. and Methods* 14, 71 (1961).

147. J. R. DeVoe and W. W. Meinke, *Anal. Chem.* 35, 2 (1963).
148. Beydon et al., *J. Phys. Radium* 19, Suppl. 144A (1958).
149. V. F. Consalvo, Determination of Mercury in Solids from Main Coolant Pump, Knoll's Atomic Power Laboratory Report KAPL-M-VFC-2 (1958).
150. V. Majer in AFC-tr-2937.
151. Reaser et al., *Science* 109, 198 (1949).
152. J. R. DeVoe, Application of Distillation Techniques to Radiochemical Separations, National Academy of Sciences - National Research Council Monograph NAS-NS-3108 (1962).
153. C. F. C. Morris and R. A. Killick, *Talanta* 11, 781 (1964).
154. H. P. Yule, *Anal. Chem.* 37, 129 (1965).
155. T. Westermark and B. Sjöstrand, *Int. J. Appl. Radiation Isotopes* 9, 1 (1960).
156. A. Sola, *Nucleonics* 18, (No. 3) 78 (1960).
157. D. J. Hughes, Pile Neutron Research, (Addison-Wesley, 1953), p. 86.
158. Y. Kamemoto, *Int. J. Appl. Radiation Isotopes* 15, 447 (1964).
159. R. G. Nisle, *Nucleonics* 18, (No. 3) 86 (1960).
160. W. J. C. Bartels, Self-Absorption of Monoenergetic Neutrons, Knolls Atomic Power Laboratory Report KAPL-366 (1950).
161. J. Gilat and Y. Gurfinkel, *Nucleonics* 21, (No. 3) 143 (1963).
162. M. Benedict and T. Pigford, Nuclear Chemical Engineering, Chapters 4-8 (1957).
163. E. Ricci and F. F. Dyer, *Anal. Chem.* 22, 45 (1964).
164. Y. Kamemoto and S. Yamagishi, *Nature* 202, 487 (1964).
165. Y. Kamemoto and S. Yamagishi, *Nippon Kagaku Zasshi* 86, 74 (1965).
166. A. S. Gillespie, Jr. and W. W. Hill, *Nucleonics* 19, (No. 11) 170 (1961).
167. R. Coleman et al., *Proc. Roy. Soc.* 73, 215 (1959).
168. M. Cuypers and J. Cuypers, Investigations in Automated Activation Analysis, Texas A & M University Report TEES-2671-5 (1966), p. 98.
169. Research Staff of Texas Nuclear Corporation, Table of Cross Sections for Fast Neutron Reactions, Second Edition, January 1964.
170. R. W. Fink, Measurements by Improved Methods of Activation Cross Sections for 14.4-MeV Neutron Reactions, in: Proceedings of the Conference on the Use of Small Accelerators for Teaching and Research, Oak Ridge, April 8-10, 1968, CONF-680411 (1968).
171. B. T. Kenna and F. J. Conrad, Tabulation of Cross Sections, Q-Values, and Sensitivities for Nuclear Reactions of Nuclides with 14-MeV Neutrons, Sandia Laboratory Report SC-RR-66-229 (1966).

172. J. Perdijon, *Anal. Chem.* 39, 448 (1967).
173. K. G. Broadhead and D. E. Shanks, *Intern. J. Appl. Radiation Isotopes* 18, 279 (1967).
174. Sister L. M. Menapace, Use of Metastable States in Activation Analysis, Ames Laboratory Report IS-T-196 (1967).
175. Lukens, Otvos, and Wagner, *Intern. J. Appl. Radiation Isotopes* 11, 30 (1961).
176. Lukens, Graber, and Perry, *Trans. Am. Nucl. Soc.* 10, 90 (1967).
177. Oka et al., *Bull. Chem. Soc. Japan* 40, 575 (1967).
178. Asai et al., *Ann. Rep. Radiat. Center, Osaka Prefect.* 8, 120 (1967).
179. Burrows et al., *Strahlentherapie Sonderbande* 65, 365 (1967).
180. C. A. Baker and D. A. Wood, A Catalogue of 30-MeV Gamma Activation Products - Part II. Ruthenium to Bismuth, Atomic Energy Research Establishment Report AERE-R-5818 (1968).
181. Lobanov, Romanov, and Khaidarov, Radiatsionnye Effekty v Kondensirovannykh Sredakh (Publishing House of the Sciences, Tashkent, 1964).
182. T. I. Isenhour and G. H. Morrison, *Anal. Chem.* 38, 162 (1966).
183. R. C. Greenwood, Scintillation Spectrometer Measurements of Capture Gamma Rays from Natural Elements, Armour Research Foundation Reports ARF 1193-3 (1961), 1193-6 (1962), 1193-9 (1962), 1193-12 (1962), 1193-17 (1962), 1193-20 (1963), 1192-23 (1963), and 1192-26 (1963).
184. Adyascovich, Groshev, and Demidov, "Conference of the Academy of Sciences of the USSR on the Peaceful Uses of Atomic Energy", Session of the Division of Physics and Mathematical Sciences, (Consultant's Bureau, New York, 1955) p. 195.
185. B. B. Kinsey and G. A. Bartholomew, *Can. J. Phys.* 31, 1051 (1953).
186. R. E. Segel, *Bull. Am. Phys. Soc.* 2, 230 (1957) and *Bull. Am. Phys. Soc.* 3, 64 (1958).
187. Estulin, Kalinkin, and Melioranski, *Soviet Physics JETP* 5, 801 (1957) and *Nuclear Physics* 4, 91 (1957).
188. Plaksin, Starchik, and Malysheva in Trudy I Vsesoyuznogo koordinatsionnogo soveshchaniya po aktivatsionnomu analizu; *Yadern. Fiz. Akad. Nauk Uz. SSR, Tashkent, 1962 (AEC-tr-6639)*, p. 114-17.
189. N. G. Malysheva, *Nauchn. Soobshch., Inst. Gorn. Dela, Akad. Nauk SSSR* 19, 106 (1963).
190. N. G. Malysheva and L. P. Starchik, *ibid.* 29, 102 (1965).
191. Plaksin, Malysheva, and Starchik, *Zavodsk. Lab.*, 30, 824 (1964).
192. J. Ruzicka and J. Stary, *Talanta* 8, 535 (1961).
193. J. H. Yoe and H. J. Koch, Trace Analysis (J. Wiley, New York, 1955).

194. N. Suzuki, Proceedings of the Second Japan Conference on Radioisotopes, February 1958, Tokyo, U. S. Atomic Energy Commission Report AEC-tr-4482 (1958), p. 410.
195. T. M. Khrenkova, Zavod. Lab. No. 7, 1960.
196. P. Schiller and J. Majer, Acta Chim. Hung. 26, 259 (1961).
197. Filippov, Rusyaev, and Kuznetsov, Geol. Geofiz., Akad. Nauk SSSR, Sib. Otd., 130-51 (1966).
198. R. L. Heath, Gamma Ray Spectra Catalogue, U. S. Atomic Energy Commission Report IDO-16880-2 (1964).
199. Strominger, Hollander, and Seaborg, Rev. Mod. Phys. 30, 585 (1958).
200. Joly et al., Helv. Phys. Acta 28, 403 (1955).
201. Broyles, Thomas, and Haynes, Phys. Rev. 89, 715 (1953).
202. Gray, Phys. Rev. 101, 1306 (1956).
203. J. H. Neiler and P. R. Bell in Alpha, Beta, and Gamma-Ray Spectroscopy (K. Siegbahn Ed., Vol. I, North Holland Publishing Co., Amsterdam, 1965).
204. Vegors, Marsden, and Heath, Calculated Efficiencies of Cylindrical Radiation Detectors, U. S. Atomic Energy Commission Report IDO-16370 (1958).
205. R. K. Doerner and A. H. Weber, Phys. Rev. 99, 672 (1955).
206. L. Górski, Nukleonika, 6, 399 (1961).
207. The Radiochemical Manual. Part I. Physical Data, The Radiochemical Centre, Amersham, Bucks, England 1962.
208. Reed, Kigoshi, and Turkevich, Geochim. Cosmochim Acta 20, 122 (1960).
209. E. Esteve, Chem. Ztg. 35, 1152 (1911).
210. T. T. Gorsuch, Analyst, 84, 135 (1959).
211. Pijck, Hoste, and Gillis, in Proceedings of the International Symposium on Microchemistry (Pergamon Press, London, 1958), p. 48.
212. E. B. Sandell, Colorimetric Determination of Metals (Interscience Publishers, Inc., New York, N. Y., 1959, third ed.), p. 622.
213. G. Leliaert, Pure and Appl. Chem. 1 (No. 1), 121 (1960).
214. P. O. Bethge, Anal. Chim. Acta 10, 317 (1954).
215. Samsahl, Brune, and Wester, Intern. J. Appl. Radiation Isotopes 16, 273 (1965).
216. K. Samsahl, Nukleonik 8, 252 (1966).
217. Hillebrand et al., Applied Inorganic Analysis (John Wiley and Sons, Inc., New York, N. Y., 1953, 2nd ed.).
218. N. H. Furman, Standard Methods of Chemical Analysis (Van Nostrand, New York, 1962, 2nd ed.).

219. H. Funk, M. Lehl-Thalinger and E. Pohland, Handbuch der Analytischen Chemie (Springer-Verlag, Berlin, 1945). Vol. III, Band IIb.
220. G. Iwantscheff, Das Dithizon und seine Anwendung in der Mikro- und Spurenanalyse, (Weinheim, 1958).
221. J. Stary, The Solvent Extraction of Metal Chelates (Pergamon, Oxford, 1964).
222. O. A. Weber, 15th Intern. Cong. Occupational Health 3, 75 (1966).
223. R. Mappes, *ibid.*, 3, 65 (1966).
224. T. W. Clarkson *Ann. Occup. Hyg.* 8, 73 (1965).
225. T. W. Clarkson, A. Rothstein and R. Sutherland, *Brit. J. Pharmacol.* 24, 1 (1965).
226. T. W. Clarkson and L. Magos, *J. Biochem.* 99, 62 (1966).
227. W. Kiesl, *Z. Analyt. Chem.* 227, 13 (1967).
228. Andersen et al., Photonuclear Activation Analysis of Biological Materials for Various Elements, including Fluorine, Proceedings of the Symposium on Nuclear Activation Techniques in the Life Sciences, Amsterdam 8-12 May 1967 (International Atomic Energy Agency, Vienna, 1967) pp 99.

## VIII. APPENDIX I.

All presently available data on the elution behavior of mercury (II) from Dowex-1 anion exchangers as a function of type and concentration of the anion are summarized in Figure 63.

The curve marked  $\text{NH}_4\text{F}$  refers to hydrochloric acid solutions which contain 2 to 10 percent by weight of  $\text{NH}_4\text{F}$ .<sup>227</sup> The mercury distribution data were taken from reference 101 for the HCl system, from reference 106 for the HBr system, from reference 108 for the HF system, from reference 111 for the  $\text{HNO}_3$  system, and from reference 227 for the  $\text{H}_3\text{PO}_4$  system.

The elution behavior of mercury (II) from Dowex-50 cation exchangers has been summarized in Figure 23.

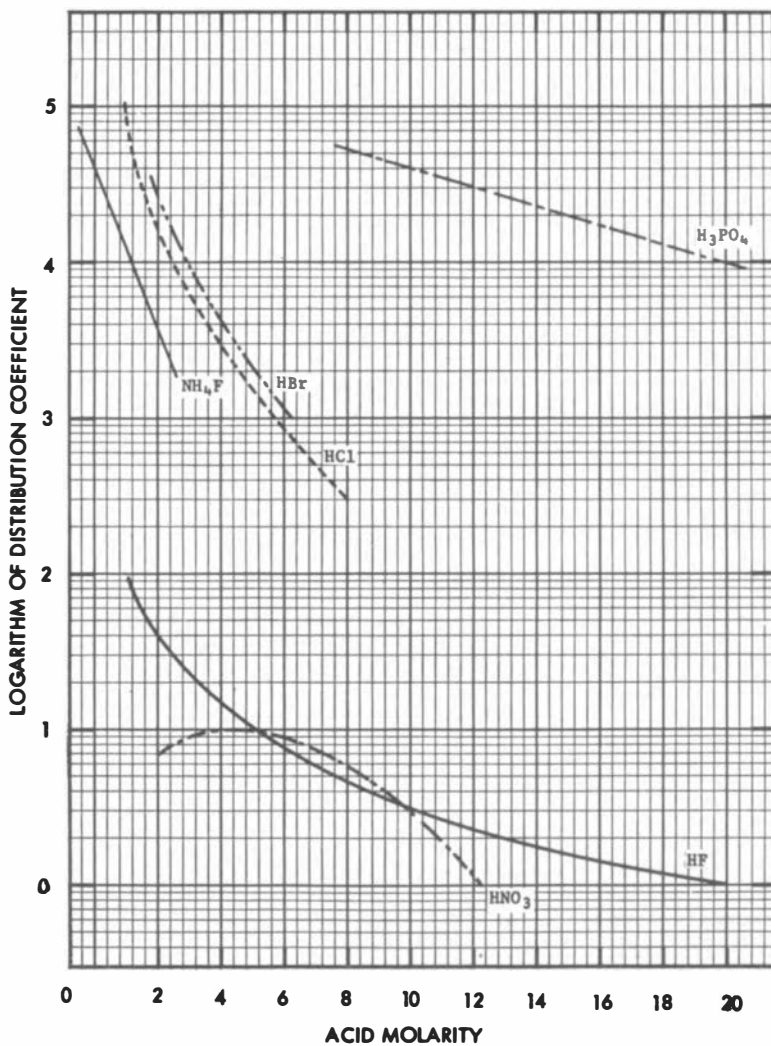

Figure 63. Elution behavior of Hg(II) from Dowex-1 as a function of acid molarity and anion.

CREDITS FOR COPYRIGHTED MATERIAL PREPRINTED  
WITH PERMISSION IN THIS MONOGRAPH

Tables	Page	Source
I	2	From Lederer, Hollander, and Perlman, <u>Table of Isotopes</u> , 6th edition, 1967, John Wiley & Sons, Inc.
IV	9	From C. L. Gordon et al., <u>Ann. N. Y. Acad. Sci.</u> , 65: 369 (1957). Copyright, The New York Academy of Sciences, 1957.
VII, VIII	19, 20	From A. C. Wahl and N. A. Bonner, <u>Radioactivity Applied to Chemistry</u> , 1951, John Wiley & Sons, Inc.
XIV, XV	36, 38	From T. H. Handley, <u>Anal. Chem.</u> , 35: 991 Copyright, The American Chemical Society.
XVIII	47	From J. S. Fritz and R. G. Green, <u>Anal. Chem.</u> , 36: 1095 (1964). Copyright, The American Chemical Society.
XIX, XX	52, 53	From J. S. Fritz and B. B. Gerralda, <u>Anal. Chem.</u> , 34: 102 (1962). Copyright, The American Chemical Society.
XXI	53	From Fritz, Gerralda, and Karraker, <u>Anal. Chem.</u> , 33: 882 (1961). Copyright, The American Chemical Society.
XXII	55	From Strelow, Rethemeyer, and Bothma, <u>Anal. Chem.</u> , 37: 106 (1965). Copyright, The American Chemical Society.
XXIII, XXIV, XXV	64, 65, 66	From J. W. O'Laughlin and C. V. Banks, <u>Anal. Chem.</u> , 36: 1222 (1964). Copyright, The American Chemical Society.
XXVIII	70	From H. P. Yule, <u>Anal. Chem.</u> , 37: 129 (1965). Copyright, The American Chemical Society.



CREDITS FOR COPYRIGHTED MATERIAL REPRINTED  
WITH PERMISSION IN THIS MONOGRAPH  
(Continued)

Figs.	Page	Source
1	6	From Knolls Atomic Power Laboratory, Schenectady, N. Y., operated by the General Electric Company for the U. S. Atomic Energy Commission, Naval Reactors Branch.
2	8	From C. L. Gordon et al., <u>Ann. N. Y. Acad. Sci.</u> , 65: 369 (1957). Copyright, The New York Academy of Sciences, 1957.
3, 4, 5, 6, 7, 8	28, 29, 31, 32	From H. Freiser and G. H. Morrison, Solvent Extraction in Radiochemical Separations, <u>Annu. Rev. Nucl. Sci.</u> , 9: 221-244 (1959). Copyright, Annual Reviews, Inc.
10, 11	35	From T. H. Handley and T. A. Dean, <u>Anal. Chem.</u> , 32: 1878 (1960). Copyright, The American Chemical Society.
12, 13	37	From T. H. Handley, <u>Anal. Chem.</u> , 35: 991 (1963). Copyright, The American Chemical Society.
17	45	From J. P. Harris, <u>Anal. Chem.</u> , 32: 520 (1960). Copyright, The American Chemical Society.
27, 28, 29, 30	57, 58	From Maeck, Kussy, and Rein, <u>Anal. Chem.</u> , 35: 2086 (1963). Copyright, The American Chemical Society.
31	59	From Bigliocca et al., <u>Anal. Chem.</u> , 39: 1634 (1967). Copyright, The American Chemical Society.
49, 50	155, 157	From B. Sjostrand, <u>Anal. Chem.</u> , 36: 814 (1964). Copyright, The American Chemical Society.
51, 52	158, 161	From K. Samsahl, <u>Anal. Chem.</u> , 39: 1480 (1967). Copyright, The American Chemical Society.