



Space Station Engineering and Technology Development: Proceedings of the Panel on Solar Thermodynamics Research and Technology Development, July 31, 1985 (1985)

Pages
92

Size
8.5 x 10

ISBN
0309323029

Ad hoc Committee on Space Station Engineering and Technology Development; Aeronautics and Space Engineering Board; Commission on Engineering and Technical Systems; National Research Council

 [Find Similar Titles](#)

 [More Information](#)

Visit the National Academies Press online and register for...

- ✓ Instant access to free PDF downloads of titles from the
 - NATIONAL ACADEMY OF SCIENCES
 - NATIONAL ACADEMY OF ENGINEERING
 - INSTITUTE OF MEDICINE
 - NATIONAL RESEARCH COUNCIL
- ✓ 10% off print titles
- ✓ Custom notification of new releases in your field of interest
- ✓ Special offers and discounts

Distribution, posting, or copying of this PDF is strictly prohibited without written permission of the National Academies Press. Unless otherwise indicated, all materials in this PDF are copyrighted by the National Academy of Sciences.

To request permission to reprint or otherwise distribute portions of this publication contact our Customer Service Department at 800-624-6242.

Copyright © National Academy of Sciences. All rights reserved.



REFERENCE COPY
FOR LIBRARY USE ONLY

Space Station Engineering and Technology Development

Proceedings of the Panel on
Solar Thermodynamics Research
and Technology Development
July 31, 1985

Ad hoc Committee on Space Station Engineering
and Technology Development

Aeronautics and Space Engineering Board

Commission on Engineering and Technical Systems

National Research Council

Order from
National Technical
Information Service,
Springfield, Va.

22161

Order No. ~~DTIC 11076~~

PB 88-210703

NATIONAL ACADEMY PRESS
Washington, D. C. 1985

NAS-NAE

NOV 5 1985

LIBRARY

TL
797
.5622
1985
C.1

NOTICE: The project that is the subject of this report was approved by the Governing Board of the National Research Council, whose members are drawn from the councils of the National Academy of Sciences, the National Academy of Engineering, and the Institute of Medicine. The members of the committee responsible for the report were chosen for their special competences and with regard for appropriate committee balance.

This report has been reviewed by a group other than the authors according to procedures approved by a Report Review Committee consisting of members of the National Academy of Sciences, the National Academy of Engineering, and the Institute of Medicine.

The National Research Council was established by the National Academy of Sciences in 1916 to associate the broad community of science and technology with the Academy's purposes of furthering knowledge and of advising the federal government. The Council operates in accordance with general policies determined by the Academy under the authority of its congressional charter of 1863, which establishes the Academy as a private, nonprofit, self-governing membership corporation. The Council has become the principal operating agency of both the National Academy of Sciences and the National Academy of Engineering in the conduct of their services to the government, the public, and the scientific and engineering communities. It is administered jointly by both Academies and the Institute of Medicine. The National Academy of Engineering and the Institute of Medicine were established in 1964 and 1970, respectively, under the charter of the National Academy of Sciences.

This report and the study on which it is based were supported by Contract No. NASW-4003 between the National Aeronautics and Space Administration and the National Academy of Sciences.

Copies of this publication are available from:

Aeronautics and Space Engineering Board
National Research Council
2101 Constitution Avenue, N.W.
Washington, D.C. 20418

Printed in the United States of America

Panel on Solar Thermodynamics Research and Technology Development

Members

JOSEPH F. SHEA (Chairman), Senior Vice-President, Engineering,
Raytheon Company
RICHARD W. HESSELBACHER, Manager, Division Advanced Development and
Information Systems, Space System Division, and President,
Management and Technical Services Company, General Electric Company
KENNETH F. HOLTBY, Senior Vice President, The Boeing Company
ARTUR MAGER, Consultant
WALTER B. OLSTAD, Director, Strategic Planning, Lockheed-California
Company

NASA Liaison Representatives

RICHARD F. CARLISLE, Deputy Director, Engineering Division, Space
Station Office
JAMES M. ROMERO, Assistant Director for Space Station Technology,
Office of Aeronautics and Space Technology

ASEB Staff

BERNARD MAGGIN, Project Manager
JULIE A. FERGUSON, Project Assistant

PRESENTORS

JERRY M. FRIEFELD, Rocketdyne
JAMES HIEATT, TRW
JOHN KLINEBERG, NASA Lewis Research Center
DAVID NAMKOONG, NASA Lewis Research Center
RICHARD L. PUTHOFF, NASA Lewis Research Center
RONALD L. THOMAS, NASA Lewis Research Center
DWAYNE WEARY, NASA Johnson Space Center

INDUSTRY ATTENDEES

MERV AULT, Gateway Tech. Association, Inc.
MIKE CERNECK, TRW
ROGER B. GILLETTE, Boeing Aerospace Company

ROBERT HABERMAN, Sundstrand
ALLAN HAUSE, Garrett
JOHN LAUFFER, Rocketdyne
RON McKENNA, Sundstrand
R. V. PERDEW, Harris
TONY PIETSCH, Garrett

NASA ATTENDEES

JUDITH H. AMBRUS, Headquarters
C. BARAONA, Lewis Research Center
D. T. BERNATOWICZ, Lewis Research Center
HENRY W. BRANDHURST, Lewis Research Center
JOHN CASSIDY, Lewis Research Center
W. A. CHANDLER, Johnson Space Center
HARRY DAVISON, Lewis Research Center
JIM FADDOUL, Lewis Research Center
JEFF FARMER, Langley Research Center
J. STUART FORDYCE, Lewis Research Center
A. F. FORESTIERI, Lewis Research Center
R. FRYE, Lewis Research Center
WILLIAM GOETTE, Lewis Research Center
JOHN KOBAK, Lewis Research Center
TED MROZ, Lewis Research Center
DON NORED, Lewis Research Center
LEWIS L. PEACH, JR., Headquarters
ROBERT ROSEN, Headquarters
EARL VANLANDINGHAM, Headquarters

Ad hoc Committee on Space Station Engineering and Technology Development

Members

JOSEPH F. SHEA (Chairman), Senior Vice-President, Engineering,
Raytheon Company
LAWRENCE R. GREENWOOD, Vice-President, Strategic Operations,
Ball Aerospace Systems Division
JOHN V. HARRINGTON, Consultant
DONALD P. HEARTH, Director of Space Sciences and Technology,
University of Colorado
RICHARD W. HESSELBACHER, Manager, Division Advanced Development and
Information Systems, Space System Division, and President,
Management and Technical Services Company, General Electric Company
KENNETH F. HOLTBY, Senior Vice-President, The Boeing Company
ARTUR MAGER, Consultant
SIDNEY METZGER, Sidney Metzger and Associates, Engineering Consultants
WALTER B. OLSTAD, Director, Strategic Planning, Lockheed-California
Company
JAMES T. ROSE, Director, Electrophoresis Operations in Space,
McDonnell-Douglas Astronautics Company
ALTON D. SLAY, Slay Enterprises, Inc.
CLARENCE A. SYVERTSON, Consultant
BYRON D. TAPLEY, Clare Cockrell Williams Chair of Engineering,
Department of Aerospace Engineering, University of Texas
LAURENCE R. YOUNG, Professor of Aeronautics and Astronautics,
Massachusetts Institute of Technology

ASEB Staff

BERNARD MAGGIN, Project Manager
JULIE A. FERGUSON, Project Assistant

Aeronautics and Space Engineering Board

Members

JOSEPH F. SHEA (Chairman), Senior Vice-President, Engineering,
Raytheon Company
MAX E. BLECK, President and Chief Executive Officer, Piper Aircraft
Corporation
BERNARD BUDIANSKY, Professor of Structural Mechanics,
Harvard University
W. BOWMAN CUTTER III, Coopers and Lybrand
R. RICHARD HEPPE, President, Lockheed-California Company
RICHARD W. HESSELBACHER, Manager, Division Advanced Development and
Information Systems, Space System Division, and President,
Management and Technical Services Company, General Electric Company
KENNETH F. HOLTBY, Senior Vice-President, The Boeing Company
JAMES J. KRAMER, Manager, Advanced Technology Programs, General
Electric Company
PETER W. LIKINS, President, Lehigh University
DONALD J. LLOYD-JONES, Consultant
STEPHEN F. LUNDSTROM, Associate Professor in Electrical Engineering
(Research), Center for Integrated Systems, Stanford University
ARTUR MAGER, Consultant
STANLEY MARTIN, JR., Vice-President, V-22 Engineering, Bell
Helicopter Textron
JOHN F. McCARTHY, JR., Northrop Corporation
JOHN L. McLUCAS, Communications Satellite Corporation
IRWIN MENDELSON, President, Engineering Division, Pratt and Whitney
Aircraft Group
JAN ROSKAM, Ackers Distinguished Professor of Aerospace Engineering
and Director, Flight Research Laboratory, University of Kansas
THOMAS O. PAINE, Thomas Paine Associates
ROGER D. SCHAUFLELE, Vice-President, Engineering, Douglas Aircraft
Company, McDonnell Douglas Corporation
RICHARD S. SHEVELL, Professor, Department of Aeronautics and
Astronautics, Stanford University
ROBERT E. SKELTON, Professor of Aeronautics Engineering,
Purdue University
ALTON D. SLAY, Slay Enterprises, Inc.
MORRIS A. STEINBERG, Vice-President, Science, Lockheed Corporation
LAURENCE R. YOUNG, Professor of Aeronautics and Astronautics,
Massachusetts Institute of Technology

Executive Staff

ROBERT H. KORKEGI, Executive Director
A. J. EVANS, Senior Professional Associate
BERNARD MAGGIN, Senior Professional Associate
LAURA D'SA, Administrative Secretary
JULIE A. FERGUSON, Senior Secretary

Preface

At the request of the National Aeronautics and Space Administration (NASA), the Aeronautics and Space Engineering Board (ASEB) undertook a study of NASA's space station program in 1984. The results of this study by the ASEB's ad hoc committee on Space Station Engineering and Technology Development were published in February 1985. NASA found the study useful and asked the ASEB to continue examination of the evolving space station program through a series of specific studies on:

- maintainability
- research and technology in space
- solar thermodynamics research and technology
- program performance
- onboard command and control
- research and technology road maps

This report of proceedings documents the third of this series of studies--solar thermodynamics research and technology. The study provides NASA with comments on current program activity and future plans with regard to satisfying potential space station electric power generation requirements.

The panel consisted of selected members of the committee with special knowledge and experience in the science, art, and engineering pertinent to solar thermodynamics research and technology development. The panel was briefed by experienced NASA and industry representatives. Following panel discussion of the data, general observations were developed.

These proceedings contain a brief synopsis of the presentations to the panel, including panel comments, and a summary of the panel's observations for NASA's consideration. For completeness, selected presentation material is appended.

The panel met at the NASA Lewis Research Center on July 31, 1985 to review the status of the NASA solar thermodynamic electric power generating technology development in support of the space station

definition and preliminary design effort. The report of these proceedings is attached.

The panel found that NASA has acted very responsibly on the findings of the earlier committee review and commentary on NASA's electric power generating program. The panel found the current program to be broad enough and with sufficient depth to allow analyses and choices to be made on a sound technology base. Program schedules are tight but manageable. It was clear to the panel that the organization, plans, and implementation are being pursued with a "can do" attitude, so that there is high confidence that the appropriate work can be accomplished and appropriate system choices made.

Joseph F. Shea
Chairman, Panel on Solar Thermodynamic
Research and Technology Development

Acknowledgments

The panel appreciates the time and attention given by NASA and contractor personnel to the briefings and discussions of the important subject of space station electric power generation. The future effectiveness of the space station will depend on the effectiveness of this system. Solar thermodynamics may well have a significant role. It is in this regard that the presentations and related dialogue were of special assistance in assessing program appropriateness.

The panel recognizes that the space station program is in its formative stage. Concept studies, soon to lead to preliminary design, are under way. The work discussed with the panel is directed at laying the technology base for design and performance analyses. The panel understands that these data have to be fitted with other data before hard decisions can be made on initial and growth space station electric power generation. In its review, the panel was sensitive to the need for the development of an early data base for future decisions on the electric power generating system.

Contents

1. INTRODUCTION	1
Background, 1	
Task of the Panel on Solar Thermodynamics Research and Technology Development, 2	
2. BRIEFINGS	5
Welcome, 5	
Overview of NASA-Lewis Research Center Solar Dynamics Program, 5	
Status of Program, 8	
In-house Testing, 11	
Contractor Phase B Activity	
Rocketdyne, 12	
TRW, 12	
Level B Perspective, 13	
3. SUMMARY COMMENTS	15

APPENDIXES

- A. Meeting Agenda, 17
- B. Briefing Graphics, 19
- C. Electric Power Generation Technology Development
 Studies Procurement Status, 79

1

Introduction

BACKGROUND

In 1984 the ad hoc committee on Space Station Engineering and Technology Development of the Aeronautics and Space Engineering Board (ASEB) conducted a review of the National Aeronautics and Space Administration's (NASA) space station program planning. The review addressed the initial operating configuration (IOC) of the station. The committee's study was released in February 1985. NASA factored the results of the study into its Phase B (concept and preliminary design) request for proposals issued to industry in September 1984 and awarded in April 1985.

As a result of this work, NASA asked the ASEB to reconstitute the ad hoc committee to address:

- onboard maintainability and repair
- in-space research and technology program and facility plans
- solar thermodynamic research and technology development program planning
- program performance (cost estimating, management, and containment)
- onboard versus ground-based mission control
- technology development road maps from IOC to the growth station

The objective of these new assignments is to provide NASA with advice on ways and means for improving the content, performance, and/or effectiveness of these elements of the space station program.

In response, the ASEB reconstituted the ad hoc committee, which established panels to address each subject. The panel participants, from the committee, industry, and universities, bring to each panel experience in the area of special interest.

In view of NASA's interest in program definition and development, the decision was made to address the subjects of maintainability, program performance, and onboard mission control in roundtable forums focusing on concepts, system design, and organization. The subjects

of research and technology in space, solar thermodynamic research and technology development, and technology development road maps were to be addressed in workshops focused on NASA program activity and plans.

To expedite the documentation and dissemination of the information, the deliberations of the panels are being reported as proceedings. The proceedings of the Panel on Maintainability were published in May 1985; the proceedings of the Panel on In-Space Engineering Research and Technology Development, in August 1985. The proceedings of the Panel on Solar Thermodynamics Research and Technology Development (R&T) are presented in this report.

TASK OF THE PANEL ON SOLAR THERMODYNAMICS RESEARCH AND TECHNOLOGY DEVELOPMENT

The reasons for the interest in solar thermodynamic electric power generating systems compared with solar photovoltaic systems for electric power generation lie in the number of potential benefits of the former systems. These benefits, noted here, outweigh assessed disadvantages:

- Improved system efficiency (some 20-25 percent versus 10 percent)
- Reduced frontal area (about one-third) and weight (about one-half)
- Lower drag, altitude of operation for the station, and simpler logistics
- Passive energy storage (no batteries) and direct AC power generation
- More growth potential

The task statement for the Panel on Solar Thermodynamics Research and Technology Development notes:

One of the most challenging elements of the space station program is the selection of the power generation system. Present requirements, based on projected levels of utilization, indicate the need for 75 kW for IOC and growth to 300 kW before the end of the century. The largest photovoltaic power system utilized in space to this date has been on Skylab (25 kW design, 10 kW actual). The photovoltaic technology, however, is inappropriate, especially for the large levels of power associated with space station growth and maintainability requirements associated with long life.

The growth of the photovoltaic arrays is limited by size and related drag. Therefore, it was decided to pursue the development of a solar thermodynamic power system to satisfy the larger power needs. This technology offers the potential for a three to four fold reduction in collector area due to higher system efficiency and allows easier accommodation of the large power requirement. For these reasons, NASA has initiated a technology development program concentrating on selected critical solar thermodynamic technologies.

In an earlier meeting, the ASEB Committee on Space Station Engineering and Technology Development reviewed the state of the technology related to solar thermodynamics systems and recommended acceleration of the technology development program. At this meeting, a status report on program progress and plans will be presented and the panel will have an opportunity to dialogue with NASA program managers on the future direction of this work.

NASA will present its advanced development program in solar thermodynamics: its goals, objectives, and milestones related to the space station definition and development activity, its engineering master schedule.

The Phase B contractors for the space station power system (Work Package 4) will present their related current and planned activity.

The panel's comments and opinions on the following are desired:

- Are all critical technologies covered adequately in the present program?
- Are the milestones realistic and achievable in view of the overall space station program milestones?
- Are the technical approaches and planned analyses likely to lead to clear-cut decisions within the time constraints?
- Are adequate preparations being made to accommodate a solar thermodynamic system should such a decision be made?

The proceedings record the panel's meeting held at the NASA Lewis Research Center on July 31, 1985. The list of panel members and participants is presented on pages iii-iv. After the panel was briefed by NASA and industry representatives, it held a general discussion and developed its findings. These activities and panel comments are reported here without attribution.

2

Briefings

The briefing material is contained in Appendix B with the exception of the material used by the space station Phase B contractors, Rocketdyne and TRW. The contractor presentations are considered proprietary and privileged and, when presented, representatives of the other contractor were not present.

The following paragraphs summarize the briefings and include panel comments. The contractor briefings are described only in outline form.

Welcome--John Klineberg, NASA Lewis Research Center The space station electric power generation responsibility is taken very seriously by the Center, and the technology development program has the full support of Center management. This fact should become evident from the briefings to be presented to the panel. Current budget constraints will have an impact on the space station program. Its funding is being reduced by some \$30 million, leaving about \$200 million in the program for next fiscal year. It is planned to hold the electric power program funding at the proposed level because of the importance of this work.

Overview of NASA-Lewis Research Center Solar Dynamics Program--Ronald Thomas, NASA LeRC The LeRC Space Station Systems Directorate has a staff of 135. There is a plan to increase the staff to 185 next year in response to program growth. The major program thrust is in support of the initial operating configuration (IOC) of the space station. Other groups at LeRC support the longer term research and advanced technology space power generation and control activity.

Four offices make up the Space Station System Directorate: Power Systems Contracts, Power Systems Engineering, Advanced Programs and Planning, and Power Systems Integration. The Contracts Office manages the two Phase B (concept/preliminary design) Work Package 4, Power System, contracts. The contractors are Federal Systems of TRW Space and Technology Group and Rocketdyne of Rockwell International. In addition to the Phase B contracts, LeRC has some 20 additional tech-

Most of the contracts have been awarded; those that have not should be awarded by late summer 1985.

The Engineering Office, with some 80 people assigned, is responsible for subsystem technical activity including trade analyses and hardware and software testing and validation. The staff interfaces with the program Level B systems engineering and integration office at the NASA Johnson Space Center (JSC) and the Level C offices at the other NASA centers.* The Programs and Planning Office is responsible for advanced technology development related to evolutionary systems (beyond IOC). This work includes evolutionary analyses, commercialization, project support, and costing. The Integration Office has primary responsibility for system interface and requirement definition activity.

The Directorate is very sensitive to the need for high confidence in the technology and the associated costs for system development and for operations. Costs will be an important aspect of the trades analyses that will be made between solar photovoltaic and solar thermodynamic electric power generating systems for the space station.

A solar photovoltaic electric power generation system is being used as the reference system for design and analysis. Only limited technology development work is directed at this system because the technology is reasonably well in hand. Particular attention is being given to energy storage cells and photovoltaics for the space station's unmanned platforms.

The approved program option is solar thermodynamics because of the potential advantages of such systems (increased power with reduced area) over photovoltaic systems. The contractors and the Center are giving these systems (Rankine and Brayton) most of their attention. The Stirling system is under active study, but is considered more appropriate for the growth station due to the state of technology development. Nuclear power is being examined as a longer term option.

At this time, the goal is to design the space station so that it can accept either photovoltaic or thermodynamic systems. The ability to accommodate either option means that the electric power distribution and control system must be appropriately designed. This is being done. There is a possibility that IOC will use a hybrid electric power generating system.

Extensive trade studies are both under way and planned. Both Phase B contractor and in-house activity are involved. Such matters as performance and costs for initial systems, transport and assembly,

* The Level A office is the overall space station program management office at NASA Headquarters. The Level B office is the space station program technical management office at NASA JSC. Level C offices are space station offices at various NASA centers responsible for major engineering contract activity as assigned. Level C reports to Level B and Level B to Level A.

and operations and maintenance will be examined. Questions of high voltage and direct current versus alternating current will be considered.

Present thinking is that the IOC may go to 100 kW. The original target for IOC was 75 kW. Much of the demand for electric power is associated with the use of electricity to generate heat for melting material. In this regard, some thought has been given to use of direct solar heating devices (solar energy concentrators). Matters such as hot fluid transfer, convenience, and control tend to lead to the use of electricity for this kind of activity. However, the idea deserves continued examination, particularly for self-contained experiments.

Particular attention is to be given to growth paths for selected power generating systems to minimize the time, trouble, and costs associated with system change. The studies will identify advanced technology and technology development requirements and provide the basis for advanced program planning and funding.

The present technology program is dedicated to developing the technology to a point of maturity that permits reasonable quantification of performance and costs associated with system development and operation. All appropriate components will be built and tested to validate performance and operations. This action is directed at reducing design and development risks. One such effort involves what is termed the alpha joint (the ring for electric power transfer) that allows the 360° rotation required per orbit between the space station structure and the power generation system structure.

The development effort can be expected to be costly. All contractors are directed to pursue their work with the objective of reducing and holding down design, development, test, and engineering costs. The Directorate will use performance and costs as two important factors in the process of final contractor selection.

System development will include testing of solar concentrators, receivers, and power generators. To the degree possible, this testing will take place on the ground. When absolutely necessary, for key components, Shuttle flight experiments will be conducted to validate design. There does not appear to be a need for all-up-system ground or flight tests, at this time.

Because the Shuttle can be expected to have manifest-load problems, early identification of in-space test needs is dictated.

Although compatible with the space station development schedule, the electric power generation technology development program will require careful attention to meet this schedule, and management will be required to handle the program expeditiously.

Funding for program support is considered marginal but adequate by the Directorate. NASA's total budget for space station electric power systems (\$11 million in FY 1985 and \$15 million in FY 1986) may be

reduced some 10 percent in FY 1986. The LeRC Space Station Directorate share (\$7.4 million in FY 1985 and \$9.8 million in FY 1986) is not expected to be affected. The major part of the budget at LeRC is devoted to solar thermodynamics work--53 percent for FY 1986. The next largest cost item is power management and distribution--39 percent. The smallest part of the program, related to photovoltaic technology development, is devoted primarily to regenerative fuel cells.

The Directorate believes that: LeRC is organized and aggressively pursuing the solar thermodynamic electric power generation option; the work is in place and will result in a sound technology data base for selection of the space station electric power generation system; the necessary data will be available in time to address key issues and select the option for preliminary design; and design of the space station itself is being pursued in a manner to allow use of the photovoltaic and/or thermodynamic option. Although the budget is lean, it is considered sufficient to allow appropriate data development for in-depth examination of the solar thermodynamic option.

The interim requirements review (IRR) is scheduled for January 1986. The Directorate has not identified the selection criteria for an electric power generating system decision. The technology and trades analyses are to be used to identify what are termed "show stoppers," risks, and benefits. There is no intention to carry more than one system option too long. However, since photovoltaics is considered on-the-shelf technology and does not need a large infusion of technology, it may be possible to defer a selection decision until the initiation of Phase C/D (final design/development).

As noted, a photovoltaic system may be the choice for platforms. Therefore, appropriate photovoltaic effort will be supported. The option will be maintained also for the space station. It is apparent that if the advantages of thermodynamics are great enough, some added risk associated with the application of this system may be worth accepting.

Status of Program--David Namkoong, NASA LeRC The two solar thermodynamics systems receiving detailed attention, Rankine and Brayton, have the nominal characteristics noted in Table 1. These systems

TABLE 1 Comparison of Rankine and Brayton Systems			
System	Efficiency (percent)	Working fluid	Temperature (max., °F)
Rankine	17-21	Toluene	750
Brayton	22-28	HeXe	1500

require solar energy concentrators, heat receivers and storage systems, heat engines driving alternators to generate electric power, and space radiators to reject waste heat.

Concentrator technology, based on ground systems, is reasonably well known and understood. The application of this technology to zero gravity and the environments of space are the issue. Few concentrators have been built for space applications and none have flown. For the space station, size (in the range of 40 to 45 feet in diameter per unit) is another issue that must be addressed. At this time, the technical issues relate to: the accuracy to which the surface can be made (focus is important to concentrator performance), reflective coating durability (affects concentrator performance and maintenance requirements), and system design (for transport, assembly, and maintainability). Contracts for detailed work in these areas are in process. The effort is to be directed at analytical and experimental work as well as trade-off analyses.

Concentrators are to be built and delivered to NASA LeRC for testing. (This is part of the process of keeping the NASA team technically strong and actively contributing to the space station program.) The collector design is targeted to provide energy for continuous operation of a 20- to 25 kW_e-engine in low-earth orbit.

The Department of Defense (DOD) has had experience with this type of device. It would be worthwhile to contact DOD and their contractor(s) to benefit from their experience. (Dr. M. Steinberg of Lockheed is one contact.)

There is a fair amount of experience and data on receiver design and operation from ground-based systems, but there is relatively little experience with thermal energy storage. A valuable feature of the solar thermodynamic system is that it allows elimination of the electric storage cells required by photovoltaic systems for dark-side orbital operations.

The solar energy receiver and thermal storage systems are critical technology development items. The latter is especially critical and will be given most of the attention. The more difficult technical issues for receivers and storage units relate to such matters as fabrication, thermal cycling and related fatigue, corrosion, and heat flux matching.

Most of the technology development contracts are in place and a few remain to be processed. The plan is to have the contractor(s) provide hardware compatible with the model solar energy collector for testing at LeRC.

There is significant ground experience with heat engines that is transferable to spaceborne systems. Organic Rankine systems have collectively accumulated some 10⁸ hours of terrestrial operations. A Brayton system, designed for space operations, has been run in ground tests for some 38,000 hours. This work provides a sound technology base for space station application of such heat engines.

Control of two-phase fluid for Organic Rankine systems (e.g., condensing and pumping of toluene) is an issue. Such phenomena need to be examined in zero gravity. It is possible that high pressure operation could ease the two-phase problem through elimination of the phase shift. Plans include the development and testing of a thermal management device and of a working fluid dynamics stability rig (for on- and off-design conditions) over long periods of time. This work should result in useful data for design of controls, operational procedures and codes, and the definition of performance and power relationships.

The choice of Rankine or Brayton will come out of trade-off analyses. At this point, the data base is not adequate to predict which system is best.

Radiator technology is lacking, although some terrestrial data exist on a pumped-loop radiator for a Brayton system. Such a system was tested for some 2,500 hours in simulated low-earth orbit conditions. However, no moderate temperature (heat rejection temperatures of 250°F to 300°F) radiators have been operated in space. Heat pipes are of interest and have advantages in both reliability and weight. Heat pipe design issues include adapting heat pipes to solar thermodynamic systems and construction for space deployment or erection.

The program plan includes technology development work and analyses of heat pipe radiator application to solar thermodynamic electric power generating systems. Also included are design, fabrication, and test of a full-scale radiator segment.

Because of how these activities are scheduled, the data will be developed later than desired. However, there is reasonable confidence that the data for Phase C/D decision making will be timely enough. The program managers do not believe that additional funding could be applied effectively to accelerate the program.

The Office of Aeronautics and Space Technology (OAST) is supporting longer term solar thermodynamic research and advanced technology (some \$3.5 million in FY 1985). Much of this work is directed at the Stirling system. The Stirling work at LeRC is part of the SP-100 space power unit program, supported jointly by DOD, the Department of Energy, and NASA. LeRC, which has the major NASA share of this activity, is keeping the work for the space station closely coupled with that for the SP-100 program. The OAST program also supports work on advanced photovoltaic systems that include higher temperature solar energy conversion systems and associated electric storage cells.

The program philosophy is to use proven technology, but to use advanced technology where there is high confidence that it can be made to work on the planned schedule with acceptable cost. The division of effort for the solar thermodynamic system program for the period of FY 1985 through 1987 (total funding, \$14.1 million) is: concentrator, 36 percent; receiver, 45 percent; radiator, 12 percent; and two-phase

fluid management, 7 percent. Concentrators and receivers are to get 81 percent of the funding. It was noted that DOD is active in these areas and that NASA, if it hasn't, should review this activity, its technical status, and applicability.

In-house Testing--Richard Puthoff, NASA LeRC In-house activity is part of the plan to build and maintain a strong interactive technical program role at LeRC with the contractors, Level B, and the other Level C space station program offices. The role entails, among other things, design and analyses, program management of the Phase B contracts (work package 4), management of advanced (technology) development contracts (the \$14.1 million program), definition and synthesis of the reference solar thermodynamic electric power generating system, and conduct of the in-house test program. Included is maintenance of a reference data book system and its update.

The in-house program will include testing of available system components as well as advanced system components and will end with tests of concentrator-receiver assemblies, as was noted. Required in-space tests are also included. Existing system hardware comes from 1960-1970 programs. The hardware is being brought out of storage and refurbished. The test program will cover, among other things, alternator, power management and distribution system (PMAD) interactions, single and double unit operation, AC/DC resonant converters, and system intergration for photovoltaic and thermodynamic power sources. The program will also include testing to establish design requirements for alternator voltage and speed control for a high-frequency (20 kHz) PMAD system.

A 20-foot diameter concentrator will be used to develop optical test and evaluation techniques. Surface characteristics, as has been noted, are important especially for high temperature systems because efficiency is a function of the trueness and reflectivity of the surface.

Ground testing of solar energy concentrators will not resolve all in-space design and performance issues, but will yield some assessment of system sensitivity to design and operating environments. Attention will have to be given to the issue of in-space testing of the selected system(s).

The concentrator test program will include examination of the effects of atomic oxygen on reflectors as well as the compatability of receiver materials with the salts used for energy storage.

This work is to be essentially complete by early 1987, prior to Phase C/D authority to proceed (ATP), with the exception of some receiver materials' compatibility testing and follow-on generator/PMAD tests.

The hardware for the advanced technology development component tests will not be available until 1987. This part of the program is to

include: radiator (heat pipe) thermal vacuum performance and operational tests; concentrator segment optics to obtain data on surface errors and optical properties of a full-size concentrator segment (the segment design and tests will account for in-space characteristics and behavior to the degree possible); receiver thermal/vacuum tests to obtain verification data on the selected receiver/thermal energy storage system; and concentrator/receiver test for solar heat flux profile examination. The latter work will include separate as well as integrated tests.

Some of the testing will involve simulation of the operating environments of space, which raises a question about the characteristics of this environment. Though not a serious issue at this time, the matter will continue to be examined to help define the test protocol. For example, there will be a need to know the vibration levels (g's) of the station, not only for electric power system design and the effects of power generation system operation on the station, but also for operational use of the station by commercial, technical, and scientific clients.

Present planning calls for this work to be completed by mid-1988 with the exception of projected concentrator/receiver tests.

LeRC will be prepared to support Phase C/D testing, including full-size tests of the receiver/engine and of the concentrator if required. It is anticipated that this testing (design and off-design) will involve prototype hardware. The test facility would be a vacuum chamber capable of simulating the thermal environment, and the system would operate with the PMAD system. It can be expected that part of the Phase C/D tests would be directed at evaluating the optical characteristics of a full-scale, fully deployed concentrator.

Contractor Phase B Activity--Jerry Friefeld, Rocketdyne and James Hieatt, TRW The contractor briefings included proprietary data and are considered privileged by the LeRC program managers. Therefore, these presentations are not included in this report, and the following summaries are general. Representatives of one contractor left the meeting when the other contractor's presentation was made.

The Rocketdyne team includes Garrett, Sundstrand, Harris, Ford Aerospace, Ling Tempco Voight, Life Systems Inc., and United Technologies. The TRW team includes General Electric, Grumman Aerospace Corporation, Life Systems Inc., United Technologies, General Dynamics Corporation, Mechanical Technologies Inc., and Perkin-Elmer.

During the Rocketdyne presentation, the solar power cycle and representative integrated power generating systems for the space station were discussed. The technology issues and their criticality were reviewed. Some of the specific technology development tasks being undertaken by the Rocketdyne team and details of design approaches were also reviewed. Planned subscale tests of integrated systems were described. NASA contracted and company-funded independent research

and development activities are being integrated to form an advanced technology development effort.

The TRW study includes some 20 point-designs of electric power generating systems (photovoltaic, Rankine, Brayton, Stirling, and nuclear) for the space station (IOC and growth) and platforms. Included are hybrids of the power generating systems. The study has progressed enough to allow comparisons of the point designs and preliminary recommendations and conclusions. A plan being developed for advanced technology development work encompasses the major subsystems: collectors, receiver storage, heat engine, and alternator and thermal control. The key issues and actions to be addressed have been identified.

Dynamic disturbance of the space station due to the rotating power generating unit was a point of interest to the panel. It was noted that the dynamic response question has been examined and is assessed to be of little significance, but will receive additional attention. Another point of interest was whether the space station radiators could be used for electric power system heat rejection. This approach to thermal control was considered but not pursued due to the problem of "long-distance" fluid handling and fluid transfer across moving joints.

Representative power modules, system growth paths, and scarring for IOC were described. Also described were advanced technology development projects that TRW and its subcontractors are pursuing with their independent research and development funds. The results of this work will be incorporated in their Phase B effort.

Level B Perspective--Dwayne Weary, NASA Johnson Space Center Program
Level B management is fully committed to a comprehensive, timely evaluation of solar thermodynamic electric power generating options for IOC and the growth station. Power generation, a key issue, has a designated manager and is integrated into the engineering master schedule (EMS) for the space station.

The funding for the advanced development program is firm and is being focused on collectors, receivers, and thermal storage. The Level B office is very pleased with the LeRC effort.

At Level B, systems engineering and integration tasks are being pursued to provide an independent look at electric power generation. This work, taking place at the Langley Research Center and Johnson Space Center, addresses comparisons of photovoltaic and thermodynamic systems, change over and scarring, cost effectiveness, and systems integration with the space station.

The Level B office, itself, has a series of studies under way addressing near- and long-term benefits, power requirement growth, quantification of schedule and cost risk, and technology development requirements. In the process, the office is focusing on developing representative implementation plans covering: thermodynamics for IOC,

photovoltaic to thermodynamic changeover for growth, and a long-range growth plan including a nuclear power option. The intent of this effort is to narrow the electric power options as quickly as possible. The power system decision has significant impact on other design features of the station and is important from cost- and risk-reduction considerations.

The power choice implications are also being examined in terms of actions required for each Phase B contractor work package. Activity to involve the international partners in the space station electric power generation program has started.

Hardware Examination The panel made a brief laboratory facilities visit to see and discuss work on an electric power transfer ring (360° of rotation); a model of a reflector to be used for development of optical measurement techniques; a Brayton power generator test set-up; and a control system simulator for power management.

3

Summary Comments

The panel is very pleased with the progress made this past year in organizing and initiating work on the electric power generating system options for the space station. The attitude and action at LeRC and within the Space Station Office, Level B, is appropriate and commendable. Earlier panel commentary on program issues appears to have been fully taken into consideration.

There was some concern that the Stirling system was not receiving adequate technology development attention, in light of its potential for application in the longer term. At present, this is not a concern because work is under way (NASA, DOD, DOE) in connection with the SP-100 system and is proceeding well. The target power level for the SP-100 Stirling system is 25 kW. A test article has been operated at 3kW and will soon be tested at higher powers.

Discussion of the basis for making the electric power generating system decision raised a question as to whether selection criteria had been developed. One view was that it was not too early to begin to identify these criteria. A corollary question was the degree of specificity. The general position taken by the panel was that the matter needs attention, but that the criteria should not be overly specific. Too much specificity could result in overly conservative decisions.

The feeling was that the Stirling system should be seriously considered for future growth and that OAST's and related programs should be examined in some depth in the future.

An additional point of potential concern is the availability of the Shuttle for critical component technology development. The Shuttle manifest is projected to be full in the period of space station subsystem development, and early planning for the use of the Shuttle for system development tests is mandatory.

The following responses to the questions in the panel's task statement are based on the panel's discussion:

- Coverage of critical technology? The program plans identify and address the major issues and technology development needs adequately.
- Are the milestones realistic and compatible with those of the space station? Yes. However, the schedules generally have little slack, and the work will require careful planning. The program managers recognize this fact.
- Are the technical approaches and analyses planned likely to lead to clear decisions in time? This goal is believed to be achievable. But, it appears desirable to begin to address the matter of selection criteria, which should not be too limiting and result, therefore, in an overly conservative choice.
- Are preparations adequate for accommodating a solar thermodynamic electric power generation system should such a system be selected? Yes. The program plan is believed to cover this well.

In summary, the panel believes that a sensible program has been defined; that the program structure is sound; that good progress has been made; and that there is a good "can do" attitude.

APPENDIX A

Meeting Agenda

SPACE STATION ENGINEERING AND TECHNOLOGY DEVELOPMENT
Panel on Solar Thermodynamics R&T MeetingAGENDA

July 31, 1985
 NASA Lewis Research Center
 Cleveland, Ohio

Welcome	J. Klineberg, Deputy Director, LeRC
Overview of NASA-Lewis Solar Dynamic Program	R. Thomas, Director Space Station Systems
Status of Program	D. Namkoong, Technical Manager, Solar Dynamics
NASA Lewis In-house Testing	R. Puthoff, Power System Engineering Division
Rocketdyne	J. Friefeld, Associate Program Director of Advanced Development
TRW	J. Heatt, Deputy Project Manager
Level B Perspective	D. Weary, Manager Energy Systems Office, JSC
Solar Dynamic Exhibit	
Discussion and Action	Panel

APPENDIX B

Briefings

<u>Welcome</u>	(No graphics)
J. Klineberg, NASA Lewis Research Center	
<u>Overview of NASA-Lewis Solar Dynamics Program</u>21
R. Thomas, NASA Lewis Research Center	
<u>Status of Program</u>33
D. Namkoong, NASA Lewis Research Center	
<u>In-house Testing</u>47
R. Puthoff, NASA Lewis Research Center	
<u>Contractor Phase B Activity</u>	(Graphics not included)
J. Friefeld, Rocketdyne	
J. Hieatt, TRW	
<u>Level B Perspective</u>71
D. Weary, NASA Johnson Space Center	

SPACE STATION SYSTEMS

NASA

Lewis Research Center

5474W

SPACE STATION SYSTEMS DIRECTORATE

SOLAR DYNAMIC POWER SYSTEMS

BRIEFING FOR THE ASEB

BY

RONALD L. THOMAS

JULY 31, 1985

SPACE STATION SYSTEMS DIRECTORATE

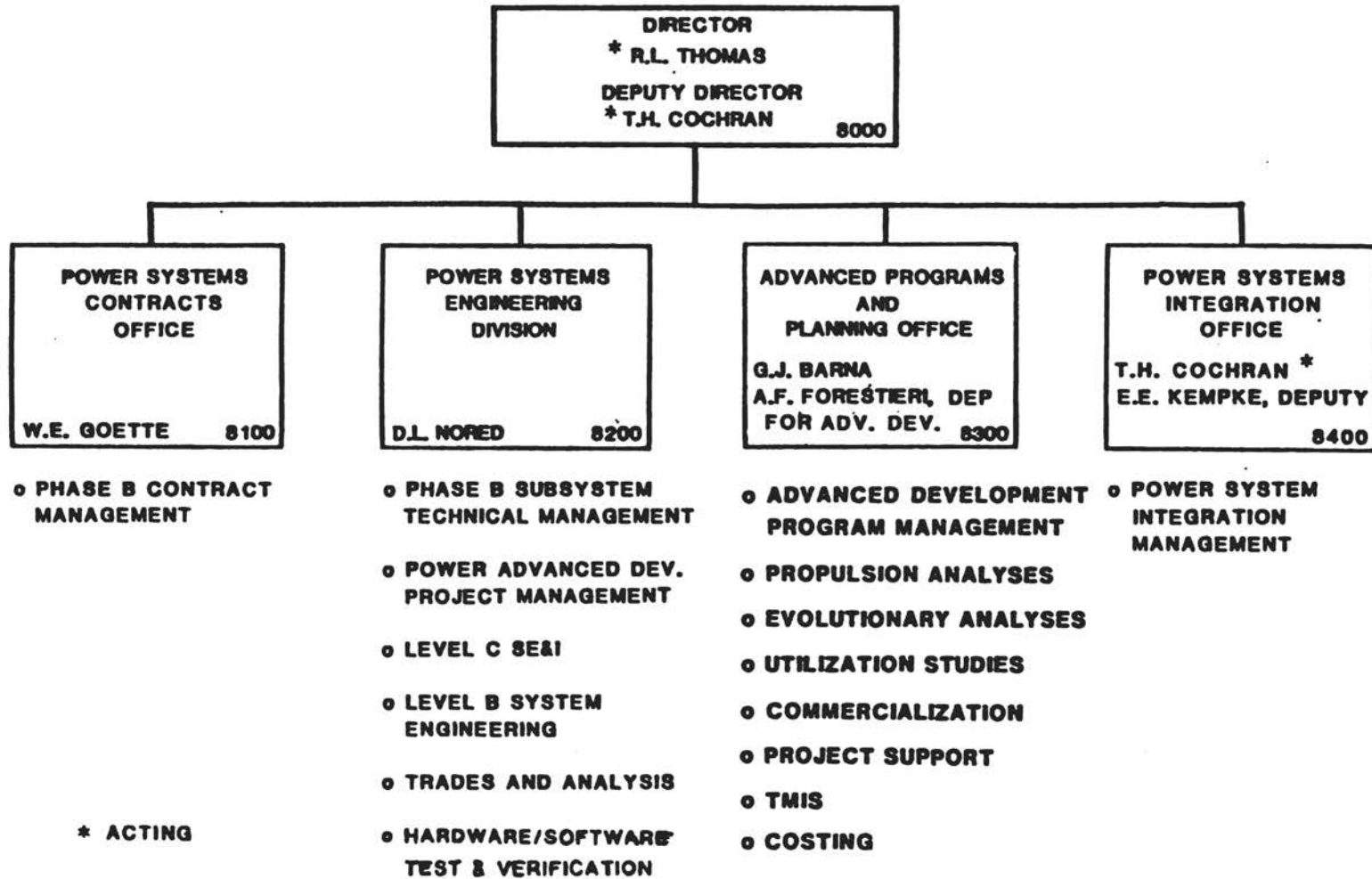

ADVANCED PROGRAMS AND PLANNING OFFICE

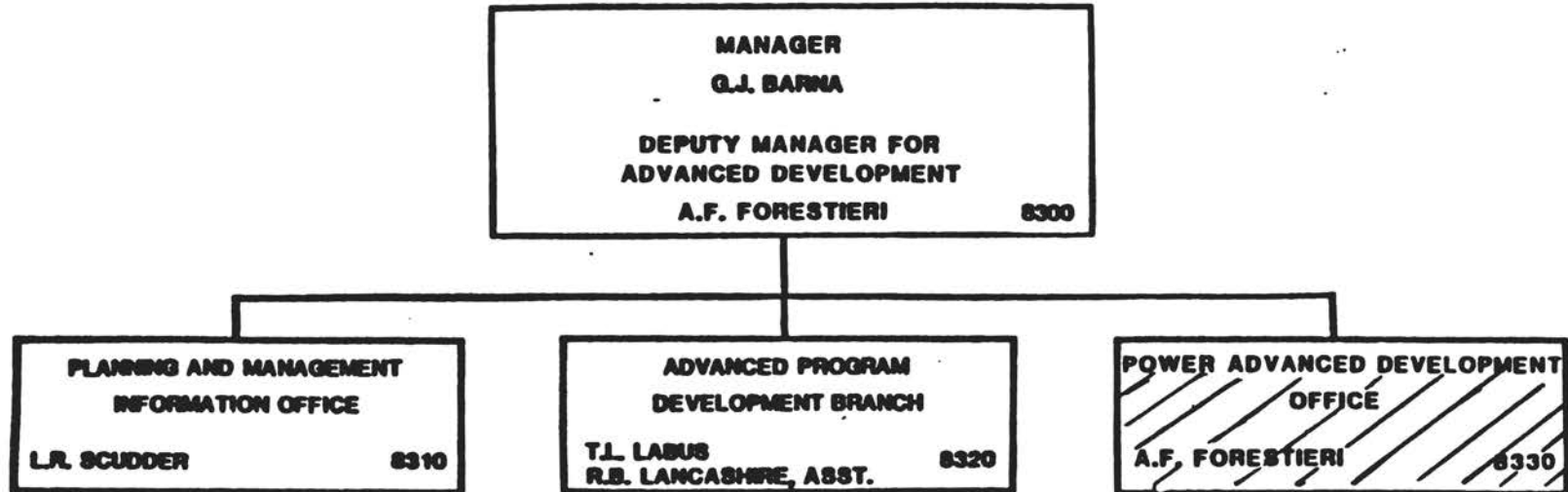

POWER SYSTEM ENGINEERING DIVISION

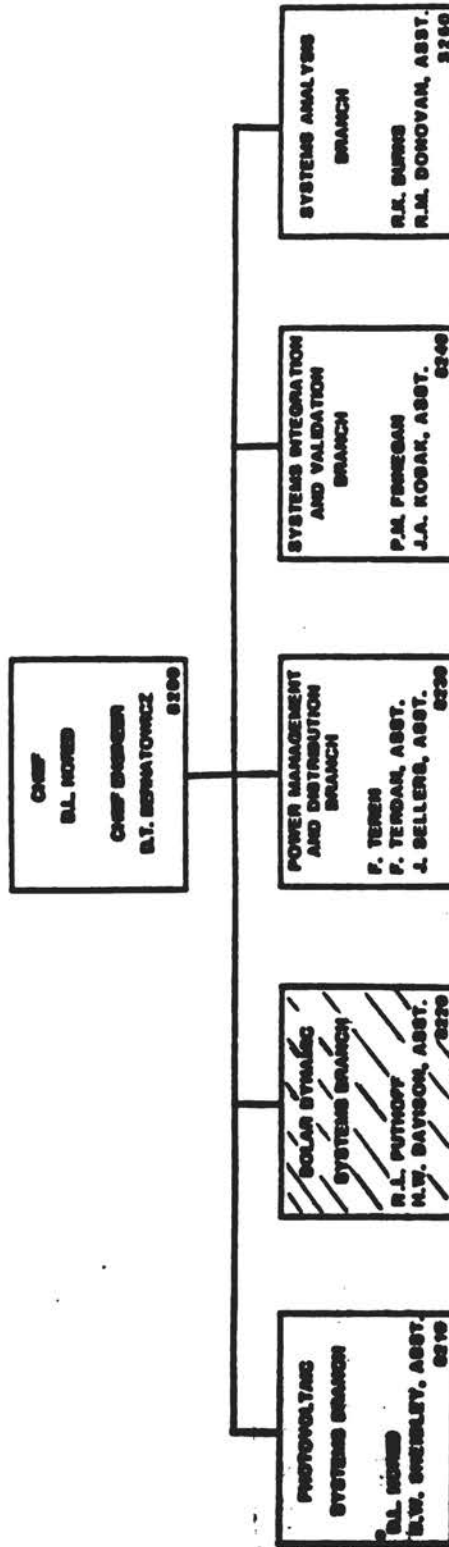

*ACTING

SPACE STATION SYSTEMS

Lewis Research Center

NASA

5474W

SPACE STATION SYSTEMS DIRECTORATE

SOLAR DYNAMIC POWER SYSTEMS

DEFINITION PROGRAM

- TRADE STUDIES AND ANALYSES
- ADVANCED TECHNOLOGY DEVELOPMENT
- DEVELOPMENT PHASE PLANNING

SPACE STATION SYSTEMS

Lewis Research Center

NASA

5474W

SPACE STATION SYSTEMS DIRECTORATE

SOLAR DYNAMIC POWER SYSTEMS

TRADE STUDIES AND ANALYSES

OBJECTIVE

- ASSESSMENT OF OPTIONS AT SYSTEMS AND SUBSYSTEMS LEVEL
 - PHOTOVOLTAIC VS. SOLAR DYNAMIC
 - BRAYTON CYCLE VS. ORGANIC RANKINE CYCLE
 - HIGH VOLTAGE DC VS. AC
- > EXAMPLES

APPROACH

- CONDUCTED UNDER CONTRACT (PHASE B) AND IN-HOUSE
- INTERACTIONS WITH OTHER WORK PACKAGES AND LEVEL B

RESULTS

- CAPABILITY VS. COST
- OPTION CHARACTERISTICS AND BENEFITS
- LAUNCH AND ASSEMBLY SCENARIOS
- GROWTH PATHS
- TECHNOLOGY REQUIREMENTS

SPACE STATION SYSTEMS

Lewis Research Center

NASA

5474W

SPACE STATION SYSTEMS DIRECTORATE

SOLAR DYNAMIC POWER SYSTEMS

ADVANCED TECHNOLOGY DEVELOPMENT

OBJECTIVE

- DEVELOP TECHNOLOGY TO A MATURITY LEVEL THAT PERMITS QUANTIFICATION OF THE COST AND SCHEDULE RISK OF SYSTEM DEVELOPMENT

APPROACH

- CONDUCTED IN-HOUSE, ON CONTRACT AND WITHIN THE PHASE B CONTRACTS
- CONCEPTUAL DESIGNS OF SPACE STATION SYSTEMS
- COMPONENT DESIGN, DEVELOPMENT AND TESTING
- SUBSYSTEM LEVEL TESTING WHERE POSSIBLE

RESULTS

- PERFORMANCE ENVELOPES
- OPERATIONAL CHARACTERISTICS

SPACE STATION SYSTEMS

Lewis Research Center



5474W

SPACE STATION SYSTEMS DIRECTORATE

SOLAR DYNAMIC POWER SYSTEMS

DEVELOPMENT PHASE PLANNING

- **WORK BREAKDOWN STRUCTURE**
- **DDT&E COST ESTIMATES**
- **PROCUREMENT OPTIONS**
- **VERIFICATION AND TEST PLANNING**
 - **COMPONENT AND SUBSYSTEM LEVEL TESTING**
 - **GROUND SYSTEM LEVEL DEMONSTRATIONS**
 - **IN FLIGHT EXPERIMENTS**

SPACE STATION SYSTEMS

Lewis Research Center



SPACE STATION PROGRAM SCHEDULE

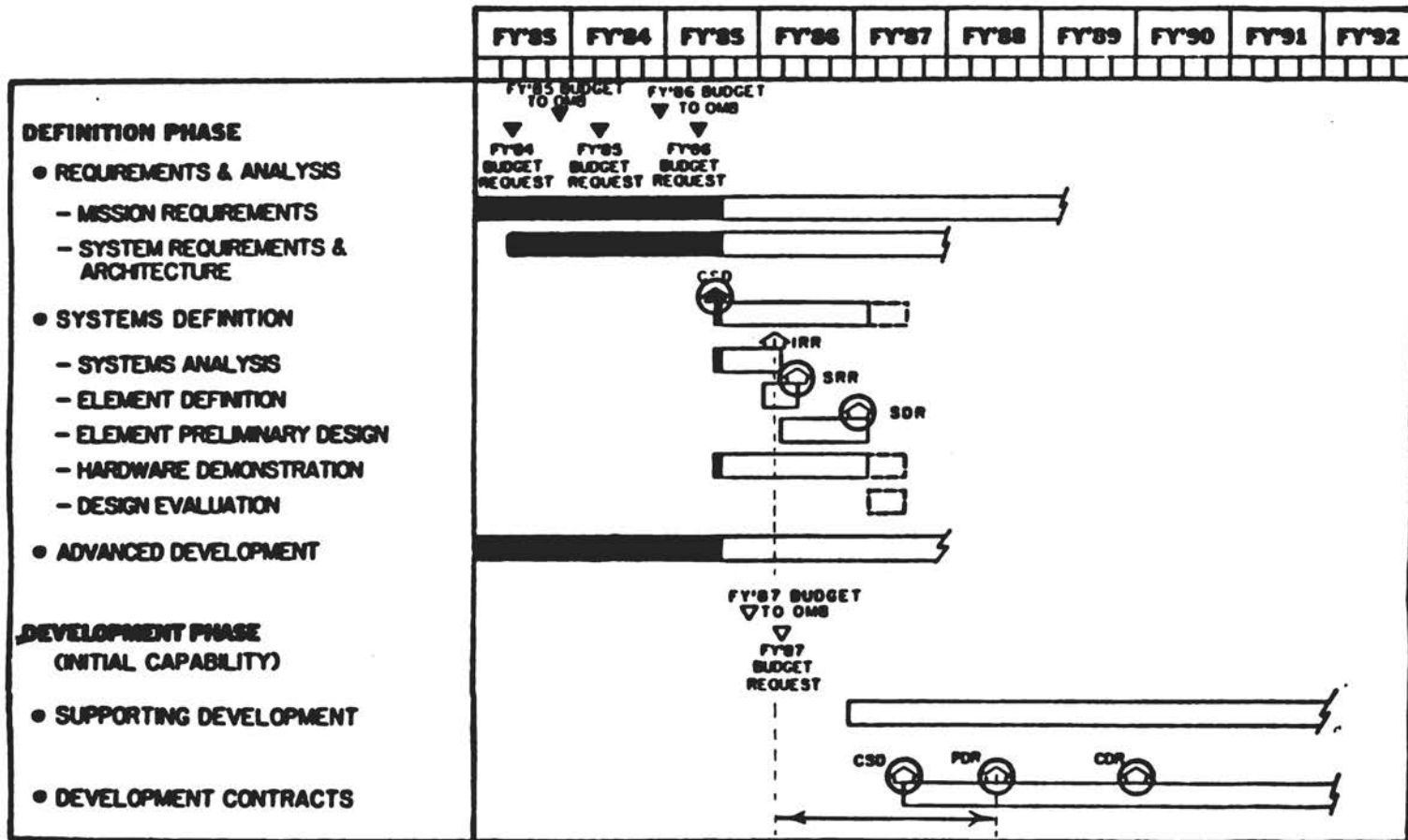

DECISION ENVELOPE

SPACE STATION SYSTEMS

Lewis Research Center



5474W

SPACE STATION SYSTEMS DIRECTORATE

SOLAR DYNAMIC POWER SYSTEMS

ADVANCED TECHNOLOGY DEVELOPMENT RESOURCES

FY 85

NASA POWER

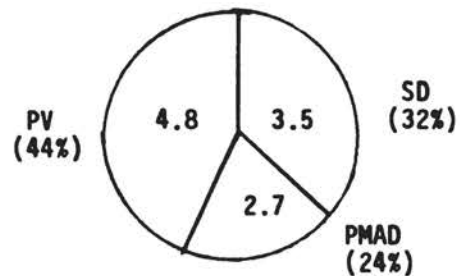

11 MILLION

LERC POWER

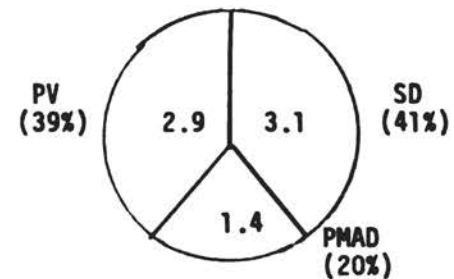

7.4 MILLION

FY 86

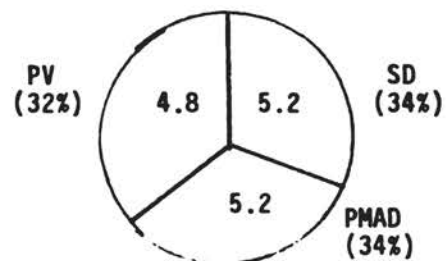

15 MILLION

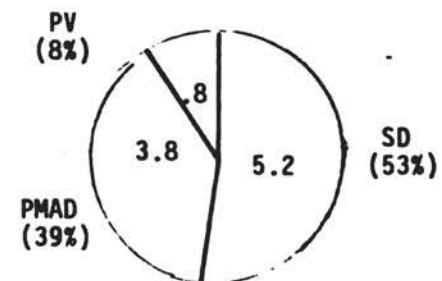

9.8 MILLION

PHASE B CONTRACTORS SPENDING IN EXCESS OF \$5.5 MILLION OVER DURATION OF CONTRACTS

SPACE STATION SYSTEMS

NASA

Lewis Research Center

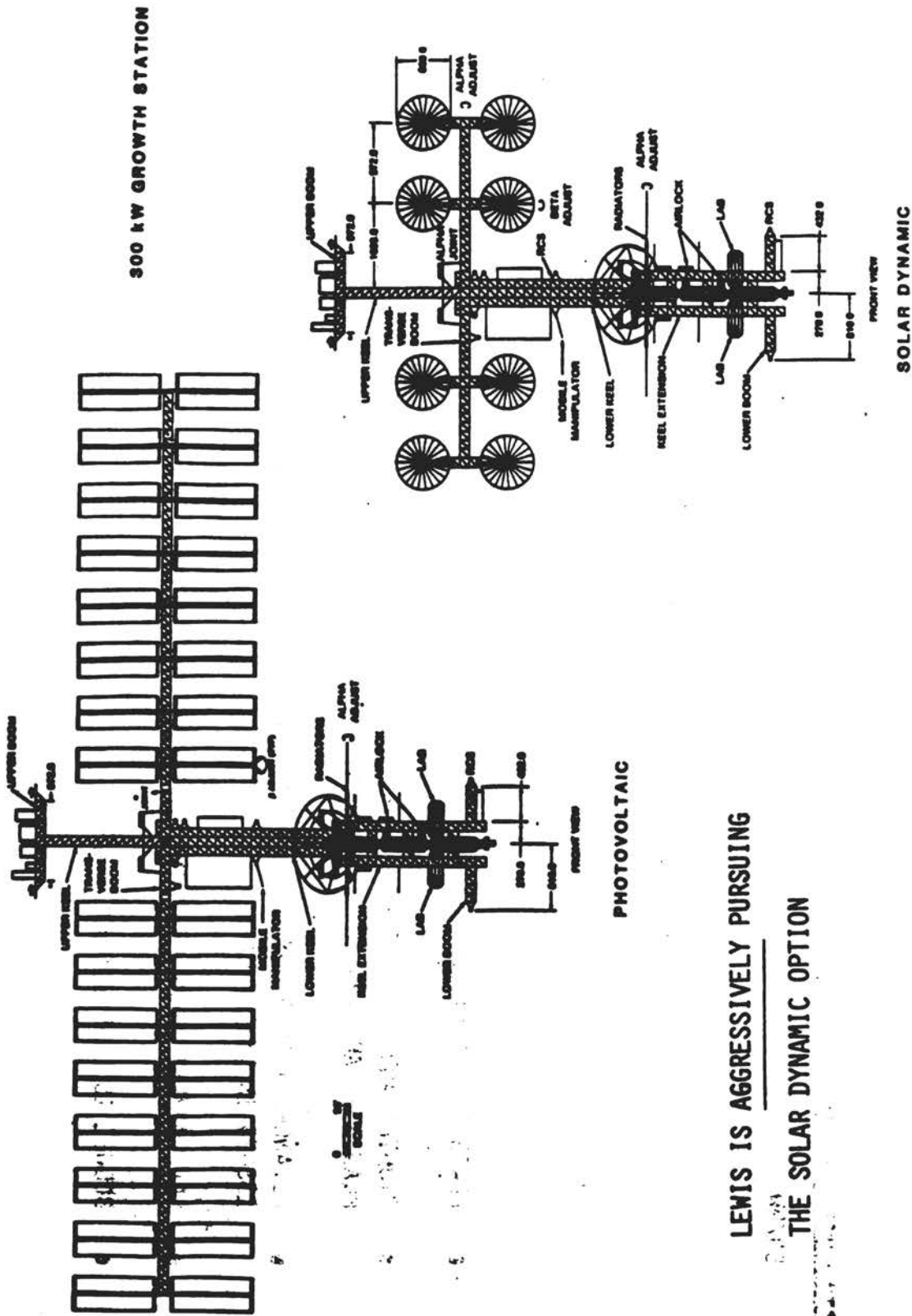

LEWIS IS AGGRESSIVELY PURSUING
THE SOLAR DYNAMIC OPTION

SPACE STATION SYSTEMS

Lewis Research Center

NASA

5474W

SPACE STATION SYSTEMS DIRECTORATE

SOLAR DYNAMIC POWER SYSTEMS

SUMMARY

- LEWIS IS ORGANIZED TO AGRESSIVELY PURSUE SOLAR DYNAMIC OPTION
- STUDIES AND ANALYSES ARE IN PLACE TO DRIVE OUT DATA REQUIRED TO JUSTIFY AND PLAN A SOLAR DYNAMIC DEVELOPMENT PROGRAM
- ADVANCED TECHNOLOGY DEVELOPMENT PROGRAM STRUCTURED TO ADDRESS AND RESOLVE KEY ISSUES IN TIMELY MANNER
- DEVELOPMENT PHASE PLANNING IS TAKING INTO ACCOUNT SOLAR DYNAMIC REQUIREMENTS
- BUDGET IS LEAN BUT ADEQUATE

SPACE STATION SYSTEMS

POWER SYSTEMS ENGINEERING DIVISION

SOLAR DYNAMIC SYSTEM CONCEPT

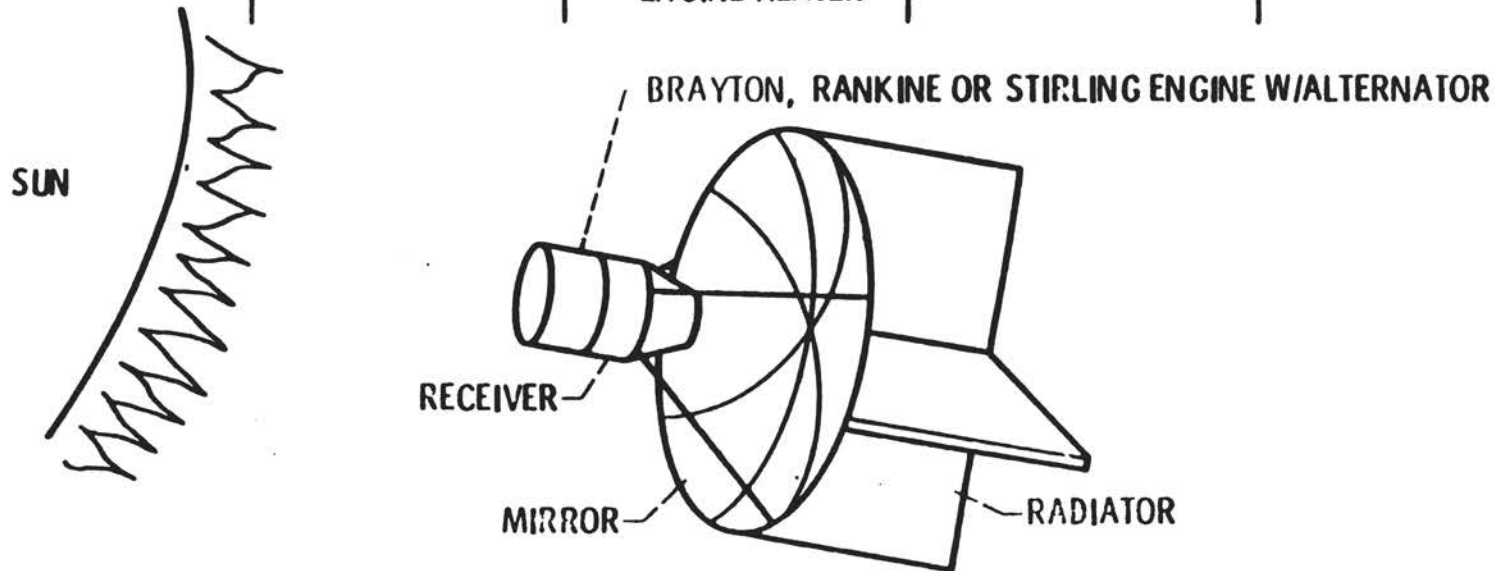
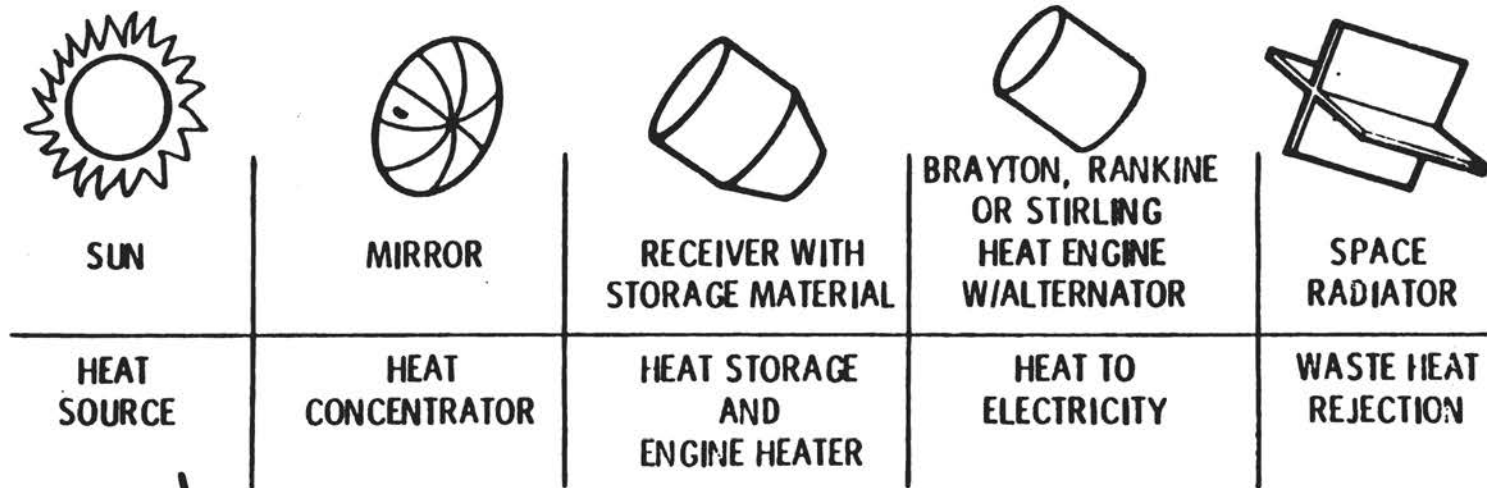

SPACE STATION SYSTEMS

POWER SYSTEMS ENGINEERING DIVISION

Lowie Research Center



SOLAR BRAYTON CYCLE

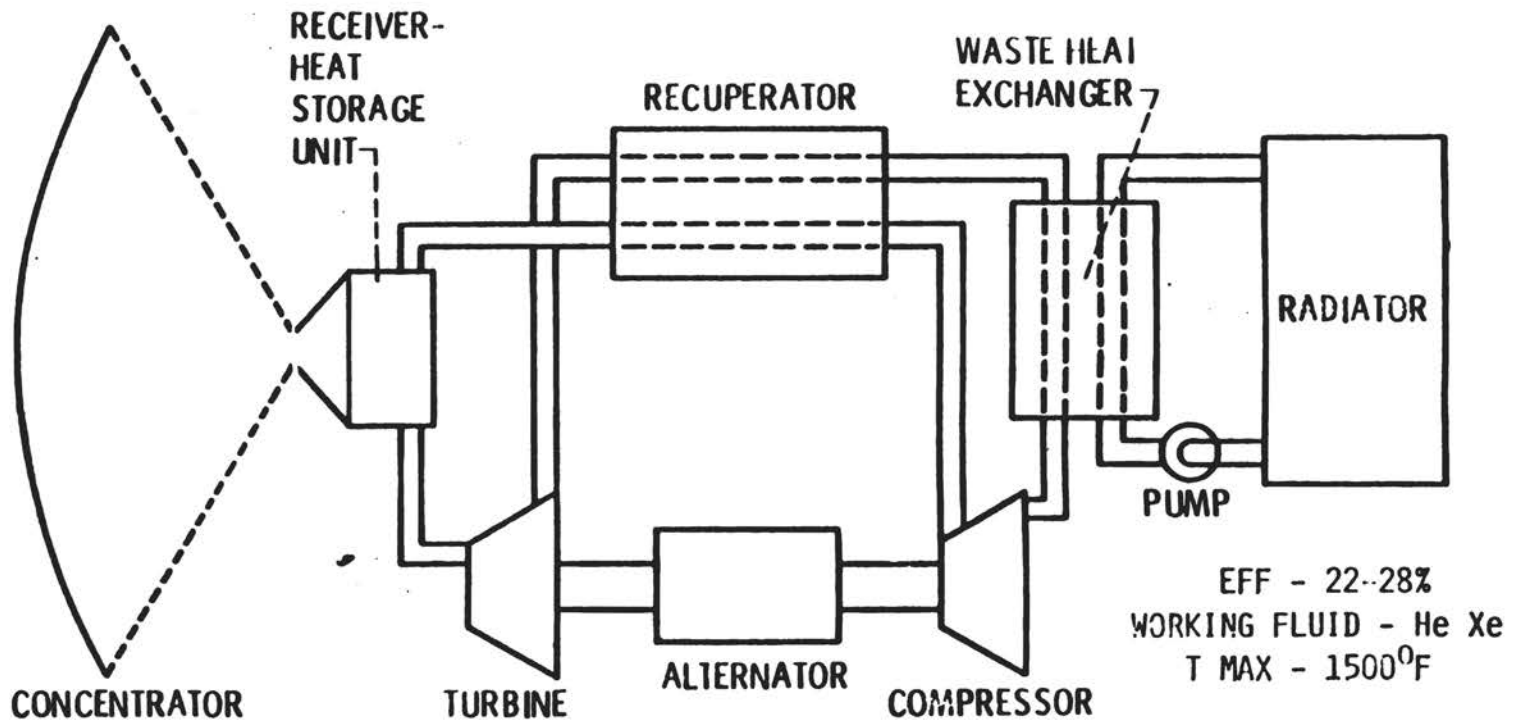

SPACE STATION SYSTEMS

POWER SYSTEMS ENGINEERING DIVISION

Lewis Research Center

NASA

SOLAR ORGANIC RANKINE CYCLE

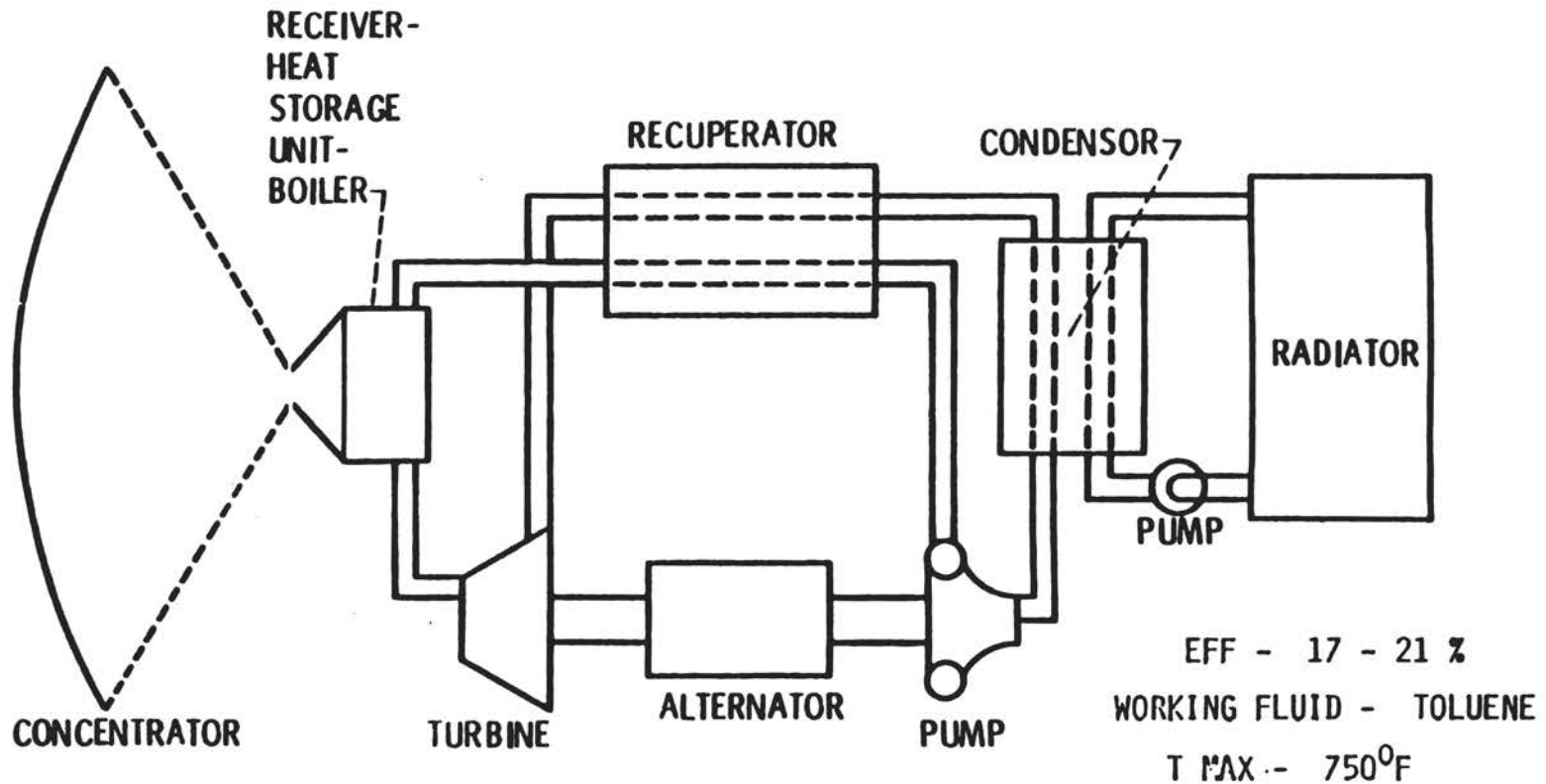

SPACE STATION SYSTEMS

POWER SYSTEMS ENGINEERING DIVISION

Lewis Research Center

NASA

CONCENTRATOR

STATE OF THE ART

- A FEW SPACE CONCENTRATORS BUILT, BUT NOT FLOWN. NEW DESIGNS NEEDED FOR NEW REQUIREMENTS
- TERRESTRIAL CONCENTRATORS NOT SUITABLE FOR SPACE, BUT DO PROVIDE INFORMATION ON
 - DESIGN AND FAB METHODS
 - TEST AND MEASUREMENT METHODS
 - COATINGS
 - OPERATING EXPERIENCE
- LARGE SPACE ANTENNA TECHNOLOGY USEFUL

TECHNICAL ISSUES

- ACCURACY
- MANUFACTURING/ASSEMBLY
 - FABRICABILITY
 - STOWABILITY
 - ERECTABILITY
- REFLECTIVE COATINGS DURABILITY

SPACE STATION SYSTEMS

ADVANCED PROGRAMS & PLANNING OFFICE

Lewis Research Center

NASA

SOLAR DYNAMIC CONCENTRATOR TECHNOLOGY

OBJECTIVE: IDENTIFY TECHNOLOGY CONCEPTS FOR CONCENTRATORS FOR THE SOLAR DYNAMIC POWER SYSTEM AND EVALUATE THESE CONCEPTS THROUGH ANALYTICAL AND EXPERIMENTAL MEANS.

DESCRIPTION: GENERATE CONCENTRATOR CONCEPTUAL DESIGNS, PERFORM TRADEOFF STUDIES, IDENTIFY AND TEST MATERIALS APPLICABLE FOR USE IN SPACE, PERFORM DETAILED ENGINEERING DESIGNS, BUILD AND TEST ONE CONCENTRATOR AND DELIVER IT TO NASA.

CENTER: LERC

EXPECTED RESULTS: A GROUND TESTED CONCENTRATOR CAPABLE OF DELIVERY SUFFICIENT TO THE RECEIVER FOR A 20-25 KWe ENGINE TO OPERATE CONTINUOUSLY IN A LEO.

SPACE STATION SYSTEMS

POWER SYSTEMS ENGINEERING DIVISION

Lewis Research Center

NASA

RECEIVER/THERMAL STORAGE

STATE OF THE ART

- **SOME GROUND TESTS OF ELEMENTS OF SPACE HEAT RECEIVERS**
- **SOME TERRESTRIAL HEAT RECEIVER EXPERIENCE, GENERALLY WITHOUT HEAT STORAGE. PROVIDES INFO ON**
 - **DESIGN AND FAB METHODS**
 - **TEST AND MEASUREMENT METHODS**
 - **OPERATING EXPERIENCE**
- **DATA EXISTS, SOME EXTENSIVE, ON PHASE CHANGE STORAGE MATERIALS AND CONTAINMENT MATERIALS**

TECHNICAL ISSUES

- **A TOUGH ENGINEERING DESIGN INVOLVING**
 - **FABRICABILITY**
 - **CORROSION**
 - **THERMAL CYCLING/FATIGUE**
 - **VOLUME CHANGE OF SALT**
 - **HEAT FLUX MATCHING**

SPACE STATION SYSTEMS

ADVANCED PROGRAMS & PLANNING OFFICE

Lewis Research Center

NASA

SOLAR DYNAMIC HEAT RECEIVER TECHNOLOGY

OBJECTIVE: TO DEVELOP, DEMONSTRATE, AND ESTABLISH THE FEASIBILITY OF A HEAT RECEIVER AND THERMAL ENERGY STORAGE DEVICE FOR A SOLAR DYNAMIC POWER SYSTEM FOR THE SPACE STATION.

DESCRIPTION: UNDER CONTRACT(S) PRODUCE CONCEPTUAL DESIGNS, PERFORM TRADE STUDIES, CONDUCT DETAILED DESIGNS, DEVELOP REQUIRED TOOLING, FABRICATION, AND VERIFICATION TESTING OF A HEAT RECEIVER AND THERMAL STORAGE SYSTEM TO PROVIDE ENERGY FOR A 20-25 KWE ENGINE ON A CONTINUOUS BASIS IN A LEO.

39

CENTER: LERC

EXPECTED RESULTS: A HEAT RECEIVER AND THERMAL ENERGY SOURCE TESTED ON THE GROUND WITH THE CAPABILITY OF PROVIDING ENERGY TO OPERATE A 20-25 KWE ENGINE.

SPACE STATION SYSTEMS

POWER SYSTEMS ENGINEERING DIVISION

Lewis Research Center

NASA

POWER CONVERSION SUBSYSTEM (HEAT ENGINE)

STATE OF THE ART

ORGANIC RANKINE

EXTENSIVE TECHNOLOGY BASE FOR SPACE AND TERRESTRIAL APPLICATIONS
(E.G., 10^8 HRS. TERR. OPER. EXPER.)

BRAYTON

EXTENSIVE TECHNOLOGY BASE FOR SPACE AND TERRESTRIAL APPLICATIONS
(E.G., 38,000 HRS. GROUND TEST OF SPACE UNIT)

TECHNICAL ISSUES

ORGANIC RANKINE: TOLUENE TEMP. LIMIT
TWO-PHASE FLUID CONTROL

SPACE STATION SYSTEMS

ADVANCED PROGRAMS & PLANNING OFFICE

Lewis Research Center

NASA

SOLAR DYNAMIC POWER CONVERSION SUBSYSTEM TESTS

OBJECTIVE: DEMONSTRATE AN EFFECTIVE AND EFFICIENT ORC THERMAL MANAGEMENT SYSTEM FOR SS DESIGN AND OFF-DESIGN CONDITIONS AND DETERMINE LONG TERM FLUID STABILITY.

DESCRIPTION: DESIGN, FABRICATE, TEST, AND EVALUATE THE THERMAL MANAGEMENT DEVICE PERFORMANCE AND RESULTING ORC ENHANCED PERFORMANCE. DESIGN, FABRICATE, AND TEST A WORKING FLUID DYNAMIC STABILITY RIG OPERATING CONTINUOUSLY FOR LONG TIMES.

41

CENTER: LERC

EXPECTED RESULTS: DESIGN SPECIFICATIONS, OPERATIONAL PROCEDURES, METHODS OF THERMAL AND FLUID STABILITY CONTROL, CODES, AND PERFORMANCE VERSUS SYSTEM POWER PREDICTIONS.

SPACE STATION SYSTEMS

POWER SYSTEMS ENGINEERING DIVISION

Lewis Research Center

NASA

RADIATOR

STATE OF THE ART

- NO MODERATE TEMPERATURE RADIATORS HAVE BEEN FLOWN IN SPACE
- A PUMPED LOOP RADIATOR FOR BRAYTON CYCLE WAS TESTED SUCCESSFULLY FOR 2500 hrs UNDER SIMULATED LEO CONDITIONS
- HEAT PIPES OFFER ADVANTAGES IN RELIABILITY AND WEIGHT

TECHNICAL ISSUES

- HEAT PIPE DESIGNS MUST BE ADAPTED TO SOLAR DYNAMIC SYSTEM REQUIREMENTS AND PROVEN
- DEPLOYABILITY/ERECTABILITY MUST BE ADDRESSED

SPACE STATION SYSTEMS

POWER SYSTEMS ENGINEERING DIVISION

Lewis Research Center

NASA

SOLAR DYNAMIC HEAT REJECTION TECHNOLOGY

UPN 482-56-87

OBJECTIVE: DEMONSTRATE THE TECHNOLOGY READINESS OF THE WASTE HEAT REJECTION SUBSYSTEM REQUIRED FOR THE SOLAR DYNAMIC POWER CONVERSION SYSTEMS THAT ARE CANDIDATES FOR THE IOC SPACE STATION ELECTRICAL POWER SYSTEM.

SCOPE: FUND A TASK ORDER CONTRACT THAT WILL PERFORM CONCEPT DEFINITION AND TRADE STUDIES INCLUDING ANALYTICAL MODELING WITH HEAT PIPE TECHNOLOGY; DESIGN, FAB., AND TEST FULL SCALE RADIATOR SEGMENT.

SPACE STATION SYSTEMS

ADVANCED PROGRAMS & PLANNING OFFICE

Lewis Research Center



Activity

Solar Dynamics

Space Station - Phase B
- Phase C/D

Space Station Solar Dynamic

Activities

Concentrators

Receivers

Radiators

Two-Phase Fluid Management

Fluid Stability

Rotary Fluid Mgm't Device

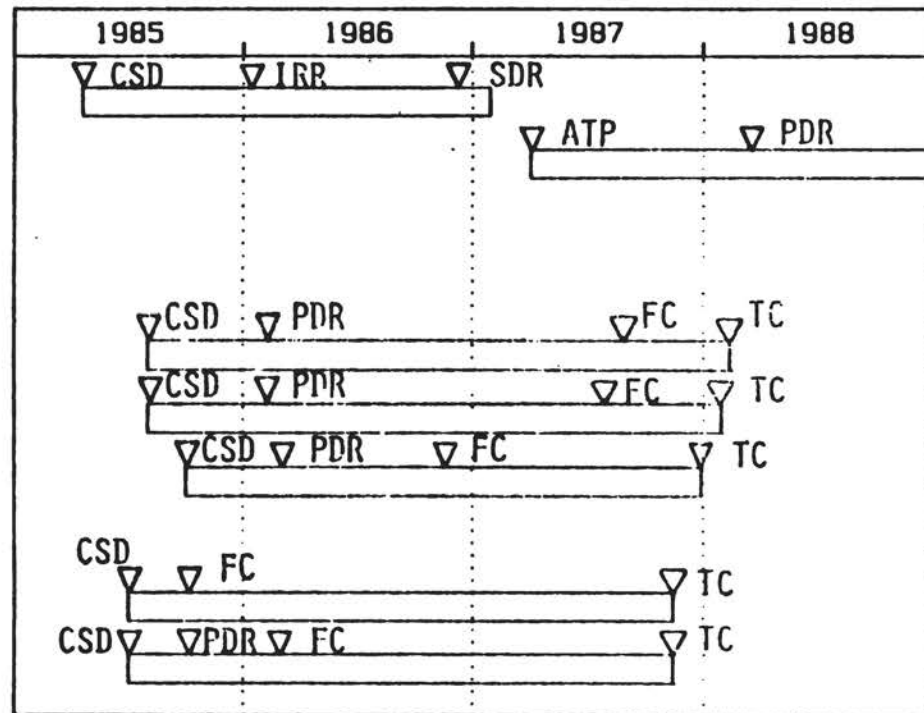

FC - Fabrication Completed
TC - Testing Completed

OASI

- IDENTIFY CRITICAL TECHNOLOGIES TO MEET FUTURE PROGRAM NEEDS
 - RESEARCH & DEVELOPMENT
 - TECHNOLOGY SPECIFIC

- JAST SOLAR DYNAMIC PROGRAM
 - ADVANCED, LOW AREA, HIGH EFFICIENCY NON-NUCLEAR ALTERNATIVES TO PHOTOVOLTAIC SYSTEMS
 - FOCUS BEYOND 1992
 - ASSESSING EXISTING STATE-OF-THE-ART

- COORDINATION WITH NASA IN-HOUSE ACTIVITIES AND CONTRACTORS

SPACE STATION SYSTEMS

ADVANCED PROGRAMS & PLANNING OFFICE

Lewis Research Center

NASA

SOLAR DYNAMIC SYSTEM PROGRAM

SUMMARY

TOTAL FUNDING FOR FY85, FY86, & FY87: \$14.1M

CONCENTRATOR	36%
RECEIVER	45%
RADIATOR	12%
TWO PHASE FLUID MANAGEMENT	7%

46

NASA IS PURSUING A VIGOROUS PROGRAM IN SOLAR DYNAMICS

SPACE STATION SYSTEMS
POWER SYSTEMS ENGINEERING DIVISION

Lewis Research Center

NASA

PRESENTATION OF LERC IN-HOUSE SOLAR DYNAMIC PROGRAM

TO THE

AERONAUTICS AND SPACE ENGINEERING BOARD

POWER SYSTEM ENGINEERING DIVISION

RICHARD L. PUTHOFF

JULY 31, 1985

SPACE STATION SYSTEMS

POWER SYSTEMS ENGINEERING DIVISION

Lewis Research Center



LERC IN-HOUSE SOLAR DYNAMIC PROGRAM

- 0 CONDUCT IN-HOUSE DESIGN AND ANALYSIS
- 0 CONDUCT SUBSYSTEM MANAGEMENT OF PHASE B CONTRACT ACTIVITY
- 0 MANAGE ADVANCED DEVELOPMENT CONTRACTS
- 0 DEFINE AND SYNTHESIZE REFERENCE SOLAR DYNAMIC POWER SYSTEM
- 0 CONDUCT IN-HOUSE TEST PROGRAM

SPACE STATION SYSTEMS

POWER SYSTEMS ENGINEERING DIVISION

Lewis Research Center

NASA

DESIGN/ANALYSIS ACTIVITIES

- 0 OBTAIN/DEVELOP DESIGN AND ANALYSIS SOFTWARE CODES
- 0 PROVIDE IN-HOUSE CAPABILITY TO CONDUCT CONCEPTUAL DESIGN AND DETAILED ANALYSIS OF ALL CANDIDATE SOLAR DYNAMIC SYSTEMS.
- 0 SYNTHESIZE SOLAR DYNAMIC SUBSYSTEM AND COMPONENT DATA OBTAINED FROM ADVANCED DEVELOPMENT PROGRAM, PHASE B CONTRACTORS, AND IN-HOUSE DESIGN ACTIVITY
- 0 FORMULATE A REFERENCE SOLAR DYNAMIC POWER SYSTEM
- 0 MAINTAIN REFERENCE SYSTEM AND UPDATE IN DATA BOOKS.

SPACE STATION SYSTEMS

POWER SYSTEMS ENGINEERING DIVISION

Lewis Research Center

NASA

IN-HOUSE TEST PROGRAM

TESTS USING EXISTING HARDWARE

- 0 ALTERNATOR/PMAD INTERACTION
- 0 20 FOOT DIAMETER CONCENTRATOR OPTICS
- 0 ATOMIC OXYGEN
- 0 RECEIVER MATERIAL COMPATIBILITY

ADVANCED DEVELOPMENT COMPONENT TESTS

- 0 RADIATOR THERMAL VAC
- 0 CONCENTRATOR SEGMENT OPTICS
- 0 RECEIVER THERMAL VAC
- 0 CONCENTRATOR/RECEIVER ASSEMBLY

POTENTIAL PHASE C/D TESTING

- 0 RECEIVER/ENGINE
- 0 CONCENTRATOR

**SPACE STATION SYSTEMS
POWER SYSTEMS ENGINEERING DIVISION**

Lewis Research Center

NASA

TESTS USING EXISTING HARDWARE

(NEAR TERM)

SPACE STATION SYSTEMS

POWER SYSTEMS ENGINEERING DIVISION

Lewis Research Center



ALTERNATOR/PMAD INTERACTION

OBJECTIVE: IDENTIFY THE SYSTEM INTERACTION BETWEEN THE POWER GENERATOR AND PMAD SYSTEM

DESCRIPTION:

- PHASE I
- 0 DEMONSTRATE STAND-ALONE OPERATION OF ONE BRU WITH PARASITIC LOAD CONTROLLER WHILE OPERATING AT A CONSTANT POWER OUTPUT FROM THE PRIME MOVER
- PHASE II
- 0 DEMONSTRATE PARALLEL OPERATION OF TWO BRU'S
 - 0 SYSTEM INTEGRATION BETWEEN BRU'S AND PMAD SYSTEM
 - LOAD SCHEDULING AND LOAD SHARING
 - 0 SYSTEM STABILITY DURING ELECTRICAL LOAD TRANSIENTS
 - STARTUP AND SHUTDOWN
 - SYNCHRONIZATION AND LOAD SHARING OF ALTERNATORS
 - FAULT ACCOMMODATION

SPACE STATION SYSTEMS

POWER SYSTEMS ENGINEERING DIVISION

Lewis Research Center

NASA

ALTERNATOR/PMAD INTERACTION (CONT'D)

DESCRIPTION:

- PHASE III 0 DEMONSTRATE OPERATION AND CONTROL OF BRU WITH AC/AC RESONANT CONVERTER
- 0 SYSTEM INTEGRATION OF PHOTOVOLTAIC AND S.D. POWER SOURCES WITH PMAD
- 0 ALTERNATOR VOLTAGE AND SPEED CONTROL REQUIREMENTS FOR HIGH-FREQUENCY (20 KHZ) PMAD SYSTEM

SPACE STATION SYSTEMS

POWER SYSTEMS ENGINEERING DIVISION

Lewis Research Center

NASA

20 FOOT DIAMETER CONCENTRATOR OPTICS TESTING

OBJECTIVE: TO DETERMINE THE CONCENTRATOR SURFACE SLOPE ERRORS AND OPTICAL PROPERTIES OF THE 20 FOOT AND/OR 30 FOOT DIAMETER CONCENTRATORS PREVIOUSLY MANUFACTURED FOR THE BRAYTON ENGINE FOR SPACE APPLICATIONS.

DESCRIPTION:

- 0 TEST CELL 180 OF BUILDING 16
- 0 ASSEMBLE THE 20 FOOT DIAMETER SECTIONS OF THE BRAYTON CONCENTRATOR AND TEST EQUIPMENT
- 0 MEASURE THE OPTICAL QUALITY OF THE CONCENTRATOR INCLUDING THE REFLECTANCE, EMITTANCE, ABSORPTANCE, AND ANY SPECULAR ERRORS.

SOLAR CONCENTRATOR OPTICAL TEST FACILITY
(BLD 16)

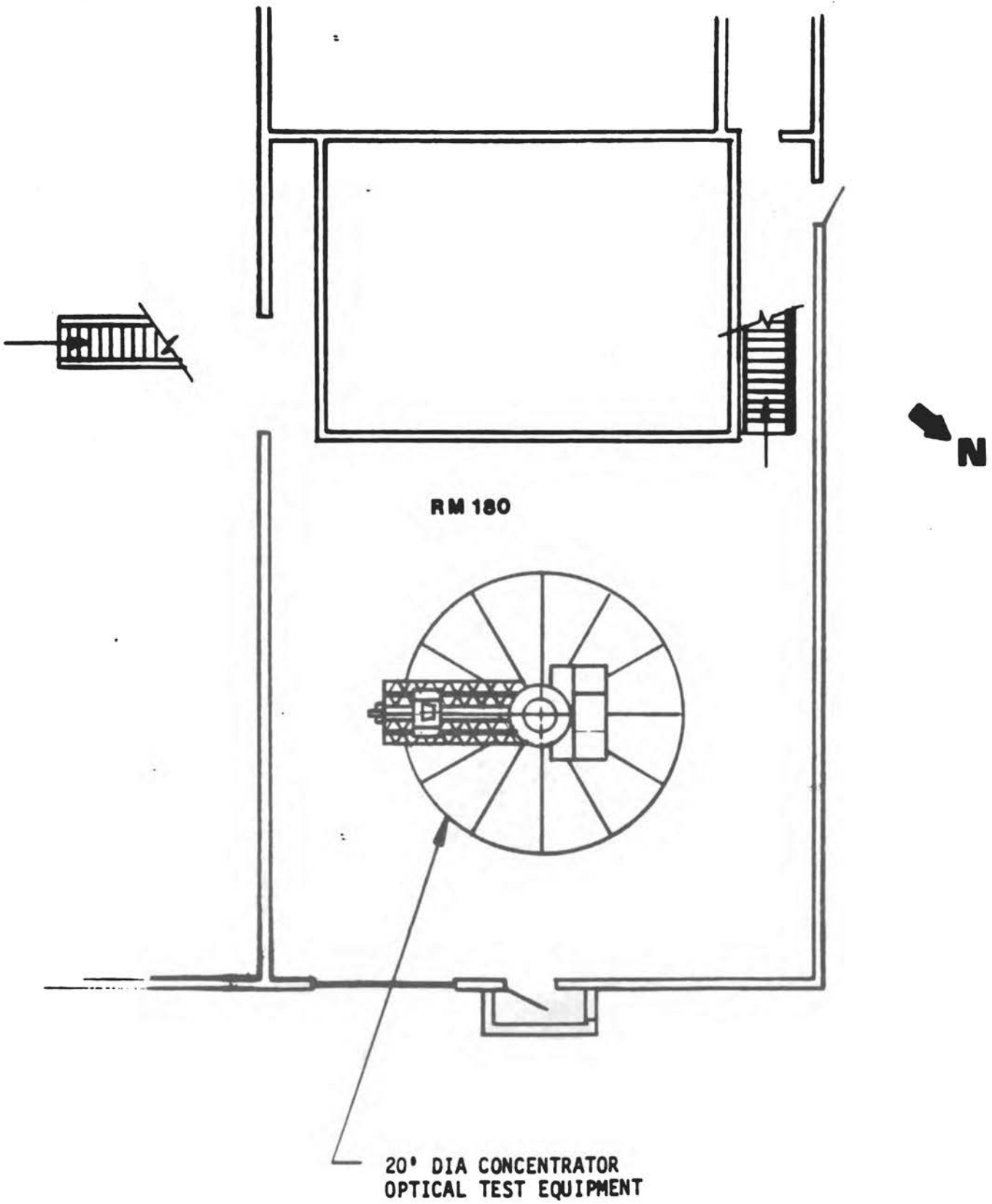

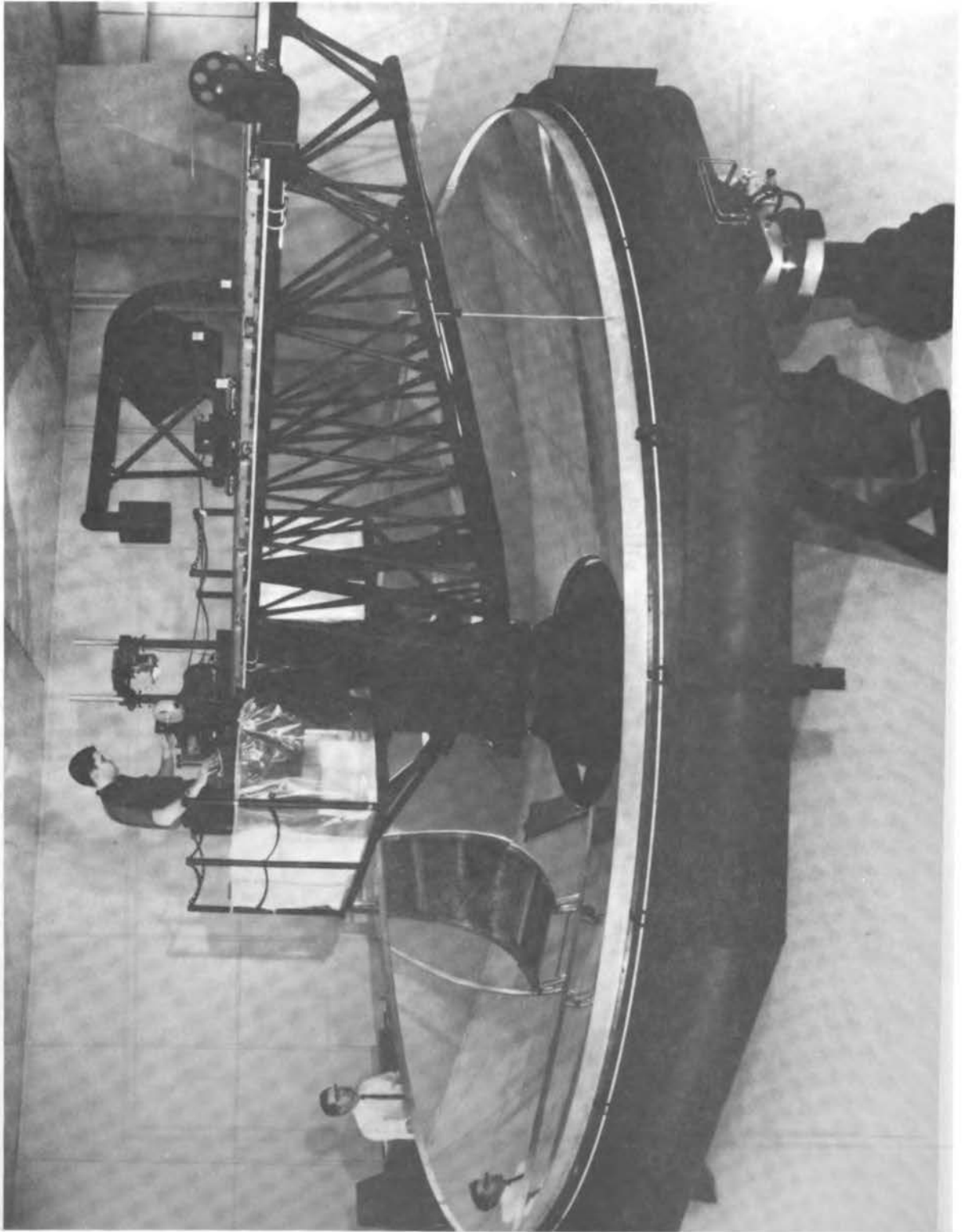

SPACE STATION SYSTEMS

POWER SYSTEMS ENGINEERING DIVISION

Lewis Research Center



ATOMIC OXYGEN TESTING

OBJECTIVE: TO ESTABLISH AN INDUSTRIAL CAPABILITY TO PRODUCE THIN FILM OXIDATION-PROTECTIVE COATINGS SUITABLE FOR SOLAR DYNAMIC POWER SYSTEM REFLECTOR SURFACES.

DESCRIPTION:

- o SIMULATE ATOMIC OXYGEN ENERGY AND DENSITY LEVELS OCCURRING AT 270 NAUTICAL MILES

- o EVALUATE VARIOUS COATINGS AND COATING TECHNIQUES TO MEET SOLAR DYNAMIC POWER SYSTEM REFLECTOR REQUIREMENTS.

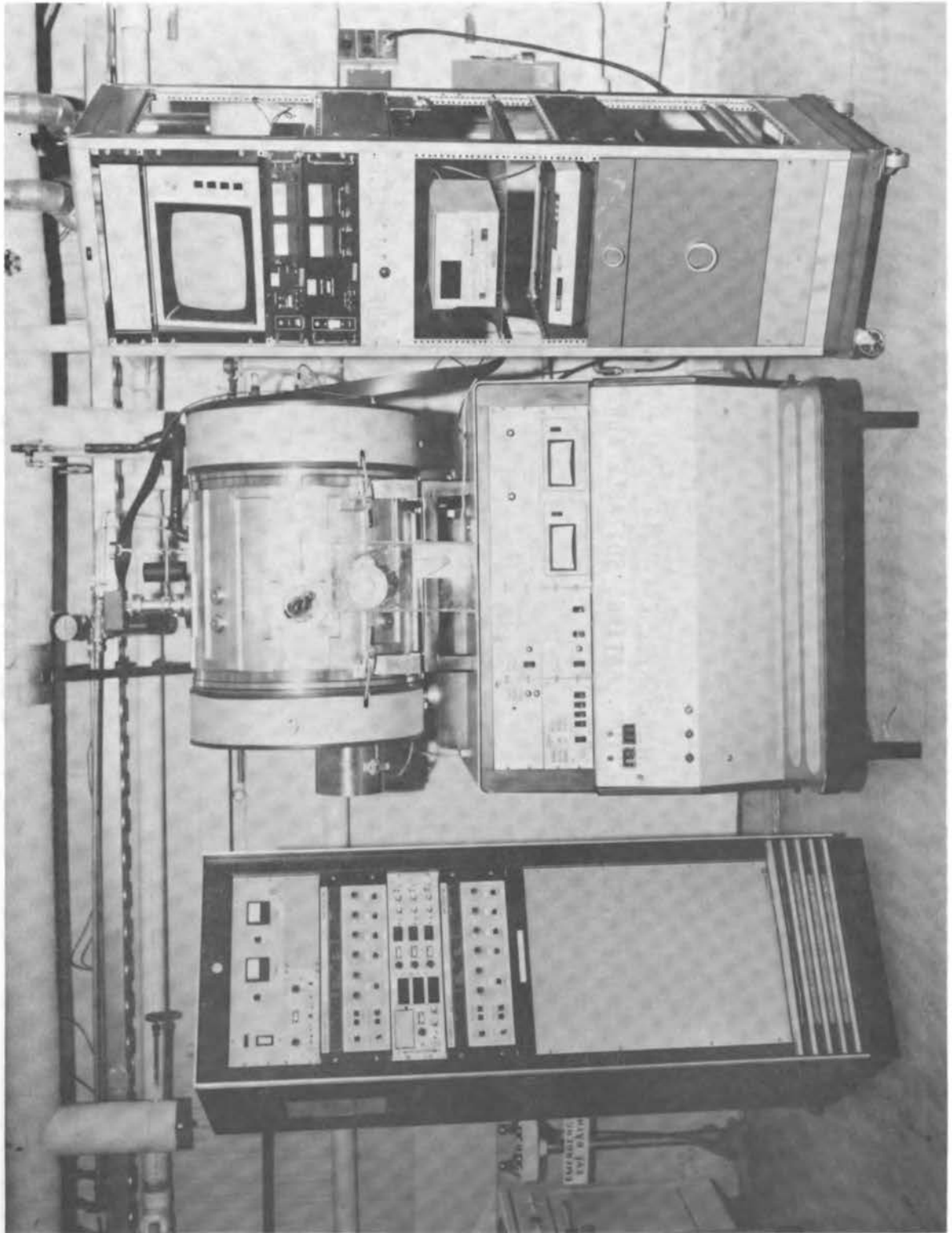

SPACE STATION SYSTEMS

POWER SYSTEMS ENGINEERING DIVISION

Lewis Research Center

NASA

RECEIVER MATERIALS COMPATIBILITY TESTS

OBJECTIVE: TO DETERMINE THE COMPATIBILITY OF POTENTIAL THERMAL ENERGY STORAGE SALTS WITH CONTAINMENT MATERIALS.

DESCRIPTION:

- o IMMERSE VARIOUS ALLOYS IN THERMAL ENERGY STORAGE SALTS
- o SUBJECT TO LONG-TERM THERMAL CYCLING BETWEEN TEMPERATURES REPRESENTING THE SOLID AND LIQUID PHASES OF THE SALT
- o FOLLOWING EXPOSURES OF UP TO 10,000 CYCLES IN A VACUUM OVEN, THE MECHANICAL PROPERTIES OF THE ALLOYS WILL BE DETERMINED.
- o INITIAL TESTING WILL EXAMINE THE COMPATIBILITY OF LIOH WITH COMMERCIALY PURE NICKEL ALLOYS. THIS COMBINATION IS APPROPRIATE FOR A HEAT RECEIVER FOR AN ORGANIC RANKINE CYCLE POWER CONVERSION UNIT.

SPACE STATION SYSTEMS

POWER SYSTEMS ENGINEERING DIVISION

Lewis Research Center

NASA

	1985	1986	1987	1988	1989	
IN-HOUSE TESTING: EXISTING HARDWARE						
SPACE STATION-PHASE B -PHASE C/D						
GENERATOR/PMAD TESTS						
BRU-F TESTS (AT ROCKETDYNE)						
20' CONCENTRATOR OPTICS TESTS						
ATOMIC OXYGEN TESTS						
RECEIVER MATERIALS COMPATIBILITY TESTS						
A-ASSEMBLY AND CHECKOUT						
T-TEST						

**SPACE STATION SYSTEMS
POWER SYSTEMS ENGINEERING DIVISION**



Lewis Research Center

ADVANCED DEVELOPMENT COMPONENT TESTS

FY 1987

SPACE STATION SYSTEMS

POWER SYSTEMS ENGINEERING DIVISION

Lewis Research Center

NASA

RADIATOR THERMAL VACUUM

OBJECTIVE: DEMONSTRATE THE THERMAL/MECHANICAL PERFORMANCE AND OPERATIONAL CHARACTERISTICS OF THE SOLAR DYNAMIC HEAT ENGINE RADIATOR.

- DESCRIPTION:
- o A HIGH CAPACITY/HIGH TEMPERATURE HEAT PIPE RADIATOR WILL BE THERMAL/VACUUM TESTED
 - o RADIATOR THERMAL/MECHANICAL PERFORMANCE WILL BE ASSESSED
 - o OPERATIONAL CHARACTERISTICS WILL BE DETERMINED OVER THE ORBIT THERMAL CYCLE INCLUDING SIMULATED SYSTEM STARTUP
 - o THE HEAT PIPE RADIATOR WILL BE INTEGRATED WITH THE TRANSPORT LOOP/HEAT EXCHANGER UNIT AND EVALUATED UNDER OPERATIONAL CONDITIONS.

SPACE STATION SYSTEMS

POWER SYSTEMS ENGINEERING DIVISION

Lewis Research Center

NASA

CONCENTRATOR SEGMENT OPTICS

OBJECTIVE: DETERMINE SURFACE SLOPE ERRORS AND OPTICAL PROPERTIES OF A FULL SIZE CONCENTRATOR SEGMENT

DESCRIPTION: 0 TEST IN CELL 180 OF BUILDING 16

0 MEASURE OPTICAL PROPERTIES OF SEGMENT ONLY - SPACE LIMITED

0 MEASURE REFLECTANCE, EMITTANCE, ABSORPTANCE, ETC.

0 COMPARE WITH DESIGN OBJECTIVES

SPACE STATION SYSTEMS

POWER SYSTEMS ENGINEERING DIVISION

Lewis Research Center

NASA

RECEIVER THERMAL/VACUUM TESTS

OBJECTIVE: TO DEMONSTRATE AND VERIFY THE OPERATIONAL CHARACTERISTICS OF THE SELECTED RECEIVER/THERMAL ENERGY STORAGE DEVICE.

- DESCRIPTION:
- 0 TEST IN A LARGE VACUUM TANK AT LEWIS WHERE ELECTRICAL HEATERS WILL BE USED TO SIMULATE THE SOLAR FLUX
 - 0 THE HEAT TRANSFER CHARACTERISTICS WILL BE MEASURED UNDER CONDITIONS SIMULATING BOTH DAYLIGHT AND ECLIPSE
 - 0 THE EFFECTS OF STARTUP AND SHUTDOWN WILL BE DETERMINED
 - 0 THE METHOD OF HANDLING EXCESS HEAT INPUT TO THE THERMAL ENERGY STORAGE SALT WILL BE DEMONSTRATED
 - 0 TESTS WILL BE CONDUCTED AT VARIOUS ORIENTATIONS TO VALIDATE THE PERFORMANCE OF THE THERMAL ENERGY STORAGE DEVICE IN THE 0-G ENVIRONMENT.

SPACE STATION SYSTEMS

POWER SYSTEMS ENGINEERING DIVISION

Lowie Research Center



CONCENTRATOR/RECEIVER TEST

OBJECTIVE: ASSEMBLE THE CONCENTRATOR AND RECEIVER DELIVERED UNDER THE ADVANCED DEVELOPMENT PROGRAM AND CONDUCT SOLAR HEAT FLUX PROFILE TESTING.

- DESCRIPTION:**
- o SOLAR HEAT SOURCE

 - o MEASURE HEAT FLUX INTO RECEIVER

 - o COMPARE WITH PREDICTED VALUES

 - o EVALUATE POINTING ERROR, SURFACE IRREGULARITY, AND VIBRATION EFFECTS

SPACE STATION SYSTEMS

POWER SYSTEMS ENGINEERING DIVISION

Lewis Research Center

NASA

IN-HOUSE TESTING: ADVANCED DEVELOPMENT COMPONENTS	1985	1986	1987	1988	1989	
<p>SPACE STATION- PHASE B - PHASE C/D</p> <p>RADIATOR THERMAL/ VACUUM TESTS</p> <p>OPTICS TESTS</p> <p>RECEIVER THERMAL/ VACUUM TESTS</p> <p>CONCENTRATOR/RECEIVER TESTS</p>						

A - ASSEMBLY AND CHECKOUT

T - TESTING

**SPACE STATION SYSTEMS
POWER SYSTEMS ENGINEERING DIVISION**



Lewis Research Center

PHASE C/D POTENTIAL TESTING

SPACE STATION SYSTEMS

POWER SYSTEMS ENGINEERING DIVISION

Lewis Research Center

NASA

RECEIVER/ENGINE TEST

OBJECTIVE: TEST PROTOTYPE HARDWARE IN A THERMAL VACUUM ENVIRONMENT AND OPERATING INTO THE PMAD SYSTEM.

- DESCRIPTION:
- o TEST PROTOTYPE HEAT RECEIVER AND ENGINE IN THE POWER SYSTEMS FACILITY AS AN ASSEMBLY
 - o THE POWER OUT OF THE ENGINE WILL BE CONNECTED TO THE PMAD SYSTEM
 - o CONDUCT DESIGN AND OFF-DESIGN TESTS

Lewis Research Center

POWER SYSTEMS FACILITY

INTEGRATED SOLAR DYNAMIC SYSTEMS TESTS

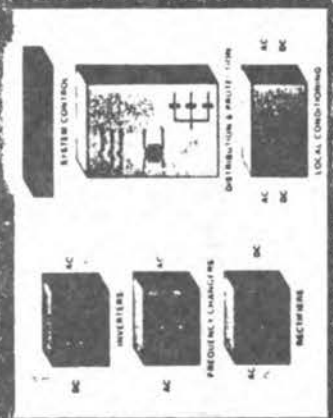
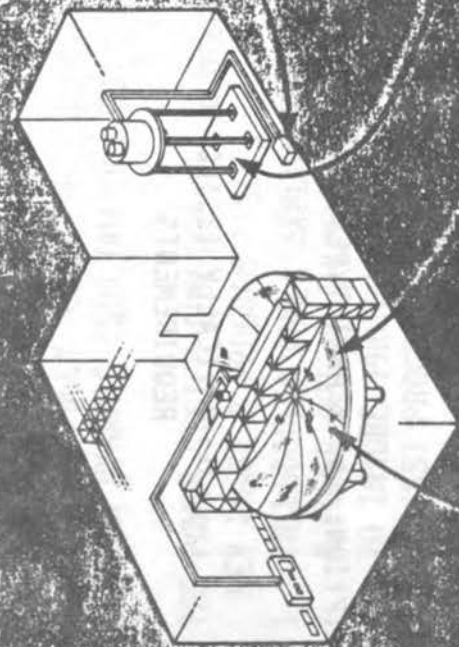

POWER CONVERSION/DISTRIBUTION/CONTROL

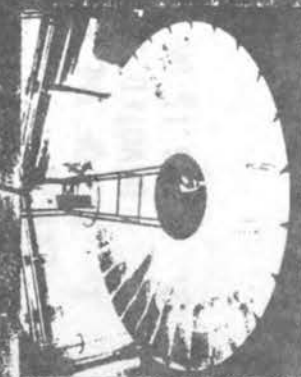

ASSEMBLY/VIBRATION



OPTICAL/POINTING/FOCUSING

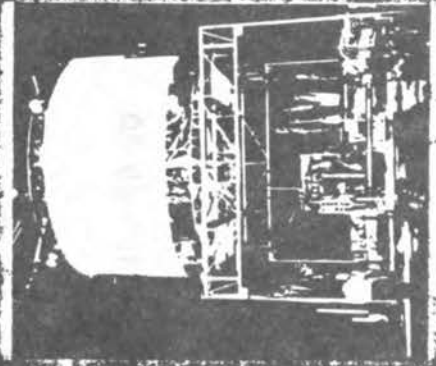

ELECTRICALLY HEATED
RECEIVER/HEAT ENGINE/ALTERNATOR
CS-B-16348

SPACE STATION SYSTEMS

POWER SYSTEMS ENGINEERING DIVISION

Lewis Research Center



CONCENTRATOR OPTICS TESTING

OBJECTIVE: A FULLY DEPLOYED CONCENTRATOR WILL BE OPTICALLY TESTED TO VERIFY THE ACCURACY OF THE COMPONENT.

DESCRIPTION:

- o A PROTOTYPE CONCENTRATOR WILL BE FULLY DEPLOYED/ASSEMBLED IN THE POWER SYSTEMS FACILITY

- o OPTICALLY TESTED TO DETERMINE IF IT MEETS THE DESIGN REQUIREMENTS.

PRESENTATION FOR THE ASEB
THE LEVEL B PERSPECTIVE

ENERGY SYSTEMS OFFICE

D. WEARY

JULY 31, 1985

I. COMMITMENT

- A. LEVEL B IS FULLY COMMITTED TO INSURE A COMPREHENSIVE EVALUATION OF THE SOLAR DYNAMIC (SD) OPTIONS FOR BOTH IOC AND GROWTH STATIONS

- B. THE POWER SYSTEM CONFIGURATION OPTION HAS BEEN ESTABLISHED AS ONE OF THE KEY PHASE B PROGRAM ISSUES
 - 1. INCLUDED IN THE ENGINEERING MASTER SCHEDULE (EMS) AS A MAJOR THEME
 - 2. A POWER OPTION THEME MANAGER HAS BEEN DESIGNATED
 - 3. TO INSURE PHOTOVOLTAIC-SD OPTIONS ARE STUDIED ACROSS THE SPACE STATION (SS) PROGRAM ELEMENTS

- C. THE SD ADVANCED DEVELOPMENT (AD) PROGRAM HAS BEEN SUPPORTED TO THE FULLEST EXTENT
 - 1. 34% OF THE FY86 POWER FUNDS (5150) AND 43% OF THE FY87 POWER FUNDS (5640) DEVOTED TO SD TASKS
 - 2. FOCUS IS ON ENERGY COLLECTORS, RECEIVERS, AND THERMAL STORAGE

PRESENTATION FOR THE ASEB
THE LEVEL B PERSPECTIVE

ENERGY SYSTEMS OFFICE

D. WEARY

JULY 31, 1985

- D. LEVEL B DELEGATED SE&I TASKS FOCUS ON THE POWER OPTION ISSUES.
 - 1. LARC
 - A. EVALUATION OF SD WITH RESPECT TO OTHER SS SYSTEMS
 - B. DEVELOPMENT OF A PV TO SD CHANGE-OVER PLAN INCLUDING SCARRING
 - 2. LERC
 - A. PV-SD TRADES WITH RESPECT TO OTHER SS SYSTEMS AND OPERATIONS
 - B. IOC IMPACT ASSESSMENTS
 - C. GROWTH PLAN IMPACTS AND ASSESSMENTS
 - D. OVERALL POWER SYSTEM ARCHITECTURE TRADE STUDIES
 - E. MODEL DEVELOPMENT FOR PV-SD TRADE STUDIES

- E. LEVEL B SE&I TASKS
 - 1. ENERGY SYSTEMS OFFICE STUDIES
 - 2. SYNTHESIS OFFICE STUDIES
 - A. COST EFFECTIVENESS ANALYSIS
 - B. INTEGRATED SS LEVEL SYSTEM STUDIES AND EVALUATIONS
 - 3. JSC ENGINEERING DIRECTORATE IS SUPPORTING THESE EFFORTS

PRESENTATION FOR THE ASEB
THE LEVEL B PERSPECTIVE

ENERGY SYSTEMS OFFICE

D. WEARY

JULY 31, 1985

II. LEVEL B APPROACH PHILOSOPHY

- A. DEFINITION OF NEAR TERM AND LONG TERM SS LEVEL BENEFITS
- B. DEFINITION OF MISSION AND POWER REQUIREMENTS
 - 1. CUSTOMER REQUIREMENTS
 - 2. IMPACT OF POWER OPTIONS ON SS ELEMENTS
 - 3. MISSION STUDIES - (HOW THE SYSTEMS ARE ASSEMBLED, USED AND MAINTAINED)
- C. QUANTIFY THE SCHEDULE AND COST RISKS
 - 1. MISSION STUDIES - (EPS ASSEMBLY, USE AND MAINTENANCE)
 - 2. EPS FAILURE AND MAINTENANCE AND STUDIES
 - 3. TECHNOLOGY ISSUE EVALUATIONS
- D. VIGOROUS TECHNOLOGY DEVELOPMENT PROGRAM
- E. DEVELOPMENT OF SD IOC IMPLEMENTATION PLAN, A PV-SD CHANGEOVER GROWTH PLAN,
AND A LONG RANGE GROWTH PLAN - (INCLUDING NUCLEAR POWER OPTIONS)

PRESENTATION FOR THE ASER
THE LEVEL B PERSPECTIVE

ENERGY SYSTEMS OFFICE

D. WEARY

JULY 31, 1985

- F. NARROW POWER OPTIONS AS QUICKLY AS POSSIBLE
 - 1. EMS GOAL IS AN IRR DECISION
 - 2. TRADE STUDIES, ANALYSIS, TECHNOLOGY ASSESSMENT STUDIES, AD PROGRAMS STUDIES AND DESIGN WORK, WILL SUPPORT AN IRR DECISION

- G. FOCUS POST-IRR EFFORTS ON PRELIMINARY DESIGN AND DEVELOPMENT OF SELECTED POWER OPTION TO REDUCE COSTS AND RISKS
 - 1. AD PROGRAM WILL FOCUS ON TESTING OF HARDWARE AND DEVELOPMENT OF NECESSARY TECHNOLOGY
 - 2. PHASE B CONTRACTOR WILL FOCUS ON EPS PRELIMINARY DESIGN

PRESENTATION FOR THE ASEB
THE LEVEL B PERSPECTIVE

ENERGY SYSTEMS OFFICE

D. WEARY

JULY 31, 1985

III. IMPLEMENTATION ACTIVITY WITH RESPECT TO THE POWER OPTION THEME

A. LEVEL B

1. CUSTOMER INTEGRATION OFFICE - (REQUIREMENT DEFINITION AND MISSION MODELS)
2. OPERATIONS OFFICE DEFINITION AND ANALYSIS EFFORTS
3. SE&I OFFICE STUDIES - (ALL DISCIPLINE OFFICES)
4. EMS PRODUCT EVALUATIONS AND PRODUCT GENERATION
5. DELEGATED SE&I TASKS (LERC, LARC)
6. PROGRAM CONTROL OFFICE - (COST ANALYSIS STUDIES)

B. WP1

1. LOGISTICS CONSIDERATIONS
2. COMMON MODULE POWER MANAGEMENT AND DISTRIBUTION (PMAD)
3. COMMONALITY
4. PROX OPS ANALYSIS
5. REBOOST ANALYSIS

PRESENTATION FOR THE ASEB
THE LEVEL B PERSPECTIVE

ENERGY SYSTEMS OFFICE

D. WEARY

JULY 31, 1985

C. WP2

1. OVERALL SS ARCHITECTURE
2. RESOURCE INTEGRATION
3. GROWTH PATH ANALYSIS
4. PROX OPS ANALYSIS
5. DRAG ANALYSIS
6. CONTROLLABILITY/POINTING ANALYSIS
7. ASSEMBLY ANALYSIS

D. WP3

1. PLATFORM COMMONALITY ANALYSIS
2. FIELD OF VIEW ANALYSIS

PRESENTATION FOR THE ASER
THE LEVEL B PERSPECTIVE

ENERGY SYSTEMS OFFICE

D. WEARY

JULY 31, 1985

- E. WP4
 - 1. POWER SYSTEM DEFINITION AND TRADE STUDIES
 - 2. POWER OPTION IMPACTS ON SS ELEMENTS
 - 3. GROWTH PATH ANALYSIS
 - 4. TECHNOLOGY DEVELOPMENT
 - 5. SD-PV COMPARISON ANALYSIS
 - 6. AD PROGRAM AND RISK ANALYSIS
 - 7. COST ANALYSIS

- F. INTERNATIONAL
POWER SYSTEMS REQUIREMENTS

APPENDIX C

Electric Power Generation Technology Development Studies
Procurement Status as of July 31, 1985

<u>Title and Contractor</u>	<u>Contract Award Date</u>
Solar Dynamic Power System Engineering Analysis and Design Study--Cleveland State University	05-07-85
Study of a Solar Dynamic Induction Generator--University of Wisconsin	04-01-85
Two Phase Fluid Management and Fluid Stability Techniques	--
Solar Dynamic Concentrator Technology	--
Electric, Operating, and Mechanical Properties of Composite Materials--Cleveland State University	04-02-85
Solar Dynamic Heat Receiver Technology	--
High Frequency AC System--General Dynamics	03-21-85
High Power Factor Transformer Technology--California Institute of Technology	02-19-85
High Frequency AC System--GD/C Inc.	01-04-85
Advanced Topology High Power Converter--TRW	03-29-85
Semiconductor Packaging	--
High Frequency Transmission Line--Induction General Corporation	11-26-84
AC RPC	--
VOLT Solar Cell Modules	--
NASCAP LEO Development--S Cubed Corporation	10-31-84
Array Parameter Evaluation	--
Array Response to Arcs--Colby College	11-09-84
Improved Silicon Cell Technology	--
Regenerative Fuel Cell Component Technology--United Technologies Corporation/International Fuel Cells	11-09-84
Electrolysis Unit Endurance Test--Life Systems Inc.	12-13-84

